



GROB-FLUGZEUGBAU
8939 Mattsies
Flugplatz Mindelheim-Mattsies
Telefon 08268/411

FLIGHT HANDBOOK

TWIN-ASTIR

This handbook must be carried on board at all times.

It refers to the TWIN ASTIR Sailplane

Registration: F-CPVI

Factory Serial Number: 3147

Owner: AAVA

German edition of operating instructions are approved under § 12/2.
of LuftGerPO.

Published May 1978

Approval of translation has been done by best knowledge and judgement — In any case the
original text in German language is authoritative.

Annexe 1



Cet intercalaire doit obligatoirement être inséré
devant la page de garde d'un manuel de vol en
langue anglaise

AVERTISSEMENT

Le présent document en langue anglaise est le manuel de vol approuvé par l'Agence européenne de la sécurité aérienne.

En application des dispositions de l'arrêté du 24 juillet 1991 relatif aux conditions d'utilisation des aéronefs civils en aviation générale (« Un vol ne peut être entrepris que si, d'une part les membres d'équipage sont familiarisés avec l'aéronef et son équipement de bord, notamment le matériel de sécurité-sauvetage et les systèmes spéciaux, et d'autre part ont une connaissance pratique de son manuel de vol ou des documents acceptés comme équivalents. »),

Nul ne peut utiliser l'aéronef avec ce seul document s'il n'a pas une connaissance suffisante de la langue anglaise.

A défaut, il appartient au propriétaire ou à l'exploitant de l'aéronef de se procurer une traduction de ce document sous sa responsabilité.

Référence : Instruction du 13/11/2009 relative à la langue des manuels de vol



GROB-FLUGZEUGBAU
8939 Mattsies
Flugplatz Mindelheim-Mattsies
Telefon 08268/411

FLIGHT HANDBOOK
TWIN-ASTIR
TRAINER

This handbook must be carried on board at all times.

It refers to the TWIN-ASTIR TRAINER Sailplane

Registration:

Factory Serial Number:



Owner:

German edition of operating instructions are approved under § 12/2.
of LuftGerPO.

Published May 1978

Approval of translation has been done by best knowledge and judgement — In any case the
original text in German language is authoritative.

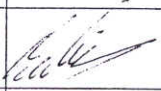
Updates

Current number	Page	Reference	Date	Signature	LBA - Approval
1	5a	TWIN ASTIR TRAINER	1.4.78		
2	17	New Control Levers	1.10.78		
3	18	New Control Levers	1.10.78		
4	25	Check of wing	1.10.78		
5	25a	Fittings	1.10.78		
6	1, 28	Service Bulletin 315-50	28.09.92		
7	1, 25, 25a	TM 315-58	04.11.96		
8	1, 7, 11	ASB 315-64 Envelope Limitations	30.06.2003		
9	1, 7, 11	MSB 315-64/3 Revised Limits of Operation	14.09.2004		12. OKT. 2004 

14 September 2004

Contents

I.	General	
I. 1	Updates	1
I. 2	Contents	2
I. 3	Photograph	4
I. 4	Drawing	5
I. 5	Description	6
II.	Operating limits	
II. 1	Airworthiness Group	6
II. 2	Permitted operating conditions	6
II. 3	Minimum equipment	6
II. 4	Maximum Speeds	7
II. 5	Flight envelope	7
II. 6	Weight limits	8
II. 7	Centre of gravity position	8
II. 8	Load scheme	8
II. 9	Tow hooks	10
II. 10	Weak link strength	10
II. 11	Tire pressure	10
II. 12	Crosswinds	10
II. 13	Required placards	11
II. 14	Symbols	13
III.	Emergency procedures	
III. 1	Exit from a spin	15
III. 2	Emergency canopy jettisoning and exit	15
III. 3	Landing with a retracted undercarriage	15
III. 4	Others (Rain, ice, stall, groundloops)	15
III. 5	Instruments specifications	16

IV.	Normal operation	
IV. 1	Cockpit and controls (Picture)	17
IV. 2	Daily preflight inspection	19
IV. 3	Control checks before take off	21
IV. 4	Take off	21
IV. 5	Free Flight	22
IV. 6	Slow flying and stalls	22
IV. 7	High speed flight	22
IV. 8	Cloud flying	22
IV. 9	Simple Aerobatics	23
IV. 10	Approach and landing	24
IV. 11	Flying with waterballast	24
V.	Rigging and derigging	
V. 1	Rigging, derigging	25
V. 2	Storage	26
V. 3	Transport	27
V. 4	Maintenance of the glider	27
VI.	Appendices	
VI. 1	Flight performance	29
VI. 2	Service and Maintenance instructions	30
VI. 3	Reference to repairs	31
VI. 4	Reference to release hooks	31
VI. 5	Determination of the center of gravity	31

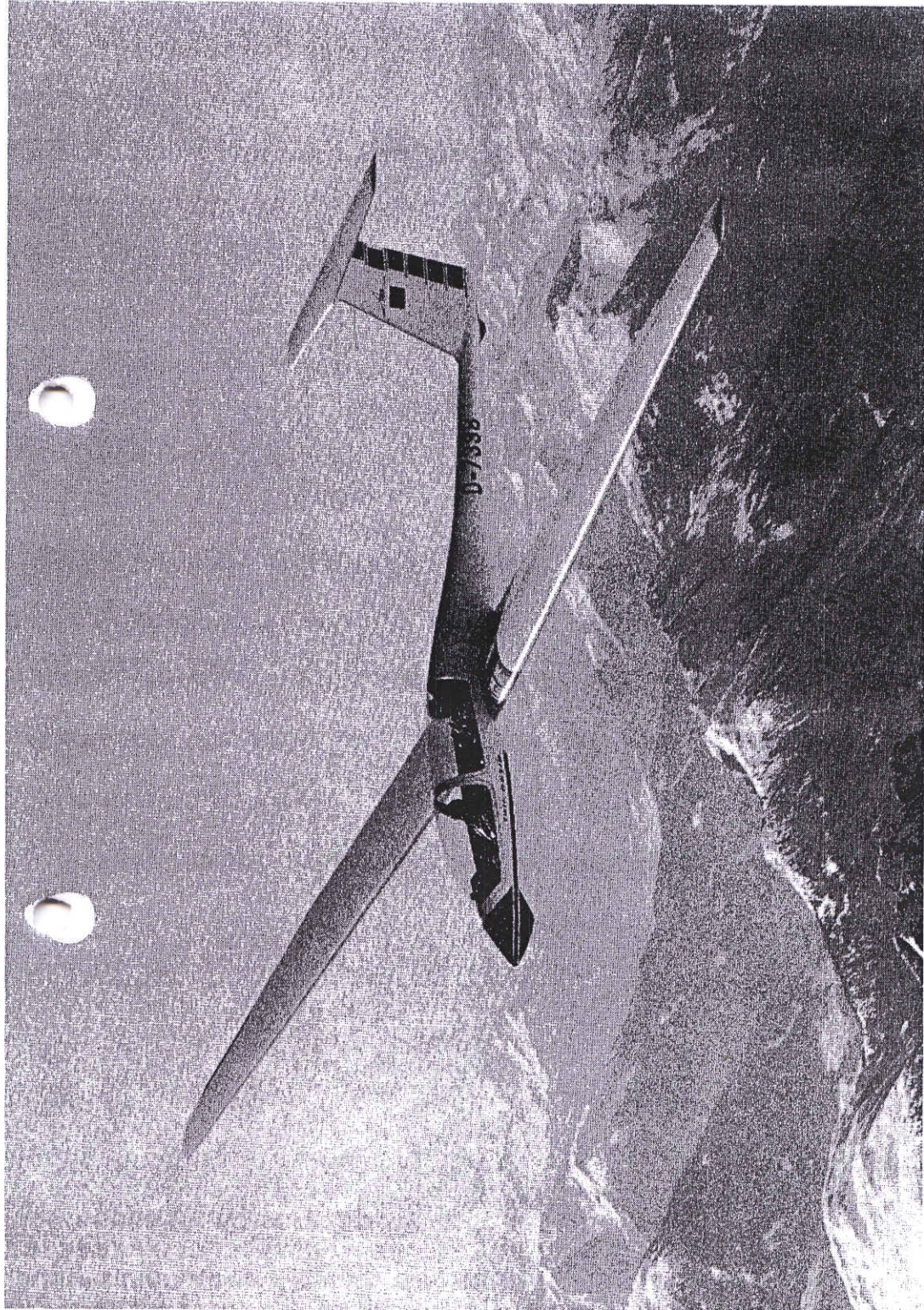

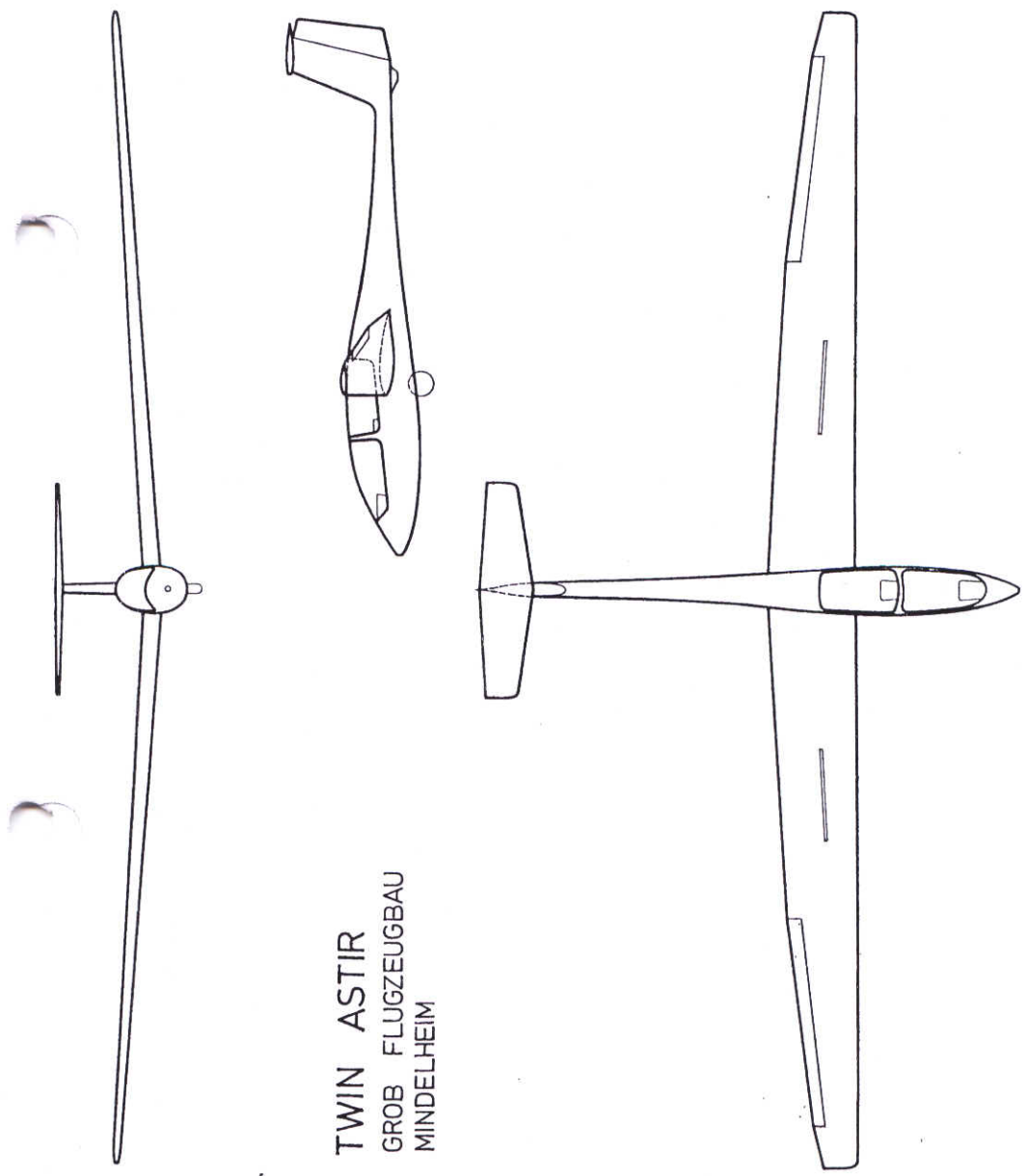

TWIN ASTIR
GROB FLUGZEUGBAU
MINDELHEIM

The sailplane TWIN-ASTIR TRAINER is derived from the TWIN-ASTIR. The differences are fixed sprung undercarriage with disc brake, and the deletion of the wing ballast tanks.

Therefore, the remarks in the flight handbook and the maintenance handbook concerning retractable undercarriage and water tanks do not apply to the TWIN-ASTIR TRAINER.

The wheel brake of the TWIN-ASTIR TRAINER is a disc brake. The brake cylinder with the storage tank for brake fluid is mounted on the undercarriage box.

The marks for minimum and maximum reserve must be observed. For refilling use brake fluid DOT 3 (amber).

I. 5 Description

The TWIN ASTIR is a high performance two seater sailplane with a T-tail, fitted with a retractable undercarriage, upper surface airbrakes and water ballast tanks in the wings.

This sailplane is manufactured using the latest techniques in industrial Glass fibre construction.

It is designed for training, high performance and simple aerobatic flying.

Technical Data:

Span	17.5 m (57.4 ft.)	Wing Area	17.8 m ² (191.6 ft. ²)
Length	8.1 m (26.6 ft.)	Maximum Flying Weight	650 kg (1435 lbs)
Height	1.6 m (5.2 ft.)	Maximum Wing Loading	36.5 kg/m ² (7.84 lbs/ft. ²)
Aspect Ratio	17.1		

II. Operating Limits

II. 1 Airworthiness Group

(U, Utility, LFSM)

The LFSM (Lufttüchtigkeitsforderung für Segelflugzeuge und Motorsegler) published 23. 10. 1975 are the basic rules and requirements for the licensing of a new type of glider or motor glider in Germany.

II. 2 Permitted operating conditions.

The plane is licensed for:

1. Flight in VMC
2. Simple Aerobatics (Loops, Stall turns, Lazy eight, Chandelle and Spin).
3. Cloud flying (When fitted with suitable instrumentation as defined in section II. 3).

II. 3 Minimum equipment

1. 2 Air speed Indicators reading to 300 km/hr (162 kts, 187 mph)
2. 2 Altimeters.
3. Full Harness Straps in front and back cockpit.
4. Parachute or back cushion at least 7 cm (3 inch) thick.
5. Loading limit plaque in front and back cockpit.
6. Flight Limits plaque.
7. Flight Handbook.

Cloud Flying.

For cloud flying the additional instruments listed below must be installed.

1. Variometer.
2. Electric turn and slip indicator.
3. Magnetic Compass (Compensated inside the glider).

II. 4 Maximum Speeds

Maximum permitted speed in calm air	$V_{NE} = 250 \text{ km/h (135 kts, 155 mph) }$	█
Maximum permitted speed in rough air	$V_B = 170 \text{ km/h (92 kts, 105 mph) }$	
Maximum Manoeuvring speed	$V_M = 170 \text{ km/h (92 kts, 105 mph) }$	
Maximum winch launch speed	$V_W = 120 \text{ km/h (65 kts, 74 mph) }$	
Maximum Aerotow speed	$V_T = 170 \text{ km/h (92 kts, 105 mph) }$	

Conditions in rough air are similar to those encountered in rotors, clouds, whirlwinds and when overflying mountain ranges.

Manoeuvring speed is the maximum speed at which full control deflections may be used. At maximum speed (V_{NE}) the control deflections should be restricted to 1/3 of the full range.

Air speed indicator markings

51–105 mph = 44 — 92 kts = 82 — 170 km/h	— Green arc	
105–155 mph = 92 — 135 kts = 170 — 250 km/h	— Yellow arc	
at 155 mph = 135 kts = 250 km/h (MSB315-64/3)	— Red line	█
at 65 mph = 55 kts = 102 km/h	— Yellow triangle	
	(recommended minimum appr. speed)	

Position Errors

The airspeed indicator must be connected to the following sources: Pitot head in the tail fin, static vents side of the fuselage between the two seats.

Using a calibrated ASI the position error is not greater than $\pm 2 \text{ km/h}$ or 1 kt or 1.2 mph. A calibration curve is therefore not necessary.

II. 5 Flight envelope.

The sailplane design limit load factors are as follows:

At manoeuvring speed	+ 5.3 — 2.65
At V_{NE}	+ 4.0 — 1.5
(Brakes closed and calm air)	

II. 6 Weight limits

Maximum permitted weight without water ballast	650 kg (1435 lbs)
Including water ballast	650 kg (1435 lbs)
Maximum permitted weight of non lifting parts .	470 kg (1036 lbs)

II. 7 Centre of gravity position

The approved range of centre of gravity positions during flight is 260 mm (10.24 inches) to 460 mm (18.11 inches) behind the reference point, equivalent to 24.7% to 43.6% of the M.A.C. of the wing.

The reference point is the front edge of the wing at the wing root.

The approved centre of gravity range does not get exceeded by the payload distribution specified in the loading plan II. 8.

The exact position of the centre of gravity at flying weight can be calculated according to VI. 5.

II. 8 Load scheme TWIN ASTIR

Minimum load in the front seat for all flight	70 kg (154 lbs)
Maximum load in the front seat	110 kg (242 lbs)
Maximum load in the back seat	110 kg (242 lbs)
Maximum load in both seats	220 kg (485 lbs)
Maximum load in the baggage compartment	10 kg (22 lbs)

Ballast must be used on the front seat to compensate if the front seat load is lower than 70 kg (154 lbs).

The maximum flying weight of 650 kg (1435 lbs) must not be exceeded.

Waterballast may only be taken on until the maximum flying weight is reached.

Water ballast can not be used to compensate if the load in the front seat is too low.

II. 9 Tow hooks

For Aerotow: Nose hook "E 75".

For Winch launch: Safety back release hook "G 73".

The E 75 and the G 73 Tost hooks are limited to 36 months after installation or 2000 launches whichever ever occurs first, at which time they are to be recertified by the manufacturer.

II. 10 Weak link strength recommended

Winch launch and aerotow *max 845 daN 1357 Lbs*
(ie. Tost weak link colour code black-red) ~~600 ± 30 kg~~ 1323 ± 66 lbs
TM 315-19

II. 11 Tire Pressure

Tire size 5.50-5 2,5-2.8 atm. 35,6-39,8 PSI

II. 12 Crosswinds

The maximum crosswind component approved for take off and landing, is 20 km/h (11 kts, 12 mph).

II. 13 Required placards front and rear cockpit

Maximum flying weight				
Without Waterballast		650 kp	1435 lbs	
With Waterballast		650 kp	1435 lbs	
Airspeed limits				
		km/hr	knots	mph
Never exceed	V_{NE}	250	135	155
In Rough Air	V_B	170	92	105
On Airtow	V_T	170	92	105
On Winch or Auto Launch	V_W	120	64	74
Airbrakes Open	V_{DF}	250	135	155
Manoeuvring	V_A	170	92	105
Payload (Pilot and Parachute)				
Minimum in Front cockpit for all flight		70 kg	154 lb	
Less must be compensated with ballast secured in the seat				
Maximum load front		110 kg	242 lb	
Maximum load back		110 kg	242 lb	
Simple aerobatics air speeds				
Recommended entry speed		km/hr	knots	mph
Loop		180	97	111
Stall turn		180	97	111
Spin		80	43	50
Chandelle		170	92	105
aerobatics with waterballast is not allowed				

Required placards**Check before launch**

Full and free movement of controls?
Parachute secured?
Straps tight and locked?
Pedals adjusted and locked?
Brakes closed and locked?
Trim correctly adjusted?
Altimeter adjusted?
Canopy locked?
Cable on correct hook?
Beware: – Crosswind! – Cable break!

Front Cockpit

Canopy Jettison and Emergency Exit

- Pull red handles on right and left of canopy fully back together
- Push canopy up and away with the left hand
- Release safety harness
- Stand up and get out over left or right side depending on the altitude
- When using a manual parachute grip release and pull firmly to full extent after 1–3 seconds

By canopy release front and back

Tire Pressure
39,8 PSI 2,8 atm
Maximum weak
link strength
1323 lbs 600 kg

Left undercarriage door.

Baggage maximum**22 lbs 10 kg**

Baggage compartment

II. 14 Symbols

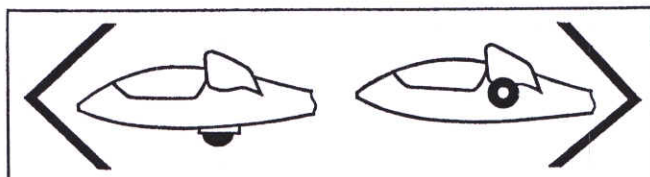

Undercarriage retract

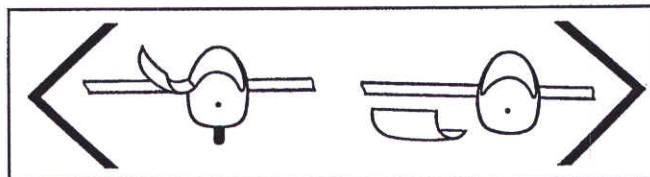

**Canopy open
Canopy jettison**



Waterballast jettison



Trim

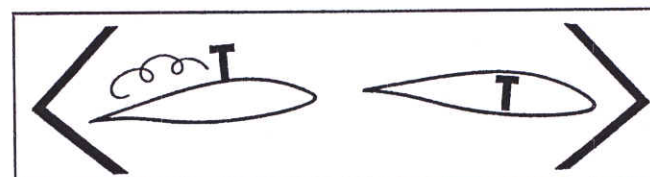

Airbrakes

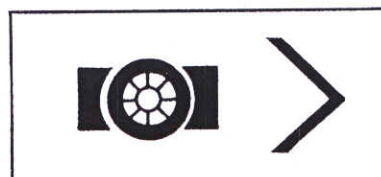

Wheelbrake

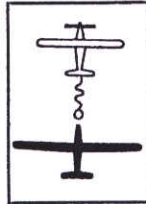
Symbols**Cable release****Air-vent**

Top left of front
instrument panel

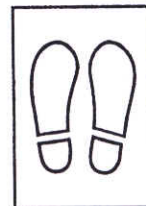
**Pedal adjustment**

Top right of front
instrument panel

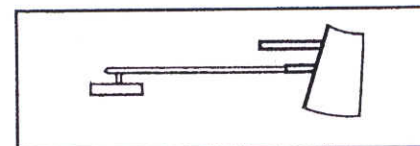
**Total energy
compensation tube**

III. Emergency procedures

III. 1 Exit from a spin

Exit from a spin can be accomplished by

- Full opposite Rudder
- Neutralise Stick
- Ailerons should be central
- When rotation stops centralise rudder and pull out gently.

III. 2 Emergency canopy jettisoning and exit.

The spacious cockpit allows unhindered exit in an emergency. It is advisable to keep to the following order:

- a) Pull red handles on left and right back together and push canopy upwards and away with the left hand.
- b) unlock safety belts
- c) Stand up and get out over left or right side depending on the attitude.
- d) When using a manual parachute grip release handle and pull firmly to full extent after 1 – 3 seconds.

III. 3 Landing with retracted undercarriage

It is possible on hard and soft ground without risk of overturning. Approach as normal and touch down on two points.

III. 4 Others

Flying in rain

Wet or lightly iced wings have little noticeable effect on flying. Thick ice deposits on the wing increase the stalling speed by about 10 km/h = 6 kts.

Stall

Stall out of straight flight or a turn: Neutralise stick and opposite rudder to any turn.

Ground Loops

The glider has no tendency to ground loop whilst taking off. However if a wing touches or the direction changes by more than 15 degrees during a take off release immediately.

III. 5 Instruments specifications

Basic equipment: Airspeed

The installation error of an airspeed indicator is not greater than 2 km/h or 1 kt. or 1,2 mph using the pitot tube in the tail fin and the static vents side of the cockpit.

The original certification was carried out using a Winter 6FMS4-2 and a PZL PR 400 S Airspeed indicator.

A similiar FAA approved airspeed indicator to meet TSO C 2 reading to 300 km/h (162 kts, 187 mph) may be used.

Altimeter

The original certification was carried out using a Winter 4FGH 10 and a PZL 12 S Altimeter.

A similiar FAA approved altimeter to meet TSO C 10 with a range to 35.000 feet may be used.

IV. Normal operation

VI. 1 Cockpit and controls

Front Seat.

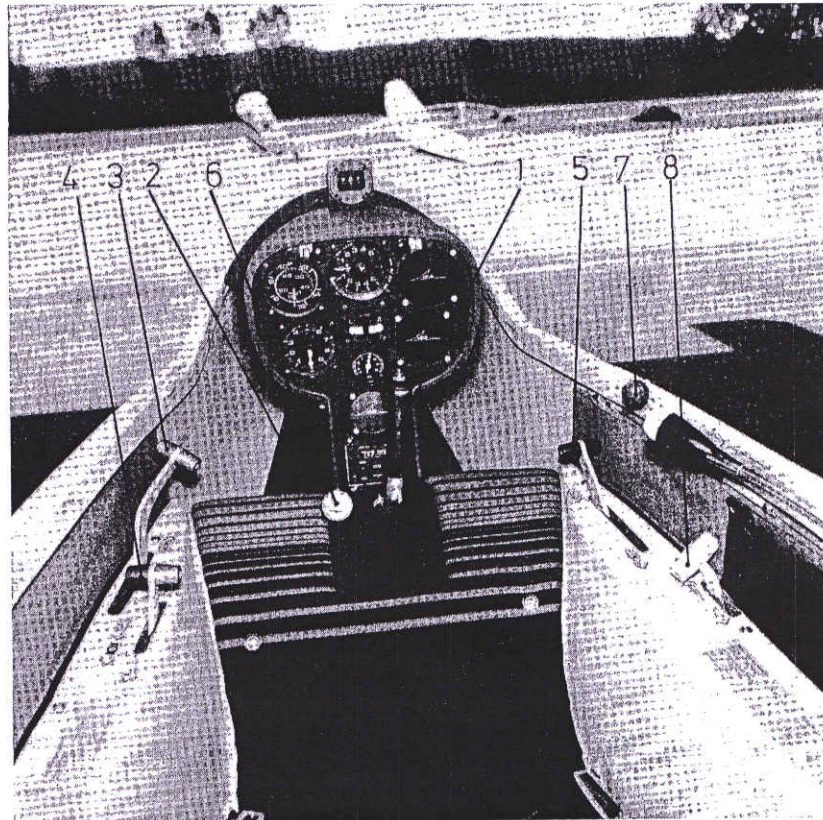

- | | |
|---------------------------------|--------------------------|
| 1 Stick | 5 Undercarriage lever |
| 2 Rudder pedals | 6 Release knob |
| 3 Airbrake lever and wheelbrake | 7 Canopy jettison |
| 4 Trim lever | 8 Water ballast jettison |

Ventilator top of instrument panel left side

Rudder pedal adjustment top of instrument panel right side.

IV. 1 Cockpit and controls

Back seat.

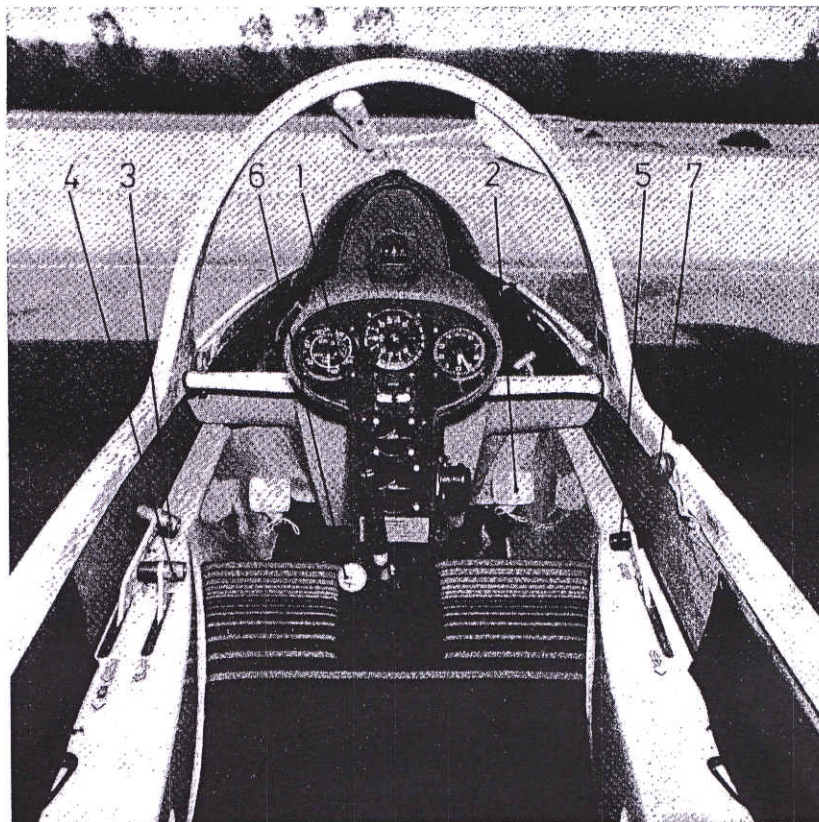

- | | |
|---------------------------------|-----------------------|
| 1 Stick | 4 Trim lever |
| 2 Rudder pedals | 5 Undercarriage lever |
| 3 Airbrake lever and wheelbrake | 6 Release knob |
| | 7 Canopy jettison |

IV. 2 Daily preflight inspection

1.
 - a) Open canopy.
 - b) Check the 4 wing fastenings inside the fuselage if locked.
 - c) Visually check all controls inside the cockpit.
 - d) Check for foreign bodies.
 - e) Test controls for full and free movement.
 - f) Check tire pressure 2.5 – 2.8 atm. = 35.6 — 39.8 PSI
 - g) Check condition of both hooks.
 - h) Check functioning of releases and wheelbrake.
2.
 - a) Check top and bottom of wing for damage.
 - b) Check ailerons for condition, freedom of movement and play.
 - c) Check airbrakes for condition, locking and fit.
3. Check fuselage for damage especially on the underside.
4. Check tail unit for correct assembly and that safety lock is in position.
5. Check condition of the tailskid.
6. Check the pitot tube, total energy venturi and static vents are clean.
7. Repeat step 2 for right wing.
8. Check static vents.

After heavy landings or excessive flight loads the entire glider should be checked. The wings and tailplane should be removed for these checks and if any damage is found an inspector should be consulted. The plane should not be flown before any damage is repaired.

**Preflight Inspection Checkpoints
compare IV.-2**

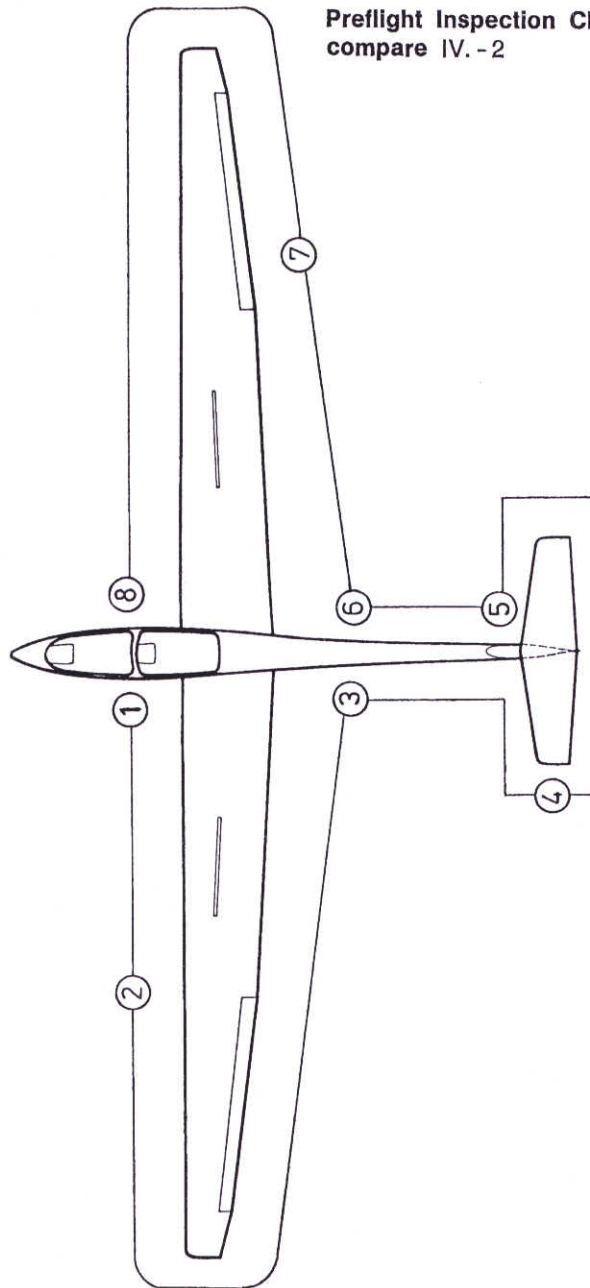

IV. 3 Control checks before take off

1. Check all the controls for full and free movement.
2. Check undercarriage lever is fully forward and locked down.
3. Check that the ballast limitations are being adhered to.
4. Check safety straps and parachute are firmly fastened.
5. Check altimeter is adjusted to zero or airfield height.
6. Check that transmitter is switched on and set to airfield frequency.
7. Check trim is neutral.
8. Check canopy is closed and locked.
9. Check airbrakes are closed and locked.

IV. 4 Take off

Winch launch

Trim lever should be in central position.

Maximum winch launch speed is 120 km/h (65 kts, 74 mph).

The glider has a release hook in front of the wheel.

Winch launches cause no difficulties at all allowed centre of gravity positions and wing loadings.

The plane has no tendency to balloon up or to swing on the ground. One should push forward slightly on the stick below about 100 metres (330 ft.) in the case of fast launches from a powerful winch. When the cable slackens pull the release firmly to its limit.

The undercarriage should not be retracted during a winch launch.

Aerotow

Trim lever should be in central position.

Maximum aerotow speed is 170 km/h (92 kts, 105 mph).

Aerotow should preferably use the nose hook.

The recommended length of tow rope is 40 — 60 m (120 — 200 ft.).

The glider can be controlled with coordinated rudder and aileron using full movements if required.

There is no tendency to swing in a strong crosswind.

The glider can be lifted off at about 70 km/h (38 kts, 44 mph).

The glider lifts off without assistance at a speed of about 80 km/h (43 kts, 50 mph) if the stick is kept in the neutral position.

The undercarriage can be retracted during aerotow at a reasonable height.

The yellow release handle is mounted on the instrument panel and must be pulled to its limit when releasing.

IV. 5 Free flight

It is possible to fly the glider over the entire speed range in all attitudes.

Full control movements are only allowed up to the manoeuvring speed 170 km/h (92 kts, 105 mph). At higher speeds the controls should be used with the appropriate care.

IV. 6 Slow flying and stalling

The glider gives clear warning when about to stall by a distinct shaking of the elevator.

The stalling speed depends on the wing loading and the condition of the plane. The following are guidelines:

Single seater

Weight	Without Airbrakes	With Airbrakes
470 kg = 1034 lbs	66 km/h (36 kts, 41 mph)	75 km/h (40,5 kts, 47 mph)

Double seater

Weight	Without Airbrakes	With Airbrakes
650 kg = 1430 lbs	80 km/h (43 kts, 50 mph)	90 km/h (49 kts, 46 mph)

If the stick is pulled back further the glider goes into a controllable high rate of sink, during which rudder and aileron turns can be flown at up to 15 degrees of bank. When the stick is released the glider returns to a normal flying attitude immediately.

After the stick is pulled back quickly the glider pitches nose down and the bank can still be controlled with aileron.

IV. 7 High speed flight

There is no tendency for flutter to develop within the permitted speed range. Above 170 km/h (92 kts, 105 mph) control movements should be restricted to 1/3 of full range. The airbrakes limit the speed to under VNE in a 45° dive even at maximum flying weight.

IV. 8 Cloud flying

The minimum instrumentation required for flying in cloud is:

Air speed indicator	Variometer	Turn and Slip
Altimeter	Compass	

Experience to date shows that the ASI does not get affected by icing.

If the manouvering speed is exceeded unintentionally, pull out the airbrakes to avoid overstressing.

In emergency open brakes and leave cloud at about 170 km/h (92 kts, 105 mph).

IV. 9 Simple Aerobatics

The glider is licenced for the following aerobatics (no waterballast):

1. Loop

Entry speed *	180 km/h (97 kts, 111 mph)
Maximum g	ca. 3 g
exit speed	ca. 180 km/h (97 kts, 111 mph)

2. Stall turn

Entry speed *	180 km/h (97 kts, 111 mph)
At 140 km/h (76 kts, 87 mph) slowly apply rudder.	
Shortly before the top apply opposite aileron.	

Note: The stall turn is difficult to carry out because of the high moment of inertia. If a tailslide is accidentally initiated during the climb lock all controls in the centre position.

3. Spin (possible in aft c.G. positions only)

Preparation. Decrease speed slowly to 80 km/h (43 kts, 50 mph) pull stick back and give full rudder. Glider spins slowly. Rotation rate is one turn every 3 seconds with a height loss of about 100 m (300 ft.) per turn.

Exit Rudder fully opposite against direction of turn, neutralise stick then pull out slowly after rotation has stopped.

4. Chandelle

Entry speed * 170 km/h (92 kts, 105 mph)

Pull up to fly 90° turn. During turn decrease speed and exit from turn with rudder and aileron. Chandelle should be completed heading in opposite direction.

* NB: For towseater configuration increase entry speed by 20 km/h (12 mph, 11 kts).

IV. 10 Approach and landing

Normal flying practice is to approach at 100 km/h = 54 kts. The airbrakes are sufficiently powerful for steep approaches. The use of brakes causes the glider to be slightly nose heavy, so that the glider holds the required speed by itself.

Avoid changing the airbrake setting during the roundout to avoid heavy landing.

IV. 11 Flight with waterballast

The water tanks are in the front of the wings and can hold about 50 l (11 gal.) per wing. The tanks are filled through the openings on the top of the wings. The cap can be removed with a pin. There is no noticeable water movement when the tanks are partially filled because of baffles installed within the tanks. There must always be equal amounts of water in each tank to avoid affecting the stability in roll.

The white lever on the right hand side of the cockpit should be pulled back to empty the tanks. The outlet is underneath the fuselage behind the wheel. It takes about 4 minutes to empty the tanks. It is strongly recommended that the tanks are emptied before landing out of field.

V. Rigging and derigging

V. 1 Rigging

The fuselage must be held firmly in a horizontal position when rigging. It is recommended to use a fuselage stand or the trailer fittings are used.

The glider can be rigged by 4 people.

1. Wings

Unlock the 4 main wing fittings in the fuselage. Unlock the air-brakes on the wings. Guide the right wing into the fuselage. The safety catches on the fuselage fittings should now be released, and on gently moving the wing to and fro will be heard to snap into place. Next guide the left wing into the fuselage. Move the wing tips up or down so that the pin on the end of the spar stub is lined up with the appropriate hole in the opposite wing root and slide into place. Next release the safety catches on the left hand fuselage fittings and by gently moving the wing to and fro they too can be made to snap into place.

Original wing-fuselage connection:

To secure the wing fittings the safety catches (1) have to be turned so that the pins (2) are pressed to the angled slots.

Moving the wing tip strongly to and fro enables the safety catches to be sufficiently turned (4). They should be hand tight and should not reach the end of the angled slot.

Wing-fuselage connection according to SB 315-58:

To secure the wing-fuselage connection in the closes position, the knurled nut (1) must be turned into the threaded socket (2) so that the socket is drawn against the red rings which are held by the guide pins (3). By means of moving the wing tips for and aft, the knurled nut can be secured tight (4) while securing the guide pins however, must not strike against the end of the milled selector of the shaft guide.

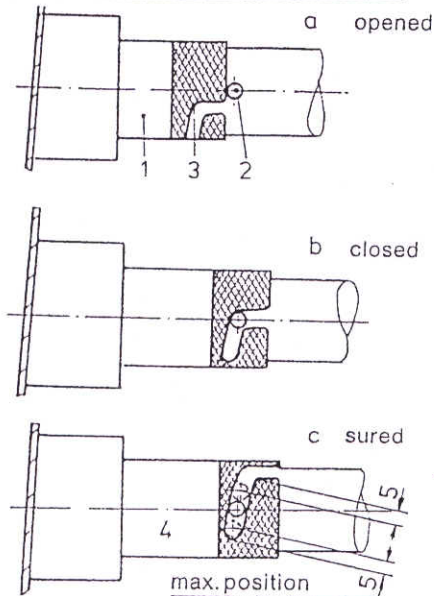
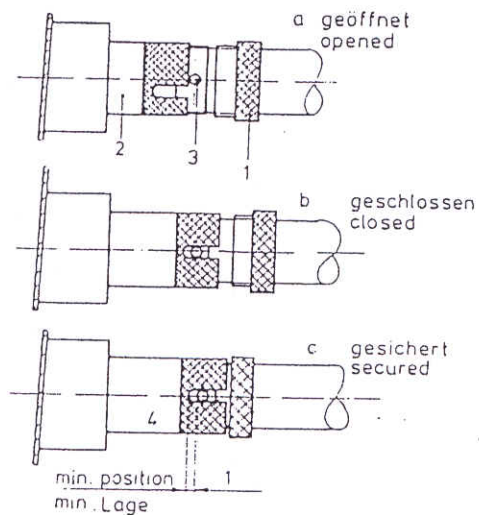
Original wing-fuselage connection:Wing-fuselage connection according to SB 315-58:

Check: The red rings at the fuselage connection rods must be covered by the threaded sockets, the socket (or the knurled nut acc. to SB 315-58) must be tightened hand tight.

In the closed, but not secured position (b), the wing bolt cannot be removed from the locking.

2. The aileron and brake connections lie behind the spar.

The short connecting rods in the fuselage are fitted with quick lock fasteners which must be coupled onto the balls on the linkages that move inside the wings.

After rigging the connections should be examined to check that the sprung catches are properly inserted so that they project some mm out of the locks.

Also after coupling the quick-lock fasteners, check that the ball can not be extracted by twisting the lock back and forth. Do this gently with not more than 10 lbs pull. Check all the control connecting rods and locks in a methodical order.

04.11.96

Rev. 7

3. Tailplane

Before assembly is commenced the front cover must be opened and the rotating wing bolt pulled out to the limit. The tailplane can be positioned by standing behind the rudder. The tailplane can be rested on top of the fin with the elevator angled upwards so that the snap lock fastener on the elevator push rod can be attached to the ball on the elevator horn. The front of the tailplane can then be lowered and pushed back onto the three pins. It is then necessary to tighten the wing bolt clockwise to secure the tailplane. The assembly is complete when the wing bolt is sufficiently tight that there is no play in any direction. The cover provides a safety measure as it can only be attached with the wing bolt horizontal. If necessary the wing bolt has to be turned a 1/4 turn to suit. Derigging is carried out in the opposite order and the wing bolt is turned anticlockwise and pulled fully out.

Checks to be made after assembly

1. Check that the 4 main wing fittings are locked.
2. Check that aileron and brake quick-actions locks are properly located on the knobs.
3. Ensure that the tow hook is functioning correctly.
4. Test the operation of the wheelbrake and the pressure of the air in the tire.
5. Check that the tailplane is securely seated and that the elevator push-rod is connected.
6. Rudder movement.

Derigging

Derigging is carried out in the opposite order and in this case it does not matter which wing is removed first. Excessive fore and aft rocking of the wing tips should be avoided.

V. 2 Storage

When the glider is stored the canopy should be locked. To tie down the wing, a rope can be pulled through the wing tip skids.

For ground handling the rotating tail wheel should be used.

V. 3 Transport

We recommend the use of a closed trailer for transporting the glider. The parts must be carefully supported and secured so they cannot slide.

1. Fuselage

A fuselage trolley moulded to the shape of the fuselage and positioned in front of the main wheel. The minimum length of the trolley should be 400 mm and it can be attached to the wing fittings if required. The tail skid should be secured so that it cannot slide sideways.

2. Wings

The minimum length for the spar support should be 200 mm and should start at the face of the root rib. The mounting must be padded well with foam rubber or felt.

The mounting under the aileron inboard end should be a shaped mounting block with a minimum length of 300 mm and height of 400 mm. The mounting must be padded with felt.

3. Tailplane

Either horizontal on padded supports with the upper surface downwards and secured with straps or vertical supported on the leading edge in shaped mounting blocks.

Profile drawings are available for the manufacture of fuselage, wing and tailplane fittings.

V. 4 Maintenance of the glider

The entire surface of the glider is coated with weather resistant white polyester gelcoat.

The greatest care should be taken in maintaining the fibre glass surface of the glider. Luke warm water should be used to wash off dust, grease, dead flies and other dirty marks. More resistant dirt should be removed by using a mild cleaning agent. Only special silicon-free preparations should be used in maintaining the painted surfaces. (1 Z-Spezialreiniger – D 2, Fa. W. Sauer and Co., 5060 Bensberg or Reinigungspolish Fa. Lesonal).

Although very resistant the glider should be protected as much as possible against rain and dampness. Water that has seeped in should be dealt with by storing the glider in a dry place, frequently turning over the dismantled parts.

The most effective way to clean the canopy is to use a special perspex cleaner but if necessary luke warm water can be used. A soft, clean cloth or chamois-leather should be employed to wipe the canopy down. Never rub perspex with anything dry.

The Safety harness should be regularly checked for damage and general wear. The metal parts of the harness should be frequently checked for corrosion.

Because of its position, the winch launch hook is susceptible to getting very grimy and muddy. It must therefore be frequently inspected for damage, cleaned and greased. When the seat-well is removed the hook can easily be taken out. Remove the connecting wire from the lever and take out the retaining screws. For reconditioning, the tow hook should be sent with the record card to the tow hook manufacturer, Tost. For further details the manufacturers manuals should be consulted.

The cables and pulley for the nose and belly hooks should be checked for wear during the yearly inspection. The main wheel tire pressure should be kept at 2.5 to 2.8 atmospheres (36-40 psi).

The wheelbrake is of a drum type (for S/N's 3000-3139 optional as a hydraulic disc brake).

Drum brake: The bowden cable can be adjusted. The adjustment is carried out by moving the Bowden cable at the drum end.

Disc brake: The main brake cylinder and the brake fluid reservoir are located under the rear seat. Use only brake fluid according to specification DOT3/ DOT4. During removing the main wheel for cleaning, greasing or changing the tire the Bowden cable must be disconnected from the brake lever (drum brake) or the brake cylinder must be removed (disc brake). Do not open the brake fluid hose.

Screw the M 6 threaded special tool onto one side of the axle and take out the screws and the spindle. Remove the screws that hold the brake-lever in place. Take the wheel out by pulling it downwards. Clean all the parts and before re-assembly smear all of them with grease.

Before assembling the glider the pins and sockets at the joints between wings and fuselage, and tailplane and fuselage, should be cleaned and greased.

28.09.92
TM 315-50

VI. Appendices

VI. 1 Flight Performance

Flying weight	470 (1036)	560 (1234)	650 (1435)	kg (lbs)
Wing loading	26.4 (5.4)	31.5 (6.5)	36.5 (7.5)	kg/m ² (lbs/ft. ²)
Best glide Angle	37.0	37.5	38.0	
at a speed of	95 (51)	105 (57)	110 (60)	km/hr (kts)
Minimum sink	0.62 (2.03)	0.68 (2.23)	0.73 (2.3)	m/sec (ft./sec)
at a speed of	75 (40)	80 (43)	90 (49)	km/hr (kts)

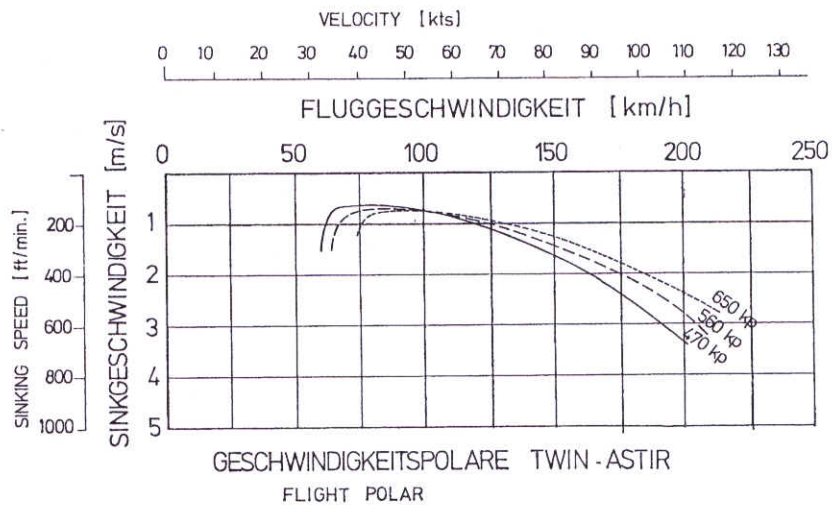

VI. 2 Service and Maintenance instructions

Regular service.

The following schedule of service should be carried out every 100 hours or at the annual inspection, which occurs first.

1. The entire glider should be checked for cracks, holes and bumps.
2. All fittings should be inspected for satisfactory condition (play, scores and corrosion).
3. All metal parts should be examined for corrosion, cracks, deformation and if necessary reconditioned and freshly protected.
4. Check that there is no play in the wing and tailplane to fuselage fittings.
5. The control linkages (Bearings, stops, fittings, hinges and control cables) should be inspected and replaced if there is evidence of bending or corrosion.
6. The controls including the brakes should be submitted to a functional test and the control deflections checked.
7. If the controls do not move free throughout their range, search for the cause and correct.
8. The undercarriage should be inspected and the wheel and brake checked to be in good condition.
9. The tow hooks should be treated in accordance with their appropriate maintenance manual.
10. Check the pitot for the ASI is clear and that the tubing to all instruments is in good condition and free of leaks or kinks.
11. The condition and calibration of all instruments should be checked and any other equipment inspected.
12. Equipment and instruments should be checked against the equipment list.
13. Check markings and placards.
14. After repair or change of equipment, the weight table should be updated with the new empty weight and Center of Gravity by weighing or calculation.

After extended storage check accordingly to regular service pos. 1 to 11 and inspect for evidence of rodents and birdness.

VI. 3 Reference to Repairs

The attached repair instructions give information for the execution of minor repairs.

Major repairs, in accordance with the glider information sheet are only permitted to be carried out by an authorised aircraft works. Grob will name a company with the appropriate qualifications in any individual case.

VI. 4 Installation, maintenance and examination of the release hooks

One is bound by the Maintenance Manuals for the nose hooks 'E 72' and 'E 75' published in May 1975 and the Maintenance Manual for the belly hooks 'Europa G 72' and 'Europa G 73' published in May 1975.

VI. 5 Determination of the Center of Gravity

The determination of the center of gravity is made with the undercarriage lowered and the glider supported on two scales at heights such that an incidence board of 600 : 24 angle is set horizontal on the back of the fuselage.

The reference plane lies at the front of the wing at the root. The distances a and b are measured with the help of a plumb line. The empty weight is the sum of the two weights G_1 and G_2 .

Procedure for determining C. of G. empty

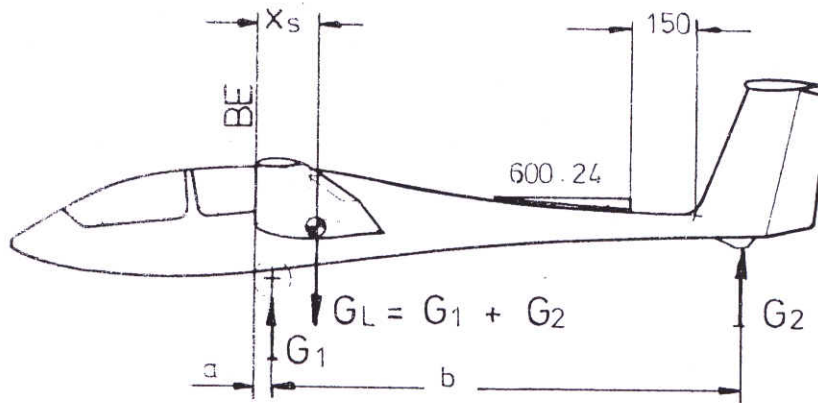

Datum Line: Front edge of the wing at the root

Level Means. With a 600:24 Incidence Board set up horizontal on the top of the rear fuselage.

- Weight on main-wheel $G_1 =$ kg / lbs
- Weight on tail-skid $G_2 =$ kg / lbs
- Empty Weight $G_L = G_1 + G_2 =$ kg / lbs
- Distance to main-wheel $a =$ mm / inches
- Distance to tail-skid $b =$ mm / inches

Empty Weight C. of G.

$$x = \frac{G_2 \times b}{G_L} + a = \text{---} = \text{mm/inches behind Datum Line}$$

The measurements to determine the empty weight, the empty weight C. of G. and the loading limitations must always be taken with the glider empty of waterballast.

	from	to	multiply with
Conversion:	kg	lbs	2.2
	mm	inches	0.0394

If the limits of the empty weight C. of G. positions and the loading limitations chart are adhered to the C. of G. of the loaded glider will be within the permitted range.

Empty Weight		Range of C. of G. behind Datum			
kg	lbs	Forward		Aft	
		mm	inches	mm	inches
390	860	725	28.54	747	29.41
395	871	719	28.31	744	29.29
400	882	713	28.07	740	29.13
405	893	708	27.87	737	29.02
410	904	702	27.64	733	28.86
415	915	697	27.44	730	28.74
420	926	692	27.24	727	28.62
425	937	687	27.05	724	28.50
430	948	682	26.85	720	28.35

It should be noted that to make use of the maximum load the maximum admissible load for non-lifting parts must not be exceeded.

The weight of the non-lifting parts is the sum of the fuselage, tailplane and maximum load in the fuselage and must not exceed 470 kgs (1036 lbs) or the maximum load permitted in the fuselage must be correspondingly decreased.

The Centre of Gravity should be recalculated after repair, repainting, the installation of additional equipment or when a period of 4 years has elapsed after the last weighing.

The empty weight, empty weight C. of G. position and maximum load, should be recorded after each weighing on page 9 of the Flight Handbook.



GROB FLUGZEUGBAU
8939 Mattsies
Flugplatz Mindelheim-Mattsies
Telefon 0 82 68 / 4 11

Maintenance Handbook

This handbook must be carried on board at all times.

It refers to the TWIN ASTIR Sailplane.

Registration:

Factory Serial Number:

Owner:



German edition of operating instructions are approved under § 12/2.
of LuftGerPO.

Published May 1978

Approval of translation has been done by best knowledge and judgement — In any case the
original text in German language is authoritative.

Index	page
Updates	2
I. Technical Data	3
II. Description of components	5
II. 1 Control Linkages	5
II. 2 Installation of Radio	11
II. 3 Installation of Oxygen	11
II. 4 Pressure tubing and connections to the instruments	12
III. Rigging Data and specifications	13
IV. Determination of the center of gravity	14
V. Weight and Moments of Inertia of the control surfaces	16
VI. Checks	17
VII. Regular Service	18
VIII. Lubrication	19
IX. Labels and Markings	20
X. General care	22
XI. Inspection procedure for increase of service time	23

Updates:

Rev.No.	Page	Reference	Date	Signature	LBA - approval
1	19a	TRAINER undercarriage	01.10.78		
2	2, 19	Maintenance of Hotellier-quick-connectors	04.05.81		
3	1, 2, 23	Inspection procedure for increase of service time	30.09.81		
4	2, 16, 22, 23	Extension of service life	11.10.91		
5	2, 21	Envelope limitations ASB315-64	30.06.2003		
6	2, 21	MSB 315-64/3 Revised Limits of Operation	14.09.2004		2. OKT. 2004 

14. September 2004