

AFMS D-2080

Airplane Flight Manual Supplement

- Radio Becker 6201
- ACL Anti-collision light
- Flarm
- LX8080

VHF-Transceiver Family

AR620X-(X1X)

AR620X-(X2X)

RT6201-(X10)

RT6201-(X20)

RCU6201-(X12)

Software Versions:

upwards from Software Version

SCI1050S305 Version 4.06

SCI1051S305 Version 2.06

Installation and Operation

Manual DV14307.03

Issue 05 September 2016

Article-No. 0638.404-071

Preface

Dear Customer,

Thank you for purchasing Becker Avionics products.

We are pleased that you have chosen our product and we are confident that it will meet your expectations.

For development of our product, the guidelines for highest quality and reliability have been borne in mind, supplemented by selection of high quality material, responsible production and testing in accordance to the ISO 9001 and DIN EN 9100 standards.

Our competent customer support department will respond on any technical question you may have.

Please do not hesitate to contact us at any time.

VHF-Transceiver Family



AR6201 (Single Block Transceiver)

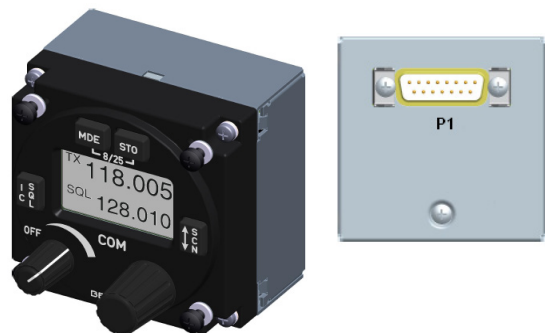

RCU6201 (Remote Control Unit)



AR6203 (Single Block Transceiver)

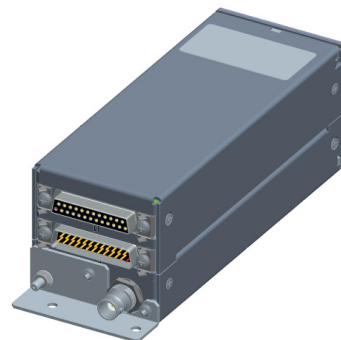

RT6201 (Remote Transceiver)

List of Effective Pages and Changes

Only technical relevant modifications are described in this table.

Document:		DV14307.03 / issue 05	Article Number 0638.404-071
Cover Page		09/2016	
Introduction		09/2016	
Chapter 1 – 4		09/2016	
Issue	Page No.:	Section / Chapter	Description
05	1...118	all	Changed: Editorial adjustments.
	--	1.5	Updated: Product descriptions.
	--	1.9.10.1	Added: Description "FCC Approval"
	--	1.9.10	Updated: Certifications
	--	2.3	Updated: Mounting descriptions.
	--	2.9	Updated: Wiring diagrams
	--		
	--		
	--		
	--		
	--		
	--		
	--		
	--		
	--		
	--		

© 2016 by Becker Avionics GmbH / all rights reserved

Table of Contents

1. General Description.....	11
1.1. Introduction.....	12
1.2. Purpose of Equipment.....	13
1.3. General Notes.....	13
1.4. Variants Overview.....	14
1.4.1. Software Status.....	15
1.5. Short Description.....	16
1.5.1. AR6201 Single Block Transceiver.....	17
1.5.2. AR6203 Single Block Transceiver.....	17
1.5.3. RT6201 Remote Transceiver.....	18
1.5.4. RCU6201 Remote Control Unit.....	18
1.6. Features Overview.....	19
1.7. Safety-Conscious Utilization.....	21
1.8. Restriction for Use.....	21
1.9. Technical Data.....	22
1.9.1. Receiver Data for AR620X and RT6201.....	23
1.9.2. Transmitter Data AR620X and RT6201.....	24
1.9.3. Dimensions & Weight.....	24
1.9.4. Emergency Operation.....	25
1.9.5. Software.....	25
1.9.6. Hardware.....	25
1.9.7. Continued Airworthiness.....	25
1.9.8. Environmental Qualification AR620X and RCU6201.....	26
1.9.9. Environmental Qualification RT6201.....	27
1.9.10. Certifications.....	29
1.9.10.1. FCC Approval.....	30
1.10. Order Code.....	31
1.10.1. 620X.....	31
1.10.2. Accessories.....	31
2. Installation.....	33
2.1. Packaging, Transport, Storage.....	33
2.2. Device Assignment.....	34
2.2.1. Scope of Delivery.....	34
2.2.2. Additional Required Equipment.....	34
2.2.3. Type Plate.....	35
2.2.4. Software/Firmware Status – Functionality.....	35
2.3. Mechanical Installation.....	36
2.3.1. Mounting Requirements.....	36
2.3.2. AR6201 and RCU6201 Installation (Back Panel Mounting).....	37
2.3.3. AR6203 Installation.....	39
2.3.4. RT6201 Installation.....	41
2.4. Electrical Interface.....	44
2.4.1. Connector and Pin Assignment - AR620X and RT6201.....	44
2.4.1.1. Inputs / Outputs.....	47
2.4.2. Connector and Pin Assignment - RCU6201.....	51
2.5. Installation and Configuration.....	53
2.6. Antenna Installation.....	53
2.7. Configuration Setup.....	54
2.7.1. Start Configuration Setup.....	54
2.7.2. Navigate between Pages.....	54
2.7.3. Store Setup Data.....	55
2.7.4. Leave Configuration Setup.....	55
2.7.5. Adjust Volume Settings (VU Meter).....	55
2.7.6. Configuration Setup Pages - Description.....	56
2.8. Factory Default Settings.....	69
2.9. Aircraft Wiring and Settings.....	71
2.9.1. Single Seat Glider.....	71
2.9.1.1. Configuration Setup.....	71
2.9.1.2. Wiring Diagrams Single Seat Glider.....	72

2.9.1.3.	Wiring Diagrams Single Seat Glider 5-pol DIN Jack.....	73
2.9.2.	Twin Seat Motor Glider	74
2.9.2.1.	Configuration Setup.....	74
2.9.2.2.	Wiring Diagram Twin Seat Motor Glider.....	75
2.9.3.	General Aviation (GA) Aircraft	76
2.9.3.1.	Configuration Setup (using Standard Microphones).....	76
2.9.3.2.	Wiring Diagram General Aviation GA Using Standard Microphones.....	77
2.9.4.	Individual Dual Headset Configuration (two IC Circuit)	78
2.9.4.1.	Configuration Setup.....	78
2.9.4.2.	Wiring Diagram Individual Dual Headset Configuration - two IC Circuit.....	79
2.9.5.	Twin Seat with AR620X Tandem Configuration	80
2.9.5.1.	Configuration Setup.....	80
2.9.5.2.	Wiring Diagram Twin Seat with AR620X Tandem Configuration.....	81
2.9.6.	Aircraft with four Seats (no TANDEM).....	82
2.9.6.1.	Configuration Setup.....	82
2.9.6.2.	Wiring Diagram Aircraft with four Seats - no TANDEM.....	83
2.9.7.	Installation RT6201 and RCU6201	84
2.9.7.1.	Wiring Diagram with RT6201 and RCU6201	84
2.9.8.	Aircraft with Intercom System	85
2.9.8.1.	Configuration Setup.....	85
2.9.8.2.	Wiring Diagram Aircraft with Intercom System Unbalanced	86
2.9.8.3.	Wiring Diagram Aircraft with Intercom System Balanced	87
2.9.9.	Twin Seat with RT6201 Tandem Configuration.....	88
2.9.9.1.	Configuration Setup.....	88
2.9.9.2.	Wiring Diagram Twin Seat with RT6201 Tandem Configuration	89
2.10.	Predesigned Cable Harness	90
2.10.1.	1K065 for General Aviation.....	90
2.10.2.	1K062 (Open Cable Ends).....	90
2.11.	Retrofitting AR4201 with AR6201	90
2.11.1.	Pin Compatibility AR4201 - AR6201	91
2.11.2.	Dynamic Microphone Input.....	92
2.11.3.	Temperature Sensor.....	92
2.11.4.	RS232 Interface	92
2.11.5.	AFCU/AGC/AFWB.....	92
2.11.6.	CPIN (if Installed).....	92
2.11.7.	+13.75 V Switched (AR4201) - PWR_EVAL (AR6201).....	93
2.12.	Post Installation Tests	93
2.12.1.	Mechanical Installation and Wiring Check	93
2.12.2.	Power Supply.....	93
2.12.3.	Receiver / Transmitter Operation.....	93
2.12.4.	Antenna Check	93
2.12.5.	Interference Check.....	94
2.12.6.	Flight Test Check.....	95
2.13.	Trouble Shooting.....	96
2.14.	Continued Airworthiness	97
3.	Operating Instructions	99
3.1.	Device Description	100
3.1.1.	Device Assignment	100
3.1.2.	Packing, Transport, Storage	100
3.1.3.	Scope of Delivery.....	100
3.1.4.	Type Plate.....	100
3.2.	Controls and Indicators	101
3.3.	Start-Up.....	102
3.4.	Receive and Transmit Mode	102
3.4.1.	Receive Mode.....	102
3.4.2.	Transmit Mode	102
3.5.	Frequency Selection Modes.....	103
3.5.1.	Standard Mode	103
3.5.2.	Direct Tune Mode	104
3.5.3.	Channel Mode.....	106
3.5.3.1.	Select Channels	106

Introduction

3.5.4. Frequency Storage Functions	107
3.5.4.1. Store	107
3.5.5. Automatic Storage Function	108
3.5.5.1. Delete data:	108
3.5.6. Scan Mode	109
3.6. SQUELCH	110
3.7. RX Field Strength Indication	110
3.8. Channel Spacing Mode	110
3.9. Auxiliary Audio Input	111
3.10. Intercom Operation	111
3.11. VOX & Speaker Operation	112
3.12. Menus	113
3.12.1. Intercom Menu	113
3.12.2. User Menu	114
3.13. Warning and Failure Indications	116
4. Index.....	118

Figure 1-1: AR6201 Single Block Transceiver.....	17
Figure 1-2: AR6203 Single Block Transceiver.....	17
Figure 1-3: RT6201 Remote Transceiver	18
Figure 1-4: RCU6201 Remote Control Unit.....	18
Figure 2-1: Type plate (example)	35
Figure 2-2: Dimensions AR6201, RCU6201 (front view).....	37
Figure 2-3: Drilling template (back panel mounting).....	37
Figure 2-4: Dimensions RCU6201 (side view)	37
Figure 2-5: Dimensions AR6201 (top-, side view)	38
Figure 2-6: Dimensions AR6203 top view, side view	39
Figure 2-7: Dimensions Mounting kit MK6403-1 (for AR6203).....	40
Figure 2-8: Dimensions RT6201 (top-, side view)	41
Figure 2-9: Dimensions Mounting kit MK6201-(010)	42
Figure 2-10: RT6201 fixed on MK6201-(010) (top view)	42
Figure 2-11: RT6201 front view	43
Figure 2-12: MK6201-(010) mounting kit.....	43
Figure 2-13: Dimensions RT6201 with mounting kit MK6201.....	43
Figure 2-14: Connectors AR6201, RT6201	44
Figure 2-15: Connectors AR6203.....	44
Figure 2-16: Connectors RCU6201	51
Figure 2-17: "PASSWORD DIALOG"	54
Figure 2-18: "DECIVE INFO"	54
Figure 2-19: Wiring for Single Seat Glider.....	72
Figure 2-20: Wiring for Single Seat Glider (5-pol DIN Jack).....	73
Figure 2-21: Wiring for Twin Seat Motor Glider.....	75
Figure 2-22: Wiring for Usage of Standard Hand Mikes, Earphones and Speaker	77
Figure 2-23: Dual wiring for Usage of Standard Hand Mikes, Earphones and Speaker.....	79
Figure 2-24: Wiring for Twin Seat with AR620X Tandem Configuration.....	81
Figure 2-25: Wiring for Aircraft with Four Seats (no TANDEM).....	83
Figure 2-26: Wiring for RT6201 with RCU6201 as Primary Controller	84
Figure 2-27: Wiring for Aircraft with Intercom System (unbalanced)	86
Figure 2-28: Wiring for Aircraft with Intercom System (balanced)	87
Figure 2-29: Wiring for Twin Seat with RT6201 Tandem Configuration	89
Figure 2-30: Cable Harness 1K065	90
Figure 2-31: AR6201 with Wiring Interface for AR4201.....	92
Figure 2-32: Modified Dynamic Microphone Wiring Interface for AR6201.....	92
Figure 3-1: Controls and Indicators	101

List of Abbreviations

List of Abbreviations

AF	Audio Frequency
AR	Airborne Radio
ATT	Attenuation
AUX	Auxiliary
AWG	American Wire Gauge
BNC	Bayonet Neill Concelman
CBIT	Continuous Built-In Test
CFG	Configuration
CH	Channel
CM	Control Head , Core Module
COM	Communication
EASA	European Aviation Safety Agency
EMI	Electro Magnetic Interference
ETSO	European Technical Standard Order
EUROCAE	European Organisation for Civil Aviation Equipment
FAA	Federal Aviation Administration
GND	Ground (Aircraft Ground)
GPS	Global Positioning System
HIRF	High Intensity Radiated Fields
HMI	Human Machine Interface
I&O	Installation & Operation
IC	Intercom
LCD	Liquid Crystal Display
M&R	Maintenance & Repair
MFD	Multi-Function Display
N/A	Not Applicable
NAV	Navigation
PBIT	Power-On Built In Test
PTT	Push To Talk
PWR	Power
RCU	Remote Control Unit
RSSI	Received Signal Strength Indication
RT	Remote Transceiver
RX	Receive
SPKR	Speaker (Loudspeaker)
SQL	Squelch
SRC	Source
SW	Software
TSO	Technical Standard Order
TX	Transmit
VDC	Voltage Direct Current

List of Abbreviations

VHF	Very High Frequency
VOX	Voice Operated IC Threshold
VSWR	Voltage Standing Wave Ratio
VU	Volume Unit

Units

Units

V	Volt
mV	Millivolt
A	Ampere
mA	Milliampere
W	Watt
mW	Milliwatt
kHz	Kilohertz
MHz	Megahertz
s	Second
dBm	Power ratio in Decibel
dB	Decibel
Ohm (Ω)	Resistor
kg	Kilogram
°C	Degree Celsius
mm	Millimetre
cm	Centimetre

General Safety Definitions



DANGER Indicates a hazardous situation which, if not avoided, will result in death or serious injury.



WARNING Indicates a hazardous situation which, if not avoided, could result in death or serious injury.



CAUTION Indicates a hazardous situation which, if not avoided, could result in minor or moderate injury.

NOTICE

Is used to address practices not related to physical injury.

SAFETY INSTRUCTIONS

Safety instructions (or equivalent) signs indicate specific safety-related instructions or procedures.

3. Operating Instructions

In this chapter you can read about:

3.1. Device Description	100
3.1.1. Device Assignment	100
3.1.2. Packing, Transport, Storage	100
3.1.3. Scope of Delivery	100
3.1.4. Type Plate	100
3.2. Controls and Indicators	101
3.3. Start-Up	102
3.4. Receive and Transmit Mode	102
3.4.1. Receive Mode	102
3.4.2. Transmit Mode	102
3.5. Frequency Selection Modes	103
3.5.1. Standard Mode	103
3.5.2. Direct Tune Mode	104
3.5.3. Channel Mode	106
3.5.4. Frequency Storage Functions	107
3.5.5. Automatic Storage Function	108
3.5.6. Scan Mode	109
3.6. SQUELCH	110
3.7. RX Field Strength Indication	110
3.8. Channel Spacing Mode	110
3.9. Auxiliary Audio Input	111
3.10. Intercom Operation	111
3.11. VOX & Speaker Operation	112
3.12. Menus	113
3.12.1. Intercom Menu	113
3.12.2. User Menu	114
3.13. Warning and Failure Indications	116

This chapter contains general information and instructions to ensure safe operation of the VHF transceivers.

3.1. Device Description

NOTICE

In this section the figures for illustrating display content mainly show transceivers working in 8.33/25 kHz mixed mode. Dedicated pictures for 25 kHz mode are not explicitly shown (they differ only in number of digits for frequency).

The HMI actions described in this section can be performed on primary controller or on optional secondary controller RCU6201.

The following graphics of the display content show the 8.33 kHz channel spacing for all possible operation modes.

3.1.1. Device Assignment

This manual is valid for the following devices:

- See page 34

3.1.2. Packing, Transport, Storage

- See page 33

3.1.3. Scope of Delivery

- See page 34

3.1.4. Type Plate

- See page 35

NOTICE

Switch OFF the device before starting or shutting down engines.

SAFETY INSTRUCTIONS

A voice communication test shall be performed before starting the engine.

It should be noted that, if the communication test is carried out close to a ground station, the results may be positive even if the antenna cable is broken or short-circuited. In such a case, at a distance of 5 to 10 km and above, communication might not be possible.

- Speak always loud, clear and not too fast for optimal voice communication.
- Keep the microphone always close to the lips otherwise a special suppressing circuit in the VHF COM will not be capable to suppress normal cabin noise.
- Use only microphones or headsets which are suitable for use in an aircraft.
 - In aircraft made of wood, synthetic materials or in gliders or helicopters, incoming radiation can affect the integrated amplifier of the microphone (feedback), noticeable in the ground station by whistling and/or heavy distortion.

If the power supply voltage drops below the "Low Battery Threshold" (default value is 10.5 V), the "LOW BATTERY" message will appear each 3 seconds in the lower part of the display.

SAFETY INSTRUCTIONS

If the power supply voltage drops below 10 V the system enters power saving mode:

- Speaker output of the transceiver is automatically switched "OFF"
- Speaker sign will no longer be presented on LCD display
- The pilot must use headphones to continue listening.

3.2. Controls and Indicators

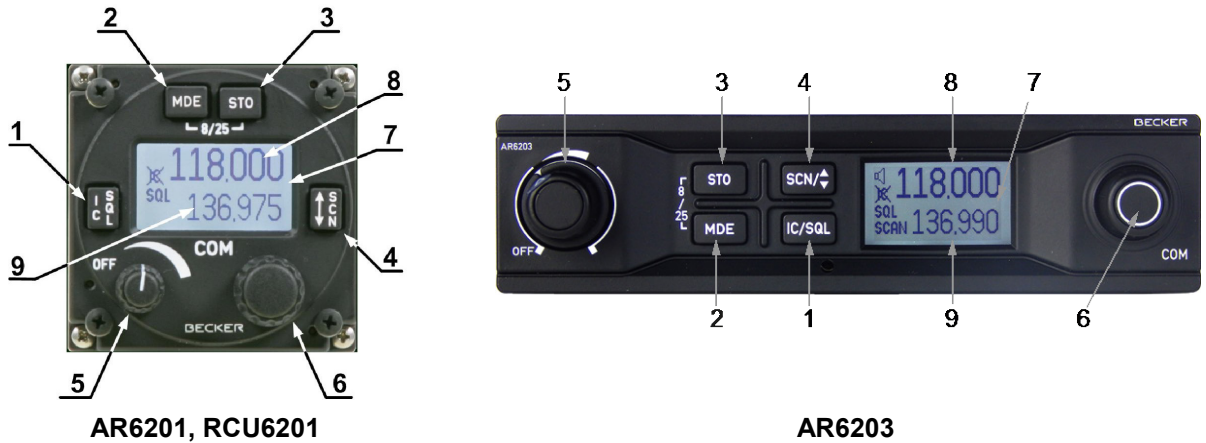

Figure 3-1: Controls and Indicators

	Symbol	Description	Main Function
1		IC/SQL (Intercom/Squelch)	"Short press" during normal operation toggles the RX -SQL ON/OFF. "Long press" during normal operation activates Intercom Menu.
2		MDE (Mode)	"Short press" during normal operation changes the frequency selection mode. "Long press" during normal operation activates the user menu.
3		STO (Store)	"Short press" during normal operation activates storage procedure.
4		↑/SCN (Exchange/SCAN)	"Short press" during standard mode, or scan mode toggles between preset and active frequency. "Long press" activates scan mode.
5		Power ON/OFF, Volume Knob	Switches the transceiver ON/OFF and adjusts volume level of received signal.
6		Rotary encoder	Turning "ROTARY ENCODER" changes the settings of several parameters (frequency, IC-volume, VOX, ...). Pushing the "ROTARY ENCODER" toggles between the digits and acts as an enter key.
	-8/25-	Change of Channel Spacing	Keeping the MOD and STO button pressed simultaneously longer than 2 seconds changes 8.33 to 25 kHz channel spacing and vice versa.
7		Display	LCD: Liquid Crystal Display
8		Active frequency	Only on the active frequency, transmitting is possible and receiving has priority, even in scan mode. Frequency tuning is not possible in standard mode.
9		Preset frequency	Frequency tuning is possible in standard mode. In scan mode both frequencies, active and preset are in listening watch. If no receive signal is detected on the active frequency, receiving signals on the preset frequency will be audible, but will be muted as soon as a signal on the active frequency is detected.



The device detects a:

"Long press": when pressing and holding down a key for at least 2 seconds.

"Short press": any pressing below 2 seconds.

If any action by the user is invalid, the whole display inverting for a short time.

Symbols shown on the Display

Symbol	Function
IC	Intercom operation is active (triggered by VOX or external IC key)
	Intercom operation via VOX is disabled
TX	The transceiver is in transmit operation
SQL	The squelch function is active, weak RX signals suppressed.
SCAN	Transceiver operates in scan mode
STO	The transceiver performs a storage operation.
LOW BATT	Battery below predefined low threshold
128.225	Inverted figures or letters on display ready to edit
	Speaker on

3.3. Start-Up

SAFETY INSTRUCTIONS

Excessive pulses on the DC bus of the aircraft may cause damage on electrical circuits of any installed instrument.

Do not switch ON the device during engine start or shutdown

- Turn "ON" the device by turning the volume knob clockwise.
- During PBIT (Power-On Built In Test) the display indicates the message "WAIT", the software version of "Control Head" (CH) and the software version of "Core Module" (CM).
- If the PBIT has detected error(s), "FAILURE" appears on the display (for details see chapter 3.13).

3.4. Receive and Transmit Mode

3.4.1. Receive Mode

If /PTT1 and /PTT2 (Push To Talk) inputs are inactive, the transceiver remains in receive mode.

In receive mode the headphone(s) outputs (if enabled) provide a mixed signal consisting of:

- Received signal from antenna,
- Intercom signal from intercom circuit one and two,
- Signal from auxiliary input.

In receive mode the speaker output (if enabled) provides a mixed signal consisting of:

- Received signal from antenna
- Signal from auxiliary input

The signal from the auxiliary input been muted under certain conditions (For details refer to "Intercom Operation", page 111).

The signal from intercom can be attenuated, or muted, under certain conditions (For details refer to "VOX & Speaker Operation", page 112).

3.4.2. Transmit Mode

If /PTT input is active (PTT=Push To Talk key is pressed) the transceiver switches to transmit mode. Microphone(s) signals can modulate the transmitter.

- PTT 1 input activates transmission from microphone path 1
- PTT 2 input activates transmission from microphone path 2
- If BOTH MIKES are active / enabled in the configuration setup, each input (PTT 1 or 2) activates the transmission from both microphone paths simultaneously.

The "TX" symbol in the left upper corner of the display indicates the device is in transmit mode.

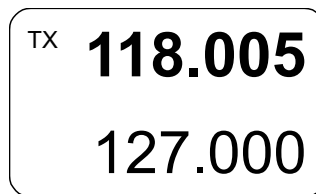

In transmit mode several user actions such as changing frequency selection mode or channel spacing mode, which are normally allowed in receive mode, are blocked. (As an exception in standard mode the "Preset" frequency may still be changeable, even during transmission).

No intercom operation is possible in transmit mode.

The sidetone (demodulated audio of the emitted signal) is available on the headphone output. The transmit mode automatically deactivates the speaker.

Note: Transmit mode is automatically terminated (return to receive mode) after 120 seconds of continuous transmitting even if PTT is still pressed. In this case "STUCK PTT" is indicated (refer to page 116). For initiation of a new transmission, /PTT line needs first to become inactive.

3.5. Frequency Selection Modes

Following frequency selection modes are available on AR620X and RCU6201:

- Standard mode
- Direct tune mode
- Channel mode
- Scan mode

The "Standard Mode", "Direct Tune Mode" and "Channel Mode" provide different user interfaces for convenient selection of the operating frequency. These three frequency selection modes are selectable by consecutive short pressing of "MDE" key. They appear in the following order: "Standard Mode", "Direct Tune Mode" "Channel Mode", "Standard Mode", and so on. When toggling between the three modes the active frequency always remains the same and active.

"SCAN Mode" is a sub-mode of standard mode and used for monitoring two frequencies at the same time. A 2 seconds press on "↓/SCN" key activates/deactivates the scan function.

The availability of the modes depends on enabling or disabling in the "Configuration Settings".

3.5.1. Standard Mode

Press the "MDE" key until the standard mode page appears.

The standard mode page displays the active frequency in the top line and preset frequency in the bottom line.



Changing the active frequency is not possible in standard mode (only available in direct tune mode) but changing the preset frequency is possible.

Changing the preset frequency in standard mode:

- Make a "short press" on the "ROTARY ENCODER" for modification of the 100 MHz digits. Rotate the "ROTARY ENCODER" clockwise/counter clockwise to change the frequency in 1 MHz steps.

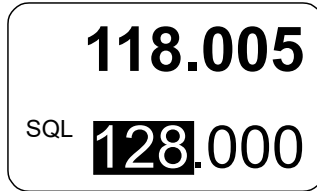

- Make another "short press" on the "ROTARY ENCODER" for modification of the 100 kHz digits. Rotate the "ROTARY ENCODER" clockwise/counter clockwise to change the frequency in 100 kHz steps.

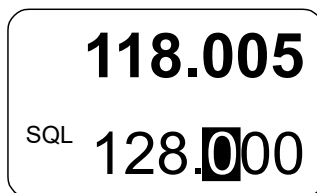

- Make another "short press" on the "ROTARY ENCODER" for modification of the 25/8.33 kHz digits. Rotate the "ROTARY ENCODER" clockwise/counter clockwise to change the frequency in 25/8.33 kHz steps.

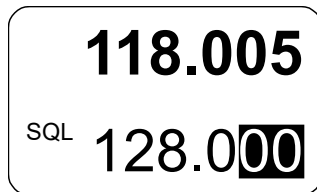

A short press of the "↕/SCN" key, exchanges active frequency to preset frequency and vice versa. If wanted, please press now the "STO" key to store the active frequency into the next vacant memory place of the user channels database.

Note: While the transceiver operates in transmit mode, the toggle function is disabled.

3.5.2. Direct Tune Mode

Press the "MDE" key until the direct tune mode page appears.

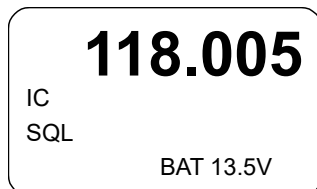

Note: The battery information is only displayed if BATTERY VOLTAGE in the configuration setup is selected.

In direct tune mode, the active frequency appears in the top line. It can be edited by means of the "ROTARY ENCODER" following the procedure.

Changing the active frequency when in direct tune mode:

- Make a "short press" on the "ROTARY ENCODER" for modification of the 100 MHz digits. Rotate the "ROTARY ENCODER" clockwise/counter clockwise to change the frequency in 1 MHz steps.



- Make another "short press" on the "ROTARY ENCODER" for modification of the 100 kHz digits. Rotate the "ROTARY ENCODER" clockwise/counter clockwise to change the frequency in 100 kHz steps.

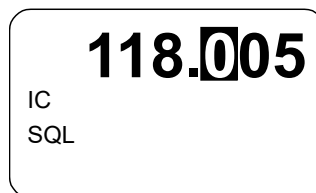

- Make another "short press" on the "ROTARY ENCODER" for modification of the 25/8.33 kHz digits. Rotate the "ROTARY ENCODER" clockwise/counter clockwise to change the frequency in 25/8.33 kHz steps.

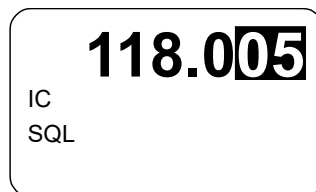

Notes:

The changes become active immediately

Changing the active frequency is possible only when the transceiver is not transmitting.

If wanted, please press now the "STO" key to store the active frequency into the next vacant memory place of the user channels database.

3.5.3. Channel Mode

The channel mode shows data from User Channels Database (indicated by "CH"), or Last Channels Database (indicated by "LAST") and shows if applied a customized label (identifier) for the frequency (max. 10 characters).

The channel database provides storage of:

- CH01 to CH99 and
- LAST 1 to LAST 9.

Note **The functions "LAST" and Store/Restore are only available if this options are activated in "Configuration Settings" - "MEM OPTIONS".**

Note: **If the device is operating in the 25 kHz mode a selection of an earlier stored 8.33 kHz channel is not possible. For selection of 8.33 kHz channels, the device must operate in 8.33 + 25 kHz mixed mode.**

Press the "MDE" key the channel mode page appears.

By means of channel number stored frequencies can be selected. The top line shows the corresponding frequency and the bottom line the customized label (identifier) assigned to the frequency number.

If the active frequency has no assigned channel number the indication is "CH--".

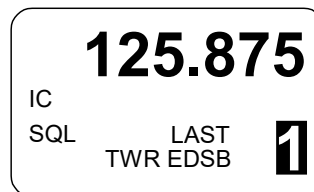
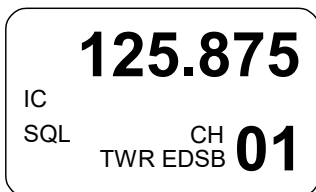

3.5.3.1. Select Channels

Example: **With CH01 user channel shown on display:**

In order to select the channel number:

- The first turn clockwise in channel mode provides navigation up user channels CH01 to CH99.
 - Make a short press of the "ROTARY ENCODER", or:
 - Make one clockwise turn of the "ROTARY ENCODER".

The channel number is now highlighted and the channel can be changed turning the "ROTARY ENCODER". At each step the receiver tunes immediately to the displayed frequency.

- The first turn counter-clockwise will enter to the channel "LAST 1".
 - The channel number is now highlighted and one of the nine last used channels is selectable by turning the "ROTARY ENCODER" either counter clockwise or clockwise.

The "LAST" mode is left automatically after a 5 second timeout or can be deselected by repeated pressing of the "ROTARY ENCODER".

When leaving the "LAST" channel database and the last shown frequency is not stored in the User channel database, "CH__" appear on the display. Press "STO" to start the storage process.

Leave Channel Mode:

Press the "MDE" key the standard page appears.

3.5.4. Frequency Storage Functions

Start store function by pressing:

- "STO" key in "Standard Mode", "Direct Tune Mode" and "SCAN Mode".
 During this procedure, the display looks similar to the channel mode with one difference that "STO" appears on the left side of the display.

3.5.4.1. Store

The transceiver provides two databases:

- User channels database - provides 99 channels CH01 to CH99 to store frequencies with the possibility to apply a customized label (identifier) with max. 10 alphanumeric characters.
- Last channels database - automatically stores 9 last used frequencies with customized identifier if applied, easy to recall as LAST 1 to LAST 9.
- Any frequency can be assigned to any channel within the range from 118.000...136.9916 MHz by simply pressing the "STO" button.
- All 99 channels are editable.

By entering the storage procedure, the device will first propose the next free channel for storing the active frequency.

- The label "FREE" appears together with the channel number, if the selected channel is vacant.
- A selected channel with an already stored frequency, has the label "USED".
- If the same frequency is stored a second time, then the existing data (frequency, label/identifier data) is offered to store.
- If the frequency has no label attached, ten underscore digits allows to insert a label. The cursor automatically appears on the first position.

The data can be stored to:

- Next free channel (offered from system).
- A selected free channel.
- A selected used channel (the existing data will be replaced).

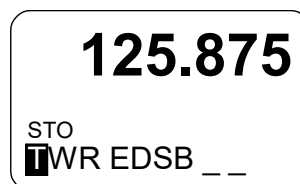
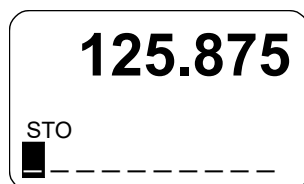
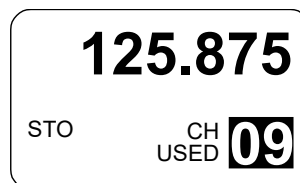

Label (Identifier) Data:

By turning the "ROTARY ENCODER" characters can be selected. Selection works in both directions (example: A→...→Z→0→...→9→—→/→blank→A" by turning clockwise and vice versa by turning counter clockwise).

Each "short press" on the "ROTARY ENCODER", the cursor is passed to the next position. A short press of the "STO" key stores the label a long press of the "STO" key clears the currently edited label. After storing the transceiver returns back to the previous frequency selection mode.

If no action occurs in label editing mode within 7 seconds, the transceiver returns to the previous frequency selection mode without storing the frequency and label information.

Stored frequencies are recallable in Channel Mode (see "Channel Mode" page 106).

3.5.5. Automatic Storage Function

The transceiver stores 9 recently selected frequencies and updates the last channels database during operation in "Standard Mode", "Direct Tune Mode" and "Scan Mode".

When changing to a new active frequency, the previous active frequency is stored "LAST" in memory LAST 1. The frequencies previously located in LAST 1...LAST 8 are shifted to memory channels LAST 2...LAST 9. This algorithm ensures the last 9 used active frequencies are available. Last used frequencies "LAST" can be recalled in channel mode (see "Channel Mode" page 106).

Note The function "LAST" and Store/Restore to channels are only available if this options are activated in "Configuration Settings" - "MEM OPTIONS".

3.5.5.1. Delete data:

The stored content in User Channel Database can only be deleted in "Configuration Settings". Please note the whole channel database will be reset.

3.5.6. Scan Mode

In Scan Mode the display shows both the active frequency on the top line and the preset frequency on the bottom line. The SCAN sign in the display indicates that scan function is active.



In all frequency selection modes;

- A long press of "↓/SCN" key activates the scan function and changes to STANDARD MODE if activated from CHANNEL or DIRECT TUNE mode.
- A short press on the "MDE" key or a long press on "SCN" key terminates scan function. After leaving scan function, the device will remain in standard mode.

The arrow sign "▶" in front of the active frequency indicates that this frequency is audible.

If both the active frequency and preset frequency simultaneously detect a signal, the active frequency (top) takes priority. The preset frequency then inverts and blinks.

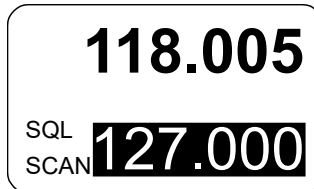

If selected in the configuration setup an audio notification "beep" tone becomes audible in addition to the blinking preset frequency to indicate the presence of an RX signal on the preset frequency.

Reception on Preset Frequency in Scan Mode

If the preset frequency detects a signal while no signal is present on the active frequency, the transceiver automatically switches over to the preset frequency.

The arrow sign now appears in front of the preset frequency and the signal is audible.

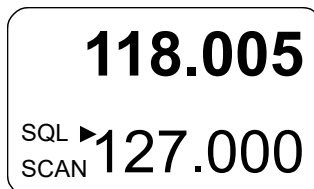

Note: Transmission always uses the active frequency, even if the monitored frequency is currently audible.
 If TX on the preset frequency is required, push the "↓/SCN" key to swap active and preset frequency.

SQUELCH

3.6. SQUELCH

Independent of the selected operation menu, squelch can be toggled "ON" or "OFF" by a short press on "SQL/IC" key.

- If the squelch function is active ("ON") the receivers noise is muted.
- If the squelch is "OFF" the arrow sign "▶" in front of the active frequency stay visible all the time and receiver noise will be audible as long as signal is receiving.



Squelch "ON"

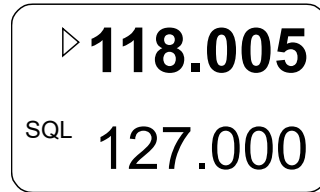

Squelch "OFF"

In the user menu, the squelch threshold is adjustable to a convenient trigger level. See "User Menu" page 114.

3.7. RX Field Strength Indication

The field strength indicator, represented by triangle on the left upper corner of the corresponding frequency, will appear next to the active or preset frequency in all frequency selection modes.

The field strength of an incoming signal relates to the measured RSSI level. The three levels displayed are:

Weak Signal Strength	Good Signal Strength	Excellent Signal Strength
RSSI passing squelch levels (empty triangle)	-88 > RSSI > -80 dBm (half-filled triangle)	RSSI > -80 dBm (fully filled triangle)

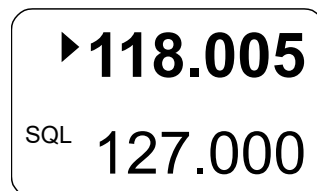
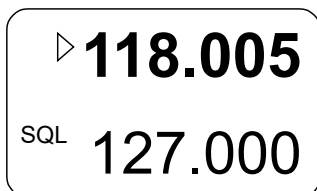

3.8. Channel Spacing Mode

The transceiver provides two operation modes of frequency channel spacing, (8.33 and 25 kHz), selectable by means of pressing "STO" and "MDE" keys simultaneously for at least 2 seconds.

In 25 kHz mode, 5 frequency digits are shown. Only operating frequencies with a channel spacing of 25 kHz are selectable. If 8.33 kHz channels are not in use, this mode provides the advantage of faster tuning since skipping the 8.33 kHz frequency steps.

In 8.33 kHz and 25 kHz mixed mode 6 frequency digits are shown. The transceiver tunes to all possible frequencies within the aviation VHF frequency band. The channel spacing and operating frequency is derived automatically from the selected and displayed frequency.

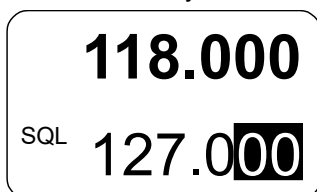

8.33 kHz channel spacing (left) / 25 kHz channel spacing (right)

Toggling between the frequency channel spacing modes is only available for AR-, RCU620X-(0XX) variants. The AR-, RCU620X-(1XX) variants provide operation in 25 kHz Mode only.

3.9. Auxiliary Audio Input

The transceiver has a dedicated auxiliary audio input e.g. for MP3 player connection.

With auxiliary input enabled in configuration setup, the auxiliary audio input signal mixing with the received signal from antenna (passing squelch) and the intercom signal (when activated).

When intercom operates in ISOLATION mode, auxiliary audio input signal is audible on headphone 2 output, even if radio communication (transmission/receiving) is active.

AUX AUTO MUTE function depends on the AUX INPUT, selectable via the CONFIGURATION page in the configuration setup. This function automatically mutes the audio signal from the auxiliary audio input as long as the AR620X detects (based on squelch evaluation) a RX signal or the user deactivates the squelch manually. If this function is disabled the signal from the auxiliary audio input is permanently audible on the audio output, independently of the received signal or the squelch status.

Automatic aux attenuation functionality controls the auxiliary audio input. The level of the auxiliary input signal attenuates if intercom is activated by VOX or by /IC discrete input. The auxiliary input signal reverts to its previous value after intercom deactivation. The attenuation value can be adjusted within the range from 0...40 dB.

3.10. Intercom Operation

Intercom operation may be triggered automatically via VOX (with adjustable threshold) or externally via intercom switch.

The setting of VOX-threshold and intercom volume is accessible in the intercom menu, in tandem configuration on primary controller only.

For a single block, the primary controller is the one directly connected to VHF transmitter. For a remote VHF transmitter the primary controller is the one connected to primary control interface.

VOX-threshold and intercom volume for the second intercom circuit are controllable from secondary controller RCU6201 (secondary controller is the one connected to secondary control interface).

The transceiver has two internal built in intercom circuits. Therefore, up to four headsets are connectable. Pilot and co-pilot connect to the first intercom circuit. When intercom is active, both microphone signals are mixed and amplified with each other and will be audible on both headphone outputs. This enables internal communication via headsets between both pilots. Passenger headsets are connecting to the second intercom circuit.

ALL mode - Everyone connected to the intercom will hear all communications (pilots hear passengers and passengers hear pilots).

ISOL mode - Provides separate intercoms for the pilots (intercom circuit one) and the passengers (intercom circuit two). This allows pilots to communicate with each other, and air traffic, while the passengers are isolated. The passengers on the intercom circuit two can hear auxiliary audio (for example from mp3 player) and can communicate with each other.

External "ISOL" input provides possibility to switch between ALL mode and ISOL mode. If the /PTT1 input is active and ISOL is active the passenger intercom operation on second intercom circuit is still possible.

While transmit mode intercom operation is degraded. During receive mode the intercom operation activates automatically via VOX (with adjustable threshold), or using the external intercom switch.

If intercom operation is active, the "IC" sign appears in the display.



Intercom Operation via VOX

Via VOX, the intercom operation is automatically activated (threshold adjustable in the intercom menu). With additional RCU6201, VOX threshold for the first intercom circuit is adjustable from primary controller (AR620X or RCU6201) and for the second intercom circuit from second controller RCU6201.

Intercom activation via VOX is not possible if:

- It is enabled
- User switched the VOX off

In both cases, VOX is disabled and the display shows the  sign to indicate that activation via VOX is not possible.



Intercom Operation via Intercom Switch

Via intercom switch (pin P1-7) independent of VOX or speaker status (enabled/disabled) the intercom operation can be activated externally. The external intercom switch has priority. During intercom operation the speaker output is disabled.

3.11. VOX & Speaker Operation

Depending on wiring and configuration setup, the speaker may either always been enabled, or the speaker can be enabled/disabled by switching configurations using external switch /MIKE_SW.

When speaker enabled and not muted, the display will show the loudspeaker sign. 



With active enabled speaker in audio configuration, VOX always forced "OFF" and intercom via VOX is not possible (to avoid oscillation of VOX due to acoustical feedback).

In transmission mode the speaker output is muted (switched "OFF") even if speaker is enabled in current audio configuration in one of the following cases:

- Intercom is activated by external intercom switch (I/C input).
- Power is below 10 V.

3.12. Menus

During normal operation in one of the frequency selection modes, the following menus are available:

- The Intercom menu allows adjustment of intercom volume and VOX threshold.
- The user menu allows adjustment of panel brightness and squelch threshold.

3.12.1. Intercom Menu

A long press (2 s) on "IC/SQL" key activates the intercom menu. The page intercom volume appears. In this menu a short press on "IC/SQL" key provides toggling between the pages.

The intercom menu consists of two pages:

- IC VOLUME,
- IC VOX.

A long press on "MDE" key terminates intercom menu, otherwise the menu automatically terminates after 5 seconds timeout.

Intercom Volume Menu

The active frequency is indicated in the top line of the display, the "IC VOLUME" label and a bar graph with numerical value are shown in the bottom line.

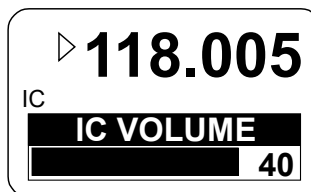

By means of the "ROTARY ENCODER", the intercom volume is changeable from zero to 46. The intercom volume setting affects the intercom audio and sidetone signal, routed to the headphone.

The changes become active immediately.

Intercom VOX Menu

The active frequency is indicated in the top line of the display, the "IC VOX" label and a bar graph with numerical value are shown in the bottom line.



By means of the "ROTARY ENCODER" the intercom VOX threshold can be changed from -30 (most sensitive, even a very low microphone signal already triggers the VOX threshold for Intercom operation) to +10 (VOX is less sensitive and only high microphone signals trigger the VOX threshold for intercom operation).

Note: At a setting for VOX threshold of -15 a convenient behaviour of the VOX should be achieved in most aircraft. This requires that mike sensitivity had been correct adjusted (configuration setup). If the mike sensitivity is incorrect adjusted, VOX may not work satisfying.

By changing VOX threshold level to above +10, VOX switches "OFF". In this case, "OFF" replaces the numerical value indication.

The changes become active immediately.



With VOX switched "OFF", activation of intercom operation using the external intercom switch (/IC discrete input) is still possible at any time. The VOX threshold level is not adjustable if VOX forced to be "OFF" (due to enabled speaker in current audio configuration).

In tandem installation the "first" controller adjust VOX threshold for first intercom circuit, and the second controller RCU6201 adjust VOX threshold for second intercom circuit.

3.12.2. User Menu

Press the "MDE" key for 2 seconds to start the user menu. Toggling between the pages by a short press of the "MDE" key, or by a short press of the "ROTARY ENCODER".

The user menu consists of two pages:

- BRIGHTNESS
- SQUELCH TRH

To exit the user menu either

- Wait 5 seconds without any switch selections.
- Press the "MDE" key again for 2 second,
- Press the "ROTARY ENCODER" when the SQUELCH setting page is visible,

BRIGHTNESS

The active frequency appears in the top line of the display "BRIGHTNESS" label appears in combination with a bar graph and the selected value.



The panel brightness for display illumination and push buttons can be changed from 0 (illumination off) to 100 (maximum brightness) by turning the "ROTARY ENCODER".

Note: This page is not available if in configuration setup the dimming input is set to 14 V or 28 V. For this setting, the aircraft dimming circuit controls the brightness parameters.

SQUELCH

A short press on the "ROTARY ENCODER" provides "SQUELCH" trigger level adjustment. The active frequency appears in the top line of the display. On the bottom line "SQUELCH" with bar graph and value is indicated.

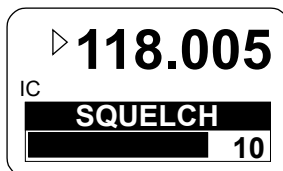

By means of the "ROTARY ENCODER", the squelch threshold is adjustable:

- At a setting to 6 (very weak signals are audible with high noise content; squelch opens at about -105 dBm).
- At a setting to 26 (only quite strong signals are audible with low noise content; squelch opens at about -87 dBm). With this adjustment the receiver sensitivity is significant reduced.

3.13. Warning and Failure Indications

Display Contents	Description
<div style="border: 1px solid black; border-radius: 10px; padding: 10px; text-align: center;"> <p>IC</p> <p>118.005</p> <p>LOW BATTERY</p> </div> <p>Appear in 3-second cycle</p>	<p>"LOW BATT" is indicated if the supply voltage of the transceiver is below the threshold defined in the configuration setup.</p> <p>The transceiver is still operable but may have a reduced performance depending on supply voltage.</p> <p>Possible reasons for indication:</p> <p>Accumulator capacity problems (gliders), Power interrupts, General power supply problems, Setting for low battery threshold too high</p>
<div style="border: 1px solid black; border-radius: 10px; padding: 10px; text-align: center;"> <p>IC</p> <p>118.005</p> <p>STUCK PTT</p> </div> <p>Appear in 3-second cycle</p>	<p>"STUCK PTT" is indicated after 120 seconds of continued transmission. The transceiver goes back to receive mode even if the PTT line is still active (GND).</p> <p>For initiating a new transmission, the PTT line needs first to become inactive (open).</p> <p>Possible reasons for indication:</p> <p>Transmission lasts more than 120 seconds. PTT-key is stuck. PTT line permanently grounded (short circuit in installation).</p>
<div style="border: 1px solid black; border-radius: 10px; padding: 10px; text-align: center;"> <p>IC</p> <p>118.005</p> <p>TX HOT</p> </div> <p>Appear in 3-second cycle</p>	<p>"TX HOT" is indicated if the internal device temperature exceeds +90 °C.</p> <p>Transceiver is still operable. Performance of transmitter is reduced.</p> <p>Possible reasons for indication:</p> <p>Very hot environmental temperature, long transmissions times and insufficient airflow conditions.</p>
<div style="border: 1px solid black; border-radius: 10px; padding: 10px; text-align: center;"> <p>IC</p> <p>118.005</p> <p>FAILURE</p> </div> <p>Appear in 3-second cycle</p>	<p>The transceiver has detected an internal failure during normal operation.</p> <p>Depending on failure reason, the device may still be operable with degraded performance, or not operable at all.</p> <p>Possible reasons for indication:</p> <p>Specified environmental conditions HW or SW failure inside the transceiver.</p> <p>Contact maintenance shop for assistance.</p>
<div style="border: 1px solid black; border-radius: 10px; padding: 10px; text-align: center;"> <p>FAILURE</p> <p>PRESS ANY KEY</p> </div>	<p>The transceiver has detected an internal failure during start up.</p> <p>Depending on failure reason, the device may be still operable with degraded performance or not operable at all.</p> <p>Possible reasons for indication:</p> <p>Outside specified environmental conditions HW or SW failure inside the transceiver.</p> <p>Contact maintenance shop for assistance.</p>
<div style="border: 1px solid black; border-radius: 10px; padding: 10px; text-align: center;"> <p>FAILURE</p> </div>	<p>The transceiver has no communication with the controller.</p> <p>Depending on failure reason, the device may be still operable with degraded performance or not operable at all.</p> <p>Possible reasons for indication:</p> <p>Problem with inter-wiring</p> <p>Contact maintenance shop for assistance.</p>

In case of additional questions contact your local Becker Avionics dealer or forward your request direct to Becker Avionics "Customer Service".

In the event of damage or a defect, the entire device must be returned for repair. The repair must be made by trained Becker Avionics personnel.

Becker Avionics GmbH • Baden-Airpark B108 • 77836 Rheinmünster • Germany

☎ +49 (0) 7229 / 305-0 • Fax +49 (0) 7229 / 305-217

Customer Service:

Sales

Email: sales@becker-avionics.com

Support in German or English

Email: support@becker-avionics.com

Support in French

Email: FR-sales@becker-avionics.com

User Conversions and Changes are Not Permitted

Any change made by the user excludes any liability on our part (excluding the work described in this manual).

4. Index

Abbreviations	7	List of Abbreviations	7
Accessories	31	LOW BATT Indication	20
Activation of Intercom Operation via Intercom Switch	112	Memory Channels	20
Activation of Intercom Operation via VOX	112	Menus	113
Additional Conditions of Utilization	9	Mike Inputs	19
AF Auxiliary Input	19	Non Warranty Clause	9
ALL Mode	111	Operation Instructions	99
Antenna Installation	53	Packaging, Transport, Storage	33
AR6201 Single Block Transceiver	17	PBIT	20
AR6203 Single Block Transceiver	17	User Menu	114
Audio Outputs	19	Post Installation Tests	93
Automatic Storage Function	108	Purpose of Equipment	13
Auxiliary Audio Input	111	RCU6201 Remote Control Unit	18
BRIGHTNESS	114	Receive and Transmit Mode	102
Built-in Tests PBIT and CBIT	20	Receive Mode	102
CBIT	20	Reception on Preset Frequency in Scan Mode ...	109
Channel Mode	106	Retrofitting	90
Conditions of Utilization	9	RT6201 Remote Transceiver	18
Controls and Indicators	101	RX Field Strength Indication	110
Device Assignment	34, 100	Sales	117
Direct Tune Mode	104	Scan Mode	20, 109
Electrical Interface	44	Scope of Delivery	34
Emergency Operation	20	Service Mode	21
Environmental Qualification AR620X, RCU6201 ...	26	Side Tone	19
Environmental Qualification RT6201	27	Squelch	110
Factory Default Settings	69	SQUELCH	115
Features Overview	19	Squelch Operation	20
Frequency Selection Modes	103	Standard Mode	103
General Description	11	Support	117
General Safety Definitions	8	Support in French	117
Illumination	20	Tandem Operation	20
Installation	33	Technical Data	22
Installation and Configuration	53	Transmit Mode	102
Configuration Setup	21, 54	Trouble Shooting	96
Intercom Menu	113	Units	8
Intercom Operation	20, 111	Variants Overview	14
Intercom Volume Menu	113	VOX & Speaker Operation	112
Intercom VOX Menu	113	Warning and Failure Indications	116
ISOL Mode	111	Warranty Conditions	9
		Wiring Diagrams and Settings	71

We reserve the right to make technical changes.
The data correspond to the current status at the time of printing.
© 2016 by Becker Avionics GmbH / all rights reserved

*** End of the Document ***

ACL

K-DUO

Operation :

Switch ON = flash active

Switch OFF = flash not active

Emergency operation :

In the event of a malfunction or failure, the system must be switched off immediately and must stay off for the remaining flight time. Never switch on the system again inflight, after or while persisting errors.



Caution, high intensity optical radiation!



Handling on ground: do not look directly into the light!



Avoid direct contact with water!



OPERATING MANUAL FLARM COLLISION WARNING UNIT

Status

Software Version 5.00 (March 01, 2011)

This is a translation of the German manual.

© 2003-2011 FLARM Technology GmbH
Baar-Switzerland
www.flarm.com
info@flarm.com

1. Welcome to the FLARM user community

Thank you for purchasing FLARM, a modern low-cost collision-warning unit for sailplanes and light aircraft. The main task for FLARM is to support the pilot, while he scans the airspace ahead with his own eyes. FLARM is simple to use and does not distract the pilot from the main business in hand.

 Sport flying is an activity that is associated with considerable risks for crew, passengers, third parties and other objects. **In order to make full and safe use of FLARM, it is absolutely essential to be fully aware of the risks, operating conditions, restrictions and limitations associated with the use of FLARM, ensure a proper installation and do regular software updates. This includes familiarity with and observance of this Operating Manual and the Installation Manual.** Additional configuration information can be found in the 'Data Port Specifications' document, e.g. how to suppress additional data at the serial port what might be required in international championships.

We welcome user feedback and reports, suggestions for improvements, and pictures that will help us make further improvements to FLARM. Feedback reports should give a detailed description of the situation, quoting the Hardware and Software versions used, plus the flight data records in IGC format with short time recording intervals.

The latest version of this handbook and other related documents can be found at the Website www.flarm.com. This Website also has answers to Frequently Asked Questions.

This Website also carries announcements when new software versions or functions become available. If you enter your name on the mailing list, you will automatically receive notification of changes as and when they happen: https://lists.flarm.com/mailman/listinfo/user-list_flarm.com

To use existing devices in March 2011 or later, it is required to update the software to version 4.00 or higher. Use the free PC installation software available at www.flarm.com. You need a PC with Windows 98 / ME / 2000 / XP with a serial port or a suited USB-serial converter plus a data-power cable like the one used for most IGC flight recorders. This cable connects the PC to FLARM and supplies FLARM with power. Ensure you have configured the correct PC COM-port, only use the Power/Data-port on FLARM (not the Extension-port) and know the printed device serial number. After completion of the software update, use the same PC software to load the most recent obstacle file to FLARM; this file is available on www.flarm.com as well. Then use the PC software to configure the flight recording functionality accordingly. In case of questions, contact your FLARM dealer.

 Software-Versions 5.x must not be used after **March 01, 2015**. Before this date, you must update the device in order to use it in the air.

2. How it works

FLARM receives position and movement information from an internal 16 channel GPS receiver with an external antenna. A pressure sensor¹ further enhances the accuracy of position measurements. The predicted flight path is calculated by FLARM and the information - including a unique identifier - transmitted by radio as low-power digital burst signals at one-second intervals. Provided they are within receiving range, the signals are almost at the same time received by further aircraft also equipped with FLARM. The incoming signal is compared with the flight path predicted by calculation for the second aircraft. At the same time, FLARM compares the predicted flight path with known data on obstacles, including electric power lines, radio masts and cable cars.

If FLARM determines the risk of dangerous proximity to one or more aircraft or obstacles, the unit gives the pilot warning of the greatest danger at that moment. The warning is given by a whistle sound (beep) and bright light emitting diodes (LED). The display also gives indication of the threat level, plus the horizontal and vertical¹ bearing to the threat. During circling flight different methods of calculation are employed to those used during straight flight.

The GPS and collision information received from other aircraft can also be made available for third party equipment (e.g. external display, speech synthesizer, PDA) via a serial data output. Such equipment is available from a number of manufacturers.

¹ Requires Hardware Version 2 or higher. However, the vertical bearing on the serial data output is also available to third-party equipment on Hardware Version 1.

The operating range is very dependent upon the antenna installation in the aircraft. The normal range is about 2 km. In individual cases the range may be up to 5 km, which can be valuable for fast sailplanes with a speed of up to 250 kt, providing the pilots in both aircraft with a warning enabling visual identification and reaction to the potential hazard. The effective range can easily be verified with an online tool². Warnings are given in order of the time remaining before a potential collision, not the geometrical distance. The first warning level for another aircraft or an obstacle is delivered when less than 18 seconds remain to the possible collision; the second warning level is delivered when less than 13 seconds remains; the third level when less than 8 seconds remains.

The warnings continue as long as FLARM calculates a threat of collision. The warning level may decline or be cancelled, depending upon the prediction. The warnings are selective; they are only issued if the calculation reveals a high probability of collision in the near future. The alarm sensitivity can be configured with the PC.

In addition, FLARM operates as an IGC-file compatible flight recorder including the G-record. Flight logs can be read out either via the SD-card or via the data port and a suitable cable. The SD card does not need to be carried on during the flight. FLARM is optionally also available as diamond-level IGC-*approved* Flight Recorder, optionally with Engine Noise Level sensor (ENL).

With the standard April 2008 obstacle databank there is memory for more than 50 hrs of flight recording at a 4s interval. Use the free PC-software to download flights to your PC and to properly configure your device for flight recording. Flight recording automatically starts when the aircraft is moving and ends when the unit is switched off. Switching off the device during the flight for a longer period results in separate flight record files. Allow at least 2 minutes (if the interval is 4s, our recommended value) after landing before you switch off the device else you lose the last part of the flight. Allow more time after landing if the interval is higher. When the memory is full, the oldest data is overwritten. Always download your flight data before you update the obstacle databank or the software.

FLARM applies for the radio communication between the units a proprietary patent- and copyright-protected protocol. It is not public, but FLARM Technology offers a license contract where it is accessible in the form of a compatible core design ready for integration into 3rd party systems. These systems are officially declared as FLARM-compatible. Any non-licensed use, dissemination, copying, implementation or reverse engineering of the FLARM radio communication protocol, the FLARM hardware and software or parts of it is forbidden by law and will be prosecuted. FLARM is a registered trademark and can not be used without license.



3. General Advice on Operation

This Manual must be carried on board the aircraft. When permanently installed in an aircraft, the 'AFM Supplement' must also be carried in the aircraft.

In flight the pilot must have direct sight of and immediate access to a switch or circuit breaker that disconnects FLARM from the aircraft electrical power supply, without affecting other essential aircraft systems. This might be necessary if the pilot suspects that FLARM may be interfering with another on-board system, the suspected presence of smoke, the smell of smoke, or flying in a country where the use of FLARM is not permitted.

FLARM must not be operated at night or with night vision systems.

FLARM will not operate without adequate GPS signal strength. Correct antenna installation has a great effect on the transmission/receiving range.

FLARM is not able to measure its own RF-receiver sensitivity. When the pilot detects that other aircraft are received only when very close or not at all and when the RF-antenna's positioning is clearly not the cause of it, the device must be checked by the manufacturer.

² www.flarm.com/support/analyze

Installation and operation must be on the basis of non-interference with and no hazard to the existing suite of other certified equipment necessary for safe flying operation, or installed to comply with official requirements. Installation and operation must comply with official regulations and requirements. It is recommended that the FLARM, GPS and radio antennae are all installed as far away as practicable - but at least 25 cm from - susceptible aircraft systems such as GPS antennae and the magnetic compass.



The unit must be protected from solid particles or liquids, should not be exposed in use to temperatures below -10°C or above +60 °C , or stored at temperatures -20°C or above +70 °C, because this may cause irreparable damage. On the ground, the unit should be protected from exposure to long periods of direct sunlight, because it is likely to be overheated. Also avoid static discharges to the radio antenna.



Details on correct installation will be found in the Installation Manual.

4. Operating Modes

FLARM operates in two modes, *Nearest* and *Collision*. The change from one mode to the other is effected by a two-second push on a button followed by a brief visual confirmation from the unit. After the change has been signalled, the current mode selected is not displayed. When switched on, the unit is in *Nearest* mode.

 The warnings given are identical in both modes, and generally relate to an immediate threat to which the pilot should make an immediate and appropriate reaction. The assumption has been made that following a warning it will take up to 12.5 seconds from the time that the other aircraft is seen, until a change in flight path has removed the threat³.

When operating in the *Nearest* mode, the unit also reports the presence of other aircraft operating in the vicinity, even though calculations indicate that they do not represent a threat. The information displayed is limited to a configurable radius (default is three kilometres) and a vertical separation of 500 m. When no aircraft was displayed so far but one is received now, this is signalled with a click-sound. Only one single aircraft is indicated, with Hardware Version 3 or later in green. The optical signal is static (no flashing); the threat intensity is not indicated and there is no sound warning. As soon as FLARM detects the risk of a collision it automatically switches to *Collision* mode, followed by automatic reversion to *Nearest*. The choice of mode is presented, such that immediately after pressing the key, the display presents a diverging pattern (Hardware Version 1 and 2:  ; version 3: ).

When operating in the *Warning* mode a red LED lights up only if the calculation predicts a threat. Warnings are always shown by flashing LEDs, the threat level being shown by the number of LEDs illuminated, by the frequency of flashes, and the simultaneous sound signal (beep). Selection of this mode is indicated by a upwards converging pattern (Hardware Version 1 and 2:  ; Version 3: ) immediately after pressing the selector key.

In both modes the pilot can **suppress the display and the acoustic warning**: after a double push FLARM will suppress all visual and acoustic signals relating to traffic, obstacles or other threats. The act of selecting suppression is followed by a descending tone. A further double-push reinstates the *Collision* mode at once and is followed by a rising tone. While warnings are suppressed, FLARM nevertheless continues to transmit signals for reception by other aircraft.

³ These times were published in 1983 FAA Advisory Circular 90-48-C and were based on military data. They relate to fast jet pilots with no on-board warning systems for other traffic and hazards. The assumption was made that only one aircraft takes avoiding action. Of the 12.5 seconds, five seconds were to recognise the threat of collision and four seconds were required to decide upon avoiding action. No information is available as to whether these times are applicable to light aircraft, sailplanes or helicopters, when using a warning system.

5. Front Panel

The dark grey front panel of Hardware Versions 1 and 2 has a push-button, four green Status-LEDs, ten red collision warning LEDs and four red LEDs for vertical¹ position indication.

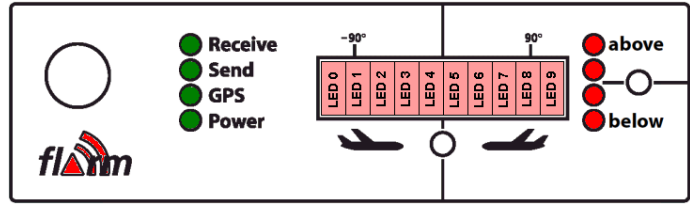

Push-button 4 green LED (Status) 10 red LED (horizontal) 4 red LED (vertical¹)

The front panel of Hardware Version 3 has a push-button, four green Status-LED, twelve bicolour LED for horizontal and four bicolour LED for vertical position indication. Depending on the threat caused by other aircraft or obstacles the LED show up red or green. Also included is a microSD-reader which can be used for updates, downloads and configurations. microSD cards are not included, but widely available in electronic and mobile phone shops.

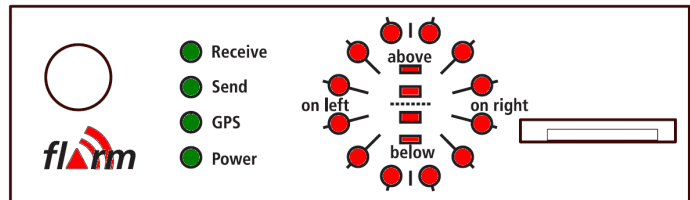

Push-button 4 green LED (Status) 12 LED (horizontal) 4 LED (vertical) all bicolour microSD reader

6. Start-Up

FLARM is always switched on if the unit is connected to an adequate power supply.

Immediately after it has been switched on there follows a one-second long beep while a start-up pattern might be shown on the LED, followed by a binary presentation of the Hardware-Version installed during the system self-test. The self-test mode lasts around 8 seconds, depending upon the size of the obstacle data bank.

0x01 Hardware Version 1 (only red)



0x02 Hardware Version 2 (only red)



This is followed by another one-second beep, followed by a binary presentation of the Software-Version:

- Hardware Versions 1 and 2: LED0 to LED3 represent the major versions, LED4 to LED9 the minor versions. Everything is shown in red.

If the Software Version is not indicated and the beep sound is not emitted, the unit is not ready for operation.

Software Version 1.xx (operational only to April 2005)

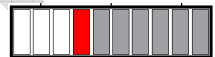

Software Version 2.xx (operational only to Feb 2006)



Software Version 3.xx (operational only to March 2008)



Software Version 4.xx (operational only to Feb 2011)



Software Version 5.xx (till March 01, 2015)

















Then FLARM shifts to normal operation and waits until it has acquired an adequate GPS position fix. When switching on, this procedure can take *several minutes*. Without a proper GPS position fix, the unit is not ready for operation. Before departure the pilot must ensure that at least the Power-, GPS- and Send-LED are all continuously on. This state must be preserved during the whole flight to ensure correct operation.

7. Fault Finding

If a fault should occur during start-up self-test or subsequent operation, then all four green status LEDs will flash in unison for 30 seconds, while the red collision LEDs will give a binary indication of the most serious fault. The fault display can be stopped before 30 seconds has elapsed by pushing the button.

 For safety reasons FLARM will not start up if there is a fault. FLARM may not be used if a fault has been reported or indicated. Limited operation is possible if there is an indication of a problem with the obstacle data bank or data recorder.

0x11	Fault: Software out of date (needs GPS reception)	No operation	
0x12	Fault: Software integrity violation (only IGC-units on F5)	No operation	
0x21	Fault: Low Voltage	No operation	
0x31	Fault: Internal GPS communication	No operation	
0x32	Fault: Faulty GPS configuration	No operation	
0x41	Fault: Internal radio communication	No operation	
0x51	Fault: General internal communication	No operation	
0x61	Fault: Flash memory	No operation	
0x71	Fault: Pressure sensor	No operation	
0xF1	Fault: Other fault	No operation	
0x81	Indication: No obstacle data bank	Operation possible	
0x91	Indication: Flight recording not possible	Operation possible	
0x93	Indication: ENL recording not possible (only IGC-units on F5)	Operation possible	
0xA1	Indication: Error with SD-card configuration file	Operation possible	

The communications faults itemised above indicate if internal modules within FLARM are not communicating correctly with each other. For reasons associated with the system, reduced radio range cannot be detected by a single unit alone.



Software-Versions 5.x must not be used after March 01, 2015. Before this date, you must update the device in order to use it in the air. An update with the same functionality can be downloaded free of charge. Users will be able to load the software with the aid of a suitable power supply/data cable (not supplied). This operation requires the user to have the unit Serial Number to hand. Software validity has to be time-limited to ensure that all FLARM units are mutually compatible and that updates include the latest obstacle data.

8. Status-Display

The green Status Display LEDs operate as follows; normal operating mode is underlined:

- **Receive:** Lights up when a signal is detected from another aircraft less than the configured range (default is 3 km) away, with a height separation of less than 500 m; otherwise the LED is dark. If the warning is temporarily suppressed (see below) but signals are still received from other aircraft, then the LED flashes.
- **Send:** Lights constantly during operation and indicates that the on-board FLARM is transmitting. Transmission requires GPS reception.
- **GPS:** Lights constantly during operation (with very brief interruptions once per second). If the LED is constantly dark and flashes briefly once per second, then there is no GPS reception. When switching on this condition can take several minutes.
- **Power:** Lights constantly during operation. If the LED flashes, then the power supply has dropped below 8 V. FLARM will not operate below 8 V DC.

The 'Receive' and 'Send' LEDs give no indication of FLARM's transceiver range.

9. Push Button⁴

The push button can be used to select the following functions:

- **Brief Push** (<0.8 s) changes the volume from *<loud>* to *<medium>* to *<quiet>* to *<silent>* (and *<loud>* again). A short sound is emitted at the new volume selected. The default setting is *<loud>*.
- **Longer Push** (2 s) changes mode between *<Nearest>* and *<Collision>* when airborne. Visual confirmation. Default setting *<Nearest>*.
- **Longer Push (5 - 8 s, only on the ground)** activates the receiver self-test: Two seconds after the button is released, FLARM will show how many other FLARM are received with reduced sensitivity (50% of the normal range). It will then emit a long beep and light one vertical LED for every 10 and a short beep and one horizontal LED for every single received aircraft (e.g. 14 received FLARM is: "beeeeep bep bep bep bep", with one vertical and 4 horizontal LED's). After the self-test, FLARM switches back to normal operations. Note that for other units to be displayed these must be running.
- **Double Push** suppresses optical and acoustic warnings for five minutes. Suppression is followed by declining melody, normal setting followed by a rising melody. A double push terminates the suppressed operation at once.
- **Long Push** (>8 s): Re-boot. This procedure is recommended if a fault is apparent. No confirmatory sound signal.
- **Very long push** (>20 s) brings FLARM back to the factory settings. The very long push deletes all configurations that have been loaded by the user. No confirmatory sound signal.

⁴ Activate the external display update by pushing the button four times in rapid succession. For details see the Installation Manual.

10. Aircraft Anti-Collision Warnings

An illuminated red LED indicates the approximate bearing to an aircraft currently posing the biggest threat of collision. The bearing is *relative to the track*. This indication is inaccurate if there is a strong wind, if the aircraft is in a sideways yaw, or if ground speed is very low (e.g. when a helicopter is in the hover). The display is refreshed every second.

The unit emits an audio warning (beep) tone at the same time as the flashing red optical warning. The time between the warning and possible collision is brief, just a few seconds. Warnings of fixed obstacles are given slightly earlier.

Horizontal bearing indicated on Hardware Versions 1 and 2

Each red LED is allocated to a sector of sky around the aircraft horizontal plane in a side view. The aircraft centreline is indicated by a white line above and below the mid point (between LED4 and LED5). A short white line is located above LED1 and LED8, marking 90° left and right.

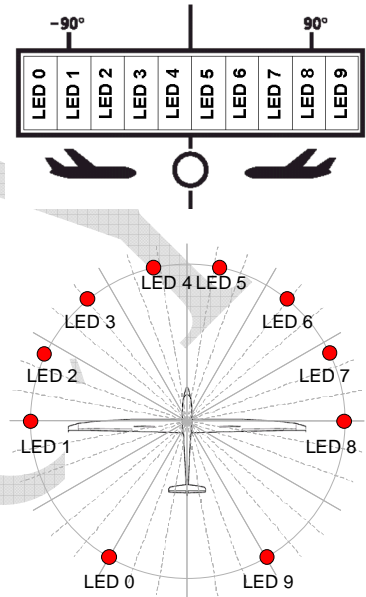

- LED 0 ~210° quadrant rear left
- LED 1 270° hard left 9 o'clock
- LED 2 296° left 10 o'clock
- LED 3 321° left 10-11 o'clock
- LED 4 347° front left 11-12 o'clock
- LED 5 13° front right 12-1 o'clock
- LED 6 39° right 1-2 o'clock
- LED 7 64° right 2 o'clock
- LED 8 90° hard right 3 o'clock
- LED 9 ~150° quadrant rear right

Horizontal bearing indicated on Hardware Version 3 and later

The twelve bicolour LED show a compass rose, i.e. the birds view on the traffic situation. 'Top' is track-up according the own aircraft. Each LED covers an equal-sized horizontal sector of 30°.

Danger from the front or side

If the threat of collision with another aircraft is from the front or side, but not from the rear, then the threat level will be flagged up by the display. If the threat is moderate (less than 18 seconds to possible collision), a single LED lights up; in the case of a medium threat (less than 13 seconds) then two diodes light up; if the threat is imminent (less than 8 seconds) three LEDs. The threat is at the centre of the illuminated block. The flash and beep frequency increases with the threat.

Moderate threat from ca. 3 o'clock
(less than 18 seconds to calculated collision)

Slow flash at 2Hz



Moderate threat from 1 to 2 o'clock
(less than 18 seconds)

Slow flash at 2Hz

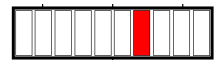
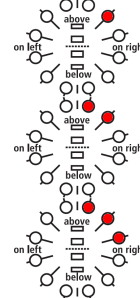

Medium threat from 1 o'clock
(less than 13 seconds)

Medium flash at 4Hz

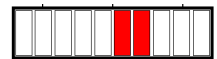

Immediate threat from 1 to 2 o'clock
(less than 8 seconds)

Rapid flash at 6Hz

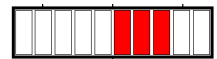
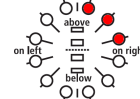

Danger from the rear

If the threat is from behind, then the threat level on Hardware Version 1 and 2 is given only by the frequency of LED flashes, not the number of LEDs activated.

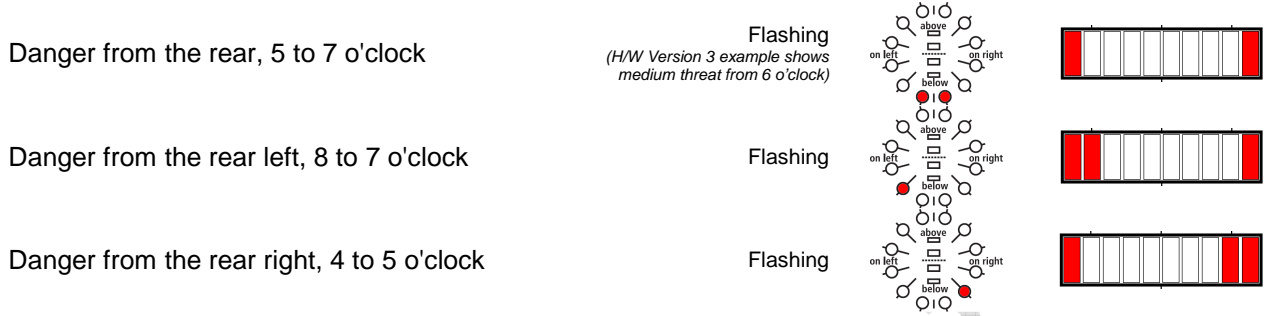

Vertical indication

The vertical bearing is indicated by a vertical¹ line of four red LEDs and show the bearing relative to a horizontal plane. This is independent of the aircraft's climb angle. The uppermost or lowest LEDs illuminate when the bearing exceeds 14°. The LED flash frequency is identical and synchronous with that of the horizontal display.

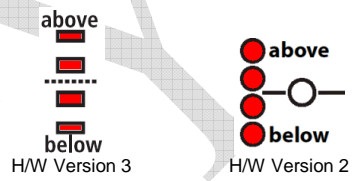

Traffic indication (only in Nearest-mode)

In Nearest-mode the closest aircraft is shown as long as no warning is necessary. Traffic indications don't flash, there is no sound and the distance is not shown. Hardware Version 3 and higher show traffic indications in green.

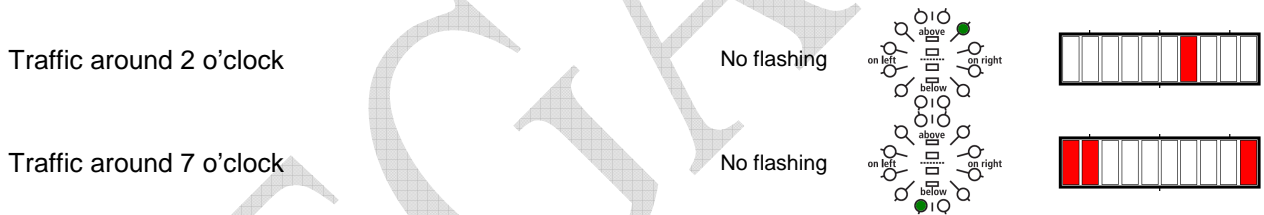

11. Obstacle Warnings

The standard obstacle data bank (as of Feb 2011) has about 35,000 coordinates locating about 11,000 Alpine obstacles⁵. This data bank is loaded by FLARM at manufacture; subsequently the user may upload but not alter up-dated information via a PC. Special data banks, corrections and amendments can be reported to us.

The FLARM display flashes when there is warning of obstacles. The warning always relates to obstacles straight in-line with the current flight heading. In other words there is no horizontal or vertical bearing given to the obstacle. The threat level depends upon the time remaining to impact; the flash and beep frequency increases with reducing distance from the obstacle. The display is refreshed every second.

A warning is given if an aircraft flies under a cable or power line.

An acoustic warning (beep) is given at the same time as the flashing fixed obstacle warning. The time between warning and possible collision is brief, just a few seconds. However, warnings are given of fixed obstacles earlier than those for other aircraft.

Hardware Versions 1 and 2 show obstacles as follows:

- Moderate threat
(less than 18 seconds to calculated collision)
- Medium threat
(less than 13 seconds)
- Immediate threat
(less than 8 seconds)

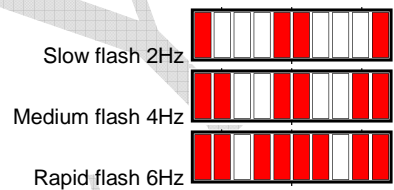

Hardware Versions 3 and later show obstacles as follows:

A toggling pair of two LED's is shown, with the toggle frequency depending on the threat.

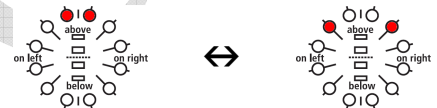

⁵ For details on the data sources and status, consult the 'Obstacle Data Format Specifications' manual.

Neither FLARM Technology nor these organisations accept any responsibility for the accuracy, completeness or up-to-date status of the data or any direct or indirect damage resulting from using such data. Official data sources only collect data which have been reported by those who own, construct or operate constructions which represent an obstacle, and do not check these reports.

12. Operating Limitations



FLARM is designed and built as a non-essential 'situation awareness only' unit to only support the pilot, and cannot always provide reliable warnings. In particular, FLARM does not give any guidance on avoiding action. Under no circumstances should a pilot or crewmember adopt different tactics or deviate from the normal principles of safe airmanship. Even with FLARM installed, you remain responsible for flying the aircraft and ensure the safety of passengers and other traffic. The use of FLARM is solely at the discretion of the commander and his delegated crew member. Operation must be preceded by thorough familiarisation by the commander or his delegated crew member with the Operating Manual.

FLARM will only give warnings of other aircraft that are likewise equipped with a compatible unit. FLARM does *not* communicate with Mode A/C/S transponders and is not detected by ACAS/TCAS/TPAS or Air Traffic Control. Likewise FLARM does not communicate with FIS-B, TIS-B or ADS-B.

Compatible FLARM units must be within range in order to provide a warning. The range is very much determined by the type, installation and position of the radio antennae, plus the relative positions of the two aircraft. Under *optimum* conditions the internal antennae can give a head-on range of up to 5 km; normally, range is about 2 km, which is adequate for light aircraft and sailplanes. The radio signals can only be received by *line of sight*. There is no FLARM signal between two aircraft on opposite sides of the same mountain.

FLARM has to know its *current* position in order to operate. For this reason, FLARM will only operate in the presence of good quality three-dimensional GPS reception. GPS reception is greatly influenced by the installation and position of the antenna, and aircraft attitude; furthermore, it requires that the US-american GPS-system is fully operational. This is particularly true during turns, when flying close to mountain slopes and in areas known for poor reception. If the installation is poor the GPS signal quality may be reduced. In particular, there can be rapid degradation of height calculations. FLARM resumes operation as soon as the GPS reception quality is adequate.

Movements calculated by the GPS relate to a fixed system of *terrestrial* coordinates. In strong wind there may be a substantial difference between aircraft heading and track, leading to a distortion of the threat bearing. If the wind speed is one third of True Airspeed (TAS) and the yaw-free aircraft Heading is 90° out of wind, then the threat indication displayed has an error of about 18°. If the wind is very strong, the Track can deviate up to 180° from Heading. Under such circumstances and when circling, the calculation and warnings given are unusable.

When close up, when two aircraft are at the same or similar height, or GPS reception is poor, the vertical bearing indication is imprecise and fluctuates.

FLARM calculates the predicted flight path of the aircraft to which it is fitted for less than the next 20 seconds. This prediction is based on immediate past data, current position- and movement data, plus a movement prediction model that is *optimised for the respective user*. This forecast is associated with a number of uncertainties that increase with an extension of the forecast time. There is no guarantee that an aircraft will actually follow the predicted flight path. For this reason, the warning issued will not be accurate in all cases. In sport flying flight path predictions of more than 30 seconds are *unusable*. This is particularly true for sailplanes and hang gliders. For this reason, the radio range is generally adequate.

Warnings are given at very short notice, i.e. the warning is given within a time frame of from a few seconds to 18 seconds, depending upon the closest predicted proximity, as calculated. The threat intensity (pitch of the warning tone, LED block width, flash interval) flags up the threat (collision time point), but not the geometric distance. FLARM only issues a warning if the calculation forecasts a *considerable* threat. For this reason, it is usual - depending upon the mode selected - that no warning is given about the presence of other aircraft, in spite of the fact that signals have been correctly received.

When a number of moving threats or fixed objects are within range, then FLARM gives warning only of the most dangerous in accordance with the threat calculation algorithm. The pilot is unable to confirm receipt of this warning, nor is he able to call for presentation of further threats. In spite of the warning issued for one other aircraft or fixed objects, it is quite possible that there are several further aircraft or fixed objects that represent a greater threat than that which has been signalled. When the unit simultaneously detects a threat from moving and fixed obstacles, then the warning issued relates to the earliest likely collision.

FLARM indicates the rough position of the aircraft or obstacle that currently represents the biggest threat, in accordance with the algorithmic calculation; FLARM Hardware Version 2 (and onwards) also displays a vertical bearing. In the case of fixed obstacles, the unit does not signal a bearing. FLARM does not indicate where the closest proximity may occur, nor does it signal avoiding action. Whether and how avoiding action is taken is solely a matter for the pilot, who must base his decision on his own observation of the airspace. In taking his decision, he must comply with the Rules of The Air and ensure that no additional hazard is caused by his action. Depending upon the phase of the flight, FLARM uses different forecasting methods, movement models and warning calculations, to provide the pilot with the best possible support without causing a distraction. For example, when a sailplane is circling, the system sensitivity is reduced. These models and processes are optimised, but are nevertheless a compromise. As seen by the pilot these models are the source of 'false alarms'; i.e. FLARM would give warnings of 'threats' that would not subjectively be regarded as a real danger. It is quite possible that FLARM will not give warning of the highest threat, or will give any warning at all.

Obstacle warnings (e.g. cables, antenna masts, cable cars, avalanche dynamite wires, power lines) are dependent on the information having been stored *correctly* in the internal data bank. The unit cannot give warning of any fixed object that has either been incorrectly stored, or not stored at all. No data bank is complete, up-to-date and correct. Obstacle information stored has usually been simplified; for example, FLARM assumes that a power wire is slung absolutely straight between two fixed points with no sag. Likewise, data for power lines and cable cars does not include all intermediate masts. In addition, FLARM data does not include terrain data and no such warnings are possible.

FLARM radio communications take place in a license-free band in which there is general freedom to transmit and receive. This means that the band is also available to a number of other uncoordinated users. FLARM has no exclusive right to the use of this band and there is no guarantee that FLARM will not be subject to interference by third parties.

There are national differences in frequency allocation and operating conditions between countries. The aircraft commander and user are solely responsible for ensuring that their use of FLARM conforms with local regulations. No radio licence is required for FLARM in Switzerland, Germany and France.

The radio transmission protocol employed places *no limit* on the number of units that may be operated within a given range. However, an increasing number of units within range is associated with a reduction in the probability that a single coded signal will be received ('graceful degradation'). The probability is small that subsequent signals will not be received from the same transmitter. FLARM is designed to receive and process signals from up to 50 aircraft within range. A high number of FLARM units within range has no effect on range.

The transmitter has ***no effect*** on what the receiver in the other aircraft does with the data. It is possible that this data may be captured and stored by other aircraft, or by ground stations, or used for other purposes. This opens up a range of possibilities, some of which may be in the pilot's own interest, (e.g. automated generation of an sailplane launch logging system, aircraft tracking, last position recovery), while others may not be (e.g. detecting tailing of other aircraft, airspace infringements, failure to take avoiding action prior to a collision). When FLARM makes a transmission, the signal also bears a unique identification code that can trace to the pilot or aircraft registration. The user can - even though this is not recommended - configure the unit so that identification is generated randomly and alters at one-minute intervals, making a back-trace difficult.

Operation of FLARM is limited to non-commercial day VFR flights. FLARM may not be used for navigational purposes or aerobatics.

At present FLARM has not been certified or tested in line with the usual aviation procedures (e.g. DO-160E). The FLARM software development is *roughly* in-line with Level E of DO-178B; i.e. a partial or total failure of FLARM will have no effect upon the safe operation of the aircraft, nor does it increase crew workload.

Operation of FLARM is forbidden in the USA or Canada or in aircraft registered in the USA or Canada.

The association FLARM Technology, FLARM Technology GmbH, its associates, owners, staff, management, development team, suppliers, manufacturers and data suppliers accept no responsibility for any damage or claims that may arise from use of FLARM.

USER MANUAL

LX90xx

LX80xx

GPS-Navigation System with Variometer

Version 9.x



1	Important Notices	8
1.1	Limited Warranty	8
1.2	Sunburned Display Warranty	9
2	Basics	10
2.1	The LX90xx/LX80xx Series at a Glance	10
2.1.1	Display Unit Features	11
2.1.1.1	Touch screen	11
2.1.3	V8 Vario Unit Features	12
2.1.4	V80 Vario Unit Features	12
2.1.5	V9 Vario Unit Features	13
2.1.6	Interfaces	13
2.1.7	Internal Options	13
2.1.8	External Options	14
2.1.9	Simulator	15
2.1.10	Technical Data	16
2.1.10.1	Environmental limitations	16
2.1.10.2	LX9000 System	16
2.1.10.3	LX9050 System	16
2.1.10.4	LX9070 System	16
2.1.10.5	LX8040 System	17
2.1.10.6	LX8030 System	17
2.1.10.7	LX8000 System	17
2.1.10.8	LX8080 System	18
2.1.11	Weight	18
3	Packing Lists	19
3.1	LX90xx with FLARM Option	19
3.2	LX90xx	19
3.3	LX90xxD	19
3.4	LX80xx with FLARM Option	19
3.5	LX80xx	20
3.6	LX80xxD	20
4	System Description	21
4.1	Rotary Switches and Buttons	21
4.1.1	Landscape Orientation	21
4.1.2	Portrait Orientation	24
4.1.3	Buttons	24
4.1.3.1	Power Button	24
4.1.4	Rotary Switches (Knobs)	24
4.1.5	Use of Touch Screen	25
4.2	Switching on the Unit	25
4.3	User Input	25
4.3.1	Text Edit Control	26
4.3.2	Masked Text Edit Control	26
4.3.3	Spin Control	27
4.3.4	Selection Control	27
4.3.5	Checkbox and Checkbox List	27
4.3.6	Colour Selector	27
4.3.7	Font Selector	28
4.3.8	Line Pattern Selector	28
4.3.9	Pull Down Menu	29
4.4	Switching off	29
5	Operating Modes	31
5.1	Setup Mode	33

5.1.1	QNH and RES	34
5.1.1.1	QNH*	34
5.1.1.2	Safety Altitude	34
5.1.1.3	Safety Mc versus Mc-offset	34
5.1.1.4	Altitude Source	36
5.1.1.5	Magnetic Variation	36
5.1.1.6	ETA/ETE Calculation	36
5.1.1.7	Soaring Start*	37
5.1.2	Flight Recorder	37
5.1.3	Weight and Balance	38
5.1.4	Vario Parameters*	39
5.1.5	Display	40
5.1.6	Files and Transfers	41
5.1.6.1	Uploading User Airspace and Waypoints by using LOAD button	41
5.1.6.2	Uploading Airspace and Airports Database (ASAPT)	42
5.1.6.3	Downloading and uploading via storage service	42
5.1.6.4	Airspace and NOTAMs	43
5.1.6.5	Airports	46
5.1.6.6	Waypoints and Tasks	47
5.1.6.7	Maps	48
5.1.6.8	Flights	52
5.1.6.9	Flights Declaration	53
5.1.6.10	Formatting a SD Card	53
5.1.6.11	Update Databases	53
5.1.6.12	PDF Documents	54
5.1.6.13	Checklists	55
5.1.7	Graphics	59
5.1.7.1	Map and Terrain	59
5.1.7.2	Weather	60
5.1.7.3	Airspace and NOTAMs	63
5.1.7.4	Waypoints and Airports	64
5.1.7.5	Glider and Track	66
5.1.7.6	Thermal Mode setup	68
5.1.7.7	Optimization	68
5.1.7.8	Task	69
5.1.7.9	FLARM	70
5.1.7.10	Misc	72
5.1.8	Sounds*	72
5.1.8.1	Audio Settings*	73
5.1.8.2	Voice*	74
5.1.8.3	Alarms*	75
5.1.8.4	Observation Zones	76
5.1.9	Optimization	77
5.1.10	Warnings	78
5.1.10.1	Airspace Warnings	78
5.1.10.2	Altitude Warning	79
5.1.10.3	FLARM Warnings	81
5.1.10.4	Time Alarm Warning	82
5.1.10.5	Gear Warning	82
5.1.10.6	Waypoint Warning	83
5.1.11	Units	83
5.1.12	Hardware*	84
5.1.12.1	Vario Unit Settings – TE Compensation*	84

5.1.12.2	Vario Indicator Setup*	88
5.1.12.3	Indicator I9*	88
5.1.12.4	Indicator I8/I80/V8/V80	90
5.1.12.5	Bridge 232*	99
5.1.12.6	FLARM*	100
5.1.12.7	Compass*	103
5.1.12.8	Rear Seat or Front Seat	107
5.1.12.9	Remote Stick*	108
5.1.12.10	AHRS*	109
5.1.12.11	NMEA Output	110
5.1.12.12	Engine *	111
5.1.12.13	Network*	111
5.1.12.14	Flaps*	113
5.1.12.15	Battery Types*	113
5.1.12.16	Analog Inputs	114
5.1.13	Polar and Glider*	115
5.1.13.1	Glider Polar	117
5.1.13.2	Glider speeds	118
5.1.13.3	Glider dump rates	119
5.1.13.4	Weight and balance setup	120
5.1.14	Profiles and Pilots	122
5.1.14.1	Add/load profile	122
5.1.14.2	LX Styler	125
5.1.14.3	Sync	125
5.1.15	LXNAV Connect	126
5.1.15.1	LXNAV Connect Login	127
5.1.15.2	Services	127
5.1.15.3	Profiles	132
5.1.15.4	LXNAV Connect limitations	133
5.1.15.5	LXNAV Connect SERVICES button	134
5.1.16	Language	135
5.1.17	Passwords	135
5.1.18	Admin Mode	136
5.1.19	About	138
5.1.19.1	Debug report	138
5.2	Information Mode	139
5.2.1	GPS Status Page	139
5.2.2	Position Report	140
5.2.3	Satellite Sky View	140
5.2.4	Network Status	141
5.3	Near Mode	141
5.4	Statistics Mode	143
5.4.1	Logbook	143
5.4.2	Statistics during flight	144
5.4.2.1	General Statistics	145
5.4.2.2	Detailed Task Statistics	146
5.4.2.3	OLC Statistics	146
5.5	Airport Mode	147
5.5.1	Initial Navigation Page	147
5.5.2	Second Navigation Page	148
5.5.3	Third Navigation Page	149
5.5.4	Fourth Navigation Page	149
5.5.5	Fifth Navigation Page	150

5.5.6	Button actions Related Only to the APT Page	150
5.5.6.1	Select an Airport	150
5.6	Waypoint Mode	154
5.6.1	Button Actions Related Only to The WPT Page	154
5.6.1.1	Editing Waypoints	154
5.6.1.2	New Waypoint	155
5.6.1.3	Delete Waypoint	156
5.7	Task Mode	156
5.7.1	Button Actions Related Only to TSK Page	158
5.7.2	Task Edit	158
5.7.2.1	View options	159
5.7.2.2	Starts (Multiple Start Points)	159
5.7.2.3	Zone (Modifying Zones)	160
5.7.2.4	Task Options	161
5.7.3	Saving a Task	162
5.7.4	NEW task (Task Creation)	162
5.7.5	Creating a Task in SEEYOU	164
5.7.6	Loading a Task	165
5.7.6.1	Map Edit Mode	165
5.8	Thermal Mode	166
6	Navigational Page Layout	167
6.1	Edit Page Layout	168
6.2	Button Actions	169
6.2.1.1	MacCready, Ballast and Bugs Settings	171
6.2.1.2	Map Settings	172
6.2.1.3	Wind	176
6.2.1.4	Airspace	177
6.2.1.5	Mark	178
6.2.1.6	Xpdr	179
6.2.1.7	Radio	179
6.2.1.8	Team	180
6.2.1.9	FLARM	180
6.2.1.10	Pan	182
6.2.1.11	Rotate FAI Area	183
6.2.1.12	Layout	183
6.2.1.13	Night	183
6.2.1.14	NOTAM	183
6.3	Creating New Symbol	185
6.3.1	Navboxes	186
6.3.1.1	Detailed Description of NAVBOXES	188
6.3.2	Map and Plane (Plane Symbol)	189
6.3.3	Orientation Symbol	190
6.3.4	Final Glide Symbol	190
6.3.4.1	Final Glide Character Explanation	191
6.3.5	Battery Indicator	192
6.3.6	GPS Indicator	192
6.3.7	Wind Arrow and Thermal Assistant	193
6.3.8	Zoom	194
6.3.9	Side View	194
6.3.10	Picture	194
6.3.11	History	194
6.3.12	FLARM Radar	195
6.3.13	Artificial Horizon	195

6.3.14	Altitude Tape	196
6.3.15	Airspeed Tape	196
6.3.16	Vario Tape	197
6.3.17	Magnetic Roses and HSI	197
6.3.18	Compass Tape	197
6.3.19	Flap Tape®	198
6.3.20	3D Map – Synthetic View	198
6.3.21	Vario Indicator	199
6.3.22	G-Meter	199
6.3.23	Wi-Fi Indicator	199
6.3.24	Wind Profile	200
6.3.25	Thermal Graph	200
6.3.26	Meteogram	201
6.3.27	SC Vario	201
6.3.28	FLARM	201
6.4	Navigational Page Settings	202
7	Glider setup	203
7.1	Weight and balance parameters	203
7.1.1	Weights and arms	203
7.1.2	CG envelope	205
7.2	Glider speeds	206
7.3	Glider dump rates	207
8	HAWK	208
8.1	Introduction	208
8.2	Wind Model	209
8.3	The potential climb rate	211
8.4	The Aerodynamic Model	211
8.5	Dynamic behaviour	215
8.6	HAWK system activation	215
8.7	Setup parameters	215
8.7.1	Netto Vario	215
8.7.2	Vario	215
8.7.3	Relative Vario (Super netto)	215
8.7.4	Levelling AHRS	216
8.7.5	HAWK Parameters	216
8.7.6	Graphical display	216
8.7.7	Audio source	216
8.8	Restarting HAWK	217
8.8.1	Manual restarting	217
8.8.2	Automatic restarting: The "HAWK Watchdog"	217
9	Flying With the System	218
9.1	On the Ground	218
9.1.1	Power-On Procedure	218
9.1.2	Profile Selection	218
9.1.3	Set Elevation and QNH	219
9.1.4	Pre-flight Check	219
9.1.4.1	MacCready, Ballast, Bugs	220
9.1.5	Preparing a Task	220
9.1.5.1	Assigned Area Tasks (AAT)	221
9.2	Flying a Task	223
9.2.1	Starting a Task	223
9.2.1.1	Below Altitude Start Procedure	224
9.2.1.2	Maximum Start Speed and/or Maximum Start Altitude	225

9.2.1.3	Event start procedure	226
9.2.2	Restarting a Task	227
9.2.3	Over Turn Point	227
9.2.4	Entering Assigned Area	228
9.2.5	Moving Point Inside Assigned Area	228
9.2.6	Task Finish	229
9.2.7	Graphical Final Glide Assistants	230
9.3	Procedure After Landing	231
10	Firmware Update	232
10.1	Updating the Main Display Firmware	233
10.1.1	Updating Via Wi-Fi Module	234
10.2	Updating Vario Unit or Vario Indicator	236
10.2.1	Automatic Vario Update	236
10.2.2	Manual Vario Update	237
10.2.3	Manual V8/V80/I8/80 Update	237
11	IGC Barograph Recalibration Procedure	238
12	Software options	239
12.1	AHRS option	239
12.2	HAWK option	239
12.3	Club options	240
13	Hardware options	241
13.1	FLARM / POWER FLARM	241
13.1.1	Installation	241
13.1.2	FLARM Update Procedure	242
13.1.3	Uploading Obstacles	242
13.1.4	FLARM Update Procedure with FlarmTool from PC	243
13.1.5	Uploading Obstacles with FlarmTool From PC	244
13.1.6	Uploading FlarmNet Files	245
13.1.7	Flarm error codes	245
13.2	External FLARM or PowerFLARM	246
13.2.1	Installation	247
13.3	ADS-B update	247
13.4	Rear Seat Device	247
13.4.1	Data Exchange	248
13.5	Remote Control	249
13.5.1	Functions	250
13.5.2	Installation	251
13.6	Compass	251
13.7	Flap Sensor®	252
13.8	Secondary Vario Indicators	252
14	Revision History	253
14.1	END OF LIFE (EOL) devices	254

1 Important Notices

The LXNAV system is designed for VFR use only as an aid to prudent navigation. All information is presented for reference only. Terrain, airports and airspace data are provided only as an aid to situation awareness.

Information in this document is subject to change without notice. LXNAV reserves the right to change or improve their products and to make changes in the content of this material without obligation to notify any person or organisation of such changes or improvements.



A Yellow triangle is shown for parts of the manual which should be read very carefully and are important for operating the system.



Notes with a red triangle describe procedures which are critical and may result in loss of data or any other critical situation.



A bulb icon is shown when a useful hint is provided to the reader.

1.1 Limited Warranty

This LXNAV product is warranted to be free from defects in materials or workmanship for two years from the date of purchase. Within this period, LXNAV will, at its sole discretion, repair or replace any components that fail in normal use. Such repairs or replacement will be made at no charge to the customer for parts and labour, provided that the customer shall be responsible for any transportation cost. This warranty does not cover failures due to abuse, misuse, accident, or unauthorised alterations or repairs. LXNAV Instrument displays damaged by direct or magnified sunlight are not covered under warranty.

THE WARRANTIES AND REMEDIES CONTAINED HEREIN ARE EXCLUSIVE AND IN LIEU OF ALL OTHER WARRANTIES EXPRESSED OR IMPLIED OR STATUTORY, INCLUDING ANY LIABILITY ARISING UNDER ANY WARRANTY OF MERCHANTABILITY OR FITNESS FOR A PARTICULAR PURPOSE, STATUTORY OR OTHERWISE. THIS WARRANTY GIVES YOU SPECIFIC LEGAL RIGHTS, WHICH MAY VARY FROM STATE TO STATE.

IN NO EVENT SHALL LXNAV BE LIABLE FOR ANY INCIDENTAL, SPECIAL, INDIRECT OR CONSEQUENTIAL DAMAGES, WHETHER RESULTING FROM THE USE, MISUSE, OR INABILITY TO USE THIS PRODUCT OR FROM DEFECTS IN THE PRODUCT. Some states do not allow the exclusion of incidental or consequential damages, so the above limitations may not apply to you. LXNAV retains the exclusive right to repair or replace the unit or software, or to offer a full refund of the purchase price, at its sole discretion. SUCH REMEDY SHALL BE YOUR SOLE AND EXCLUSIVE REMEDY FOR ANY BREACH OF WARRANTY.

To obtain warranty service, contact your local LXNAV dealer or contact LXNAV directly.

1.2 Sunburned Display Warranty

Any kind of display including LXNAV instrument display screens can be damaged / burned by strong sunlight magnified by canopies in certain positions. We suggest you to cover your device from the direct sunlight, especially if the canopy is open.

LXNAV Instrument displays damaged by direct or magnified sunlight are not covered under warranty.

June 2023

© 2023 LXNAV. All rights reserved.

2 Basics

2.1 The LX90xx/LX80xx Series at a Glance

The system consists of two units: the main display unit and the vario unit. Within the main display unit an integral 50-channel GPS receiver and a high brightness colour display are fitted. An integrated SD card or USB interface is used for user friendly data exchange. Some of the models also feature a PDA port for easy connection to an external PDA device. The main display unit is equipped with a built-in flight recorder according to the most recent IGC specification for all flights. Optionally the FLARM collision avoidance system can be integrated into the main display unit.

Main display unit comes in different forms:

- **LX8080** model with 2.8" screen and 320x240 pixels resolution,
- **LX8000** model with 3.5" screen and 320x240 pixels resolution,
- **LX8040** model with 4.0" screen and 480x480 pixels resolution,
- **LX8030** model with 4.0" screen and 480x480 pixels resolution,
- **LX9050** model with 5.0" screen and 800x480 pixels resolution,
- **LX9000** model with 5.6" screen and 640x480 pixels resolution,
- **LX9070** model with 7.0" screen and 800x480 pixels resolution.

A standard part of system is also the V8 vario unit. It is a most modern Variometer running on a very powerful processor with inertial platform using 3 axis accelerometers, 4 gyroscopes (for inertial vario, AHRS and wind calculation), smooth audio output with audio equalizer and integrated synthesized speech output. The unit communicates with the main display unit via the RS485 system bus. The V8 vario features a 57 mm diameter (2¼") colour screen and three additional buttons.



Generation 4 devices and onwards with V8 or V80 vario are also capable of running [HAWK](#) system, which provides pilot a real-time three-dimensional wind. You can learn more about [HAWK](#) in chapter 8.

Optional vario units are available:

- V80 vario with an 80 mm diameter (3") colour screen and three additional buttons
- V9 vario with a 57 mm diameter (2¼") indicator with mechanical needle and colour display for additional data.

Optionally additional vario indicators and a wide range of interface devices can be daisy-chained using the RS485 bus.

2.1.1 Display Unit Features



Extremely bright colour displays readable in all sunlight conditions with backlight automatically adapted using an ambient light sensor (ALS).

- Using Linux operating system (not CE Windows) ensures fast and stable operation of the firmware.
- 6 or 8 push buttons and 4 rotary switches (knobs) are used for input, which comprise the well-known LX user interface. Optionally a remote stick is available for more comfort.
- Portrait or landscape orientation (portrait orientation is not available on LX80xx models).
- Pre-loaded with worldwide terrain maps, airspace and airport databases.
- Unlimited number of waypoints.
- Unlimited number of tasks (with assigned area support).
- Comprehensive flight and task statistics.
- Display of nearest airports and out-landing fields.
- Unlimited number of pilots/profiles.
- Integrated flight recorder according to high-level IGC specification.
- Real-time flight optimisation according to FAI and OLC rules.
- Flights stored in IGC format are downloadable using the integrated SD Card.
- Flight recorder functions include an integral pressure transducer based on 1013 mbar level for altitude recording, engine noise level sensor, memory to store more than 1000 hours of flights and digital and mechanical security devices to ensure a high level of security.
- Integrated FLARM collision avoidance system with graphic, sound and voice (optional) presentation.

2.1.1.1 Touch screen

LX9050, LX9000 and LX9070 devices have a possibility to have a Touch screen module. It is a multitouch module, which is very useful when configuring device, planning a task, exploring an airspace or panning around while flying.

Touch screen module is not included. Therefore, it needs to be specified when ordering a LX90xx device.

2.1.3 V8 Vario Unit Features



- 2.5" QVGA sunlight readable screen with 1200nits.
- QVGA (320*240pixels) sunlight readable display.
- ARM Cortex-M4 processor running on 160MHz.
- Digital temperature compensated pressure sensors for altitude and airspeed.
- Inertial platform 3 axis digital +-6g accelerometer, 4 gyroscopes (for inertial vario, AHRS and wind calculation).
- Smooth audio output with audio equalizer and many custom audio settings.
- Integrated synthesized speech output.
- Audible thermal assistant.
- External SD card for configuration and firmware update.
- Push buttons for setting adjustments.
- ALS (ambient light sensor).
- Additional Flarm radar screen and artificial horizon (optional).
- Three buttons for toggling between screen and target selection.
- Digital temperature compensated pressure sensors for altitude and airspeed.
- 100Hz sampling rate for very fast response.
- Speed to fly indication.

TE compensation can be selected to be either pneumatic TE probe or digital compensation.

2.1.4 V80 Vario Unit Features



- 3.5" (8.8 cm) sunlight readable screen with 1200nits.
- QVGA (320*240pixels) sunlight readable display.
- ARM Cortex-M4 processor running on 160MHz.
- Digital temperature compensated pressure sensors for altitude and airspeed
- inertial platform 3 axis digital +-6g accelerometer, 4 gyroscopes (for inertial vario, AHRS and wind calculation).
- Smooth audio output with audio equalizer and many custom audio settings.
- Integrated synthesized speech output.
- Audible thermal assistant.
- External SD card for configuration and firmware update.
- Push buttons for setting adjustments.
- ALS (ambient light sensor).

- Additional Flarm radar screen and artificial horizon (optional).
- Three buttons for toggling between screen and target selection.
- Digital temperature compensated pressure sensors for altitude and airspeed.
- 100Hz sampling rate for very fast response.
- Speed to fly indication.

TE compensation can be selected to be either pneumatic TE probe or digital compensation.

2.1.5 V9 Vario Unit Features



- ARM Cortex-M4 processor running on 160MHz.
- Mechanical needle driven by stepper motor.
- QVGA (320*240pixels) sunlight readable display
- Digital temperature compensated pressure sensors for altitude and airspeed
- Inertial platform 3 axis digital +-6g accelerometer, 3 axis gyroscopes (for inertial vario, AHRS and wind calculation)
- Smooth audio output
- Audio equalizer
- Integrated synthesized speech output.
- Audible thermal assistant
- 6 digital inputs - SC, VP + 4 custom defined
- Multilanguage user interface.

2.1.6 Interfaces

- The RS232 interface has NMEA output for external devices.
- An SD Card interface.
- A USB slot for data transfer using USB memory stick.

2.1.7 Internal Options

A **FLARM module** can be built into the main display unit. All necessary connectors are available on the rear side of the unit (FLARM external indicator, FLARM antenna), which guaranties the same comfort as with the original FLARM devices. It is very important to point out that the whole system uses only one GPS receiver and therefore offers a low power solution.

An **Artificial horizon** can be enabled on main display unit. The Vario sensor box is constantly using data from the inertial platform in order to make the vario signal smoother, however if pilot would like to see the artificial horizon an additional software option to do so must be purchased.

2.1.8 External Options

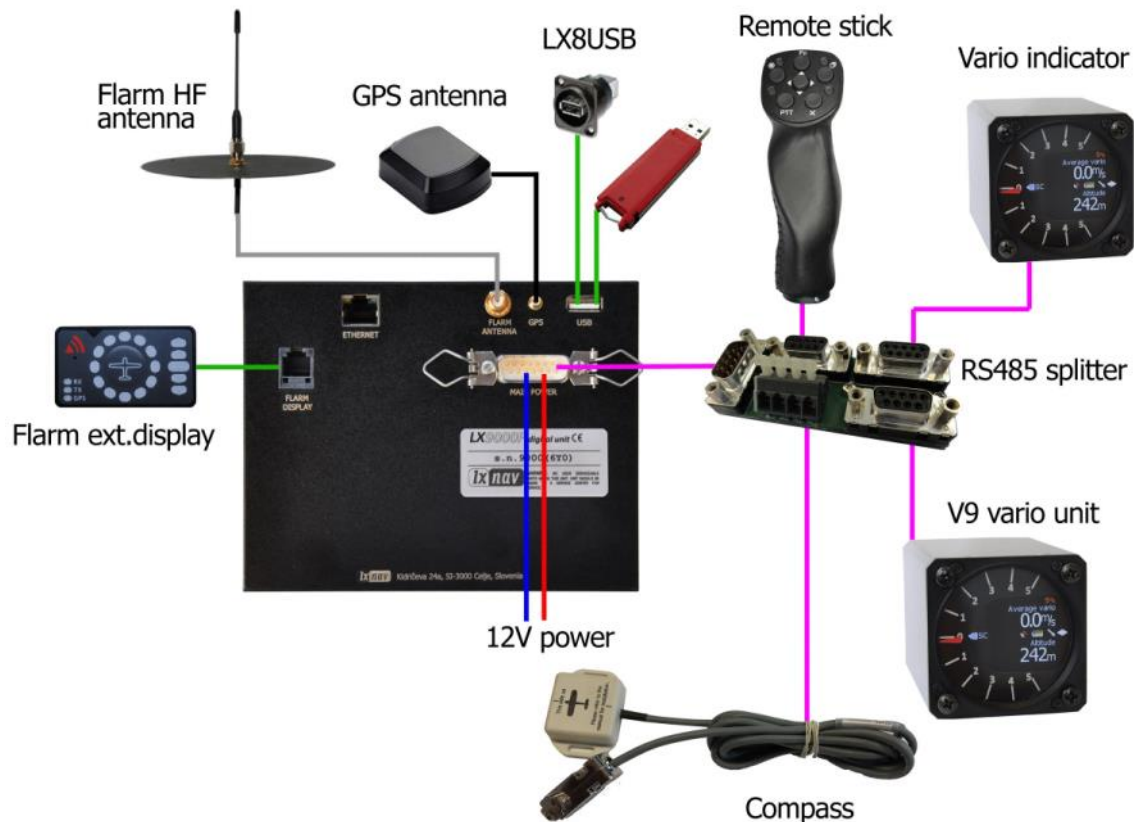

By using a RS485 bus system a wide range of optional interfaces can be easily connected to the basic configuration with minimal installation work. The LXNAV bus system can be extended easily by use of RS485 splitting units, which allow plug and play connection of optional devices.

The following units can be connected to the main system:

- **Second Seat Device (LX9000D, LX9050D LX9070D LX8000D or LX8080D):** The unit installed in the rear seat of the glider is powered and receives all necessary data from the main unit. The communication between both units is exclusively via the RS485 bus system.
- **Remote Control:** An extremely ergonomic leather-coated handle which includes 8 push buttons to operate the main display unit and two additional buttons with open wires. These two buttons can be used for instance as PTT for radio and SC/Vario changeover command. A second remote control can be installed to control the second seat device or for side-by-side operation.
- **Electrical Compass Device**
- **Secondary Vario Indicators (I8, I9 or I80 indicator)**
- **Flap sensor**
- **MOP box** for jet engines
- **232 Bridge** for radio or transponder
- **Wi-fi module**
- **External FLARM module**
- **Touch option**

2.1.9 Simulator

There are two options to stay in condition and familiar with your system. LXSim is a free of charge program, which you can download from www.lxnav.com or data from the Condor PC flight simulator (www.condorsoaring.com) can be received via the RS232 port after entering suitable passwords (see Chapter 5.1.17).

For connection of the device with Condor flight simulator you can use any RS232 to USB cable. In your LX80xx/90xx device enter the password "555556", as described above and make sure the baud rate is set to the same number (9600) on your PC and on your LX80xx/90xx.

These features are extremely useful for pilots who want to learn about the system and also wish to refresh their knowledge after a winter break. Please note that altitude data will be sent from the simulator which means that real final glide training will be possible.

2.1.10 Technical Data

2.1.10.1 Environmental limitations

- Operating temperature: -20°C to +70°C
- Storage temperature: -30°C to +85°C
- Relative humidity: 0%-95%
- Vibration: +/- 50m/s² at 500Hz

2.1.10.2 LX9000 System

- Power input 10-16 V DC.
- Consumption at 12 V:
 - 250 mA - minimum brightness without audio and options.
 - 260 mA - minimum brightness without audio and with FLARM.
 - 470 mA - maximum brightness without audio and options.
 - 480 mA - maximum brightness without audio and with FLARM.
 - 160 mA – additional for a V8 vario unit.
- Cut-out dimensions of the LX9000 display unit are 109 x 143 mm; outline dimensions: 113 x 145 x 38 mm exclusive connector.
- 57 mm (2¼") standard aircraft cut-out for the V9 vario unit; length 92 mm (exclusive connector).
- 57 mm (2¼") standard aircraft cut-out for the V8 vario unit; length 95 mm (exclusive connector).
- 80 mm (3") standard aircraft cut-out for the V80 vario unit; length 130 mm (exclusive connector).

2.1.10.3 LX9050 System

- Power input 10-16 V DC.
- Consumption at 12 V:
 - 250 mA - minimum brightness without audio and options.
 - 260 mA - minimum brightness without audio and with FLARM.
 - 470 mA - maximum brightness without audio and options.
 - 480 mA - maximum brightness without audio and with FLARM.
 - 160 mA – additional for a V8 vario unit.
- Cut-out dimensions of the LX9050 display unit are 134 x 79 mm; outline dimensions: 136 x 83 x 61 mm exclusive connector.
- 57 mm (2¼") standard aircraft cut-out for the V9 vario unit; length 92 mm (exclusive connector).
- 57 mm (2¼") standard aircraft cut-out for the V8 vario unit; length 95 mm (exclusive connector).
- 80 mm (3") standard aircraft cut-out for the V80 vario unit; length 130 mm (exclusive connector).

2.1.10.4 LX9070 System

- Power input 10-16 V DC.
- Consumption at 12 V:
 - 250 mA - minimum brightness without audio and options.
 - 260 mA - minimum brightness without audio and with FLARM.
 - 470 mA - maximum brightness without audio and options.
 - 480 mA - maximum brightness without audio and with FLARM.
 - 160 mA – additional for a V8 vario unit.
- Cut-out dimensions of the LX9070 display unit are 109 x 179 mm; outline dimensions: 113 x 181 x 38 mm exclusive connector.

- 57 mm (2¼") standard aircraft cut-out for the V9 vario unit; length 92 mm (exclusive connector).
- 57 mm (2¼") standard aircraft cut-out for the V8 vario unit; length 95 mm (exclusive connector).
- 80 mm (3") standard aircraft cut-out for the V80 vario unit; length 130 mm (exclusive connector).

2.1.10.5 LX8040 System

- Power input 10-16 V DC.
- Consumption at 12 V:
 - 270 mA - minimum brightness without audio and options.
 - 330 mA - minimum brightness without audio and with Power FLARM.
 - 380 mA - maximum brightness without audio and options.
 - 410 mA - maximum brightness without audio and with Power FLARM.
 - 160 mA – additional for a V8 vario unit
- Cut-out dimensions of the LX8040 digital unit are 79,8 x 78,8 mm; outline dimensions: 81,2 x 81,2 x 77 mm exclusive connector.
- 57 mm (2¼") standard aircraft cut-out for the V9 vario unit; length 92 mm (exclusive connector).
- 57 mm (2¼") standard aircraft cut-out for the V8 vario unit; length 95 mm (exclusive connector).
- 80 mm (3") standard aircraft cut-out for the V80 vario unit; length 130 mm (exclusive connector).

2.1.10.6 LX8030 System

- Power input 10-16 V DC.
- Consumption at 12 V:
 - 270 mA - minimum brightness without audio and options.
 - 330 mA - minimum brightness without audio and with Power FLARM.
 - 380 mA - maximum brightness without audio and options.
 - 410 mA - maximum brightness without audio and with Power FLARM.
 - 160 mA – additional for a V8 vario unit
- Cut-out dimension of the LX8030 digital unit is 80 mm (3") standard aircraft cut-out; outline dimensions are 81mm x 81mm x 77mm exclusive connector.
- 57 mm (2¼") standard aircraft cut-out for the V9 vario unit; length 92 mm (exclusive connector).
- 57 mm (2¼") standard aircraft cut-out for the V8 vario unit; length 95 mm (exclusive connector).
- 80 mm (3") standard aircraft cut-out for the V80 vario unit; length 130 mm (exclusive connector).

2.1.10.7 LX8000 System

- Power input 10-16 V DC.
- Consumption at 12 V:
 - 290 mA - minimum brightness without audio and options.
 - 300 mA - minimum brightness without audio and with FLARM.
 - 380 mA - maximum brightness without audio and options.
 - 390 mA - maximum brightness without audio and with FLARM.
 - 160 mA – additional for a V8 vario unit
- Cut-out dimensions of the LX8000 digital unit are 93.5 x 81.5 mm; outline dimensions: 98 x 88 x 115 mm exclusive connector.
- 57 mm (2¼") standard aircraft cut-out for the V9 vario unit; length 92 mm (exclusive connector).

- 57 mm (2¼") standard aircraft cut-out for the V8 vario unit; length 95 mm (exclusive connector).
- 80 mm (3") standard aircraft cut-out for the V80 vario unit; length 130 mm (exclusive connector).

2.1.10.8 LX8080 System

- Power input 10-16 V DC.
- Consumption at 12 V:
 - 160mA at 50% LCD brightness (600nits still readable under sunlight).
 - 260mA with integrated FLARM at 100% LCD brightness (1200nits).
 - 160 mA – additional for a V8 vario unit.
- Cut-out dimension of the LX8080 digital unit is 80 mm (3") standard aircraft cut-out; outline dimensions are 81mm x 81mm x 65mm exclusive connector.
- 57 mm (2¼") standard aircraft cut-out for the V9 vario unit; length 92 mm (exclusive connector).
- 57 mm (2¼") standard aircraft cut-out for the V8 vario unit; length 95 mm (exclusive connector).
- 80 mm (3") standard aircraft cut-out for the V80 vario unit; length 130 mm (exclusive connector).

2.1.11 Weight

- LX9000 display unit: 650 g
- LX9050 display unit: 515 g
- LX9070 display unit: 650 g
- LX8040 digital unit: 460 g
- LX8030 digital unit: 472 g
- LX8000 digital unit: 580 g
- LX8080 digital unit: 400 g
- V8 vario unit: 300 g

3 Packing Lists

3.1 LX90xx with FLARM Option

- LX9000, LX9050 or LX9070 main display unit
- V8 vario unit (optional V80 or V9)
- Main power cable for main display unit
- Cable for vario unit
- SD card
- Barogram calibration chart
- GPS antenna
- FLARM Antenna
- Hex key "Inbus"
- USB key containing the digital version of the Manual.

3.2 LX90xx

- LX9000, LX9050 or LX9070 main display unit
- V8 vario unit (optional V80 or V9)
- Main power cable for main display unit
- Cable for vario unit
- SD card
- Barograph calibration chart
- GPS antenna
- Hex key "Inbus"
- USB key containing the digital version of the Manual.

3.3 LX90xxD

- LX9000D or LX9050 or LX9070D
- Main power cable
- RS485 cable – 4 meters
- RS485 splitting unit
- Vario indicator I8 (Optional I80 or I9)
- SD card
- Hex key "Inbus".

3.4 LX80xx with FLARM Option

- LX8000 or LX8080 main display unit
- V8 vario unit (optional V80 or V9)
- Main power cable for main display unit
- Cable for vario unit
- SD card (Not included with LX8030&LX8040)
- Barogram calibration chart
- GPS antenna
- FLARM Antenna
- Wi-Fi Antenna (LX8030&LX8040 only)
- Hex key "Inbus"
- USB key containing the digital version of the Manual.

3.5 LX80xx

- LX8000 or LX9080 main display unit
- V8 vario unit (optional V80 or V9)
- Main power cable for main display unit
- Cable for vario unit
- SD card (Not included with LX8030&LX8040)
- Barograph calibration chart
- GPS antenna
- Wi-Fi Antenna (LX8030&LX8040 only)
- Hex key "Inbus"
- USB key containing the digital version of the Manual.

3.6 LX80xxD

- LX8000D or LX8080
- Main power cable
- RS485 cable – 4 meters
- RS485 splitting unit
- Vario indicator I8 (Optional I80 or I9)
- SD card (Not included with LX8030&LX8040)
- Hex key "Inbus".

4 System Description

The main display unit of the LX90xx series can be mounted with portrait or landscape orientation. After installing the main display unit, the orientation must be defined via the Display menu (see Chapter 0).

The main display unit of the LX80xx series can be mounted only in landscape mode.



In this manual all screenshots are given for portrait orientation of the LX9000 system, which is most commonly used. However, all functionality is the same in any other configuration of system. Small differences are marked further in the manual.

4.1 Rotary Switches and Buttons

The following controls are mounted on the front face of the main display unit:

- Four rotary selector knobs
- Eight (lx90xx) or six (lx80xx) push-buttons
- SD card reader

4.1.1 Landscape Orientation







4.1.2 Portrait Orientation



The V9 vario unit is an indicator only and has no controls. Information displayed is controlled by the main display unit.



The V80/V8 vario unit has three buttons to toggle between screens. More information is given in Chapter 5.1.12.4.

4.1.3 Buttons

All buttons have a dynamic function; the first time one presses each button it displays its function without executing any action. Not all buttons have a function on every page. In some cases, buttons have a long press function.

4.1.3.1 Power Button

The power button is marked with the ON/OFF symbol. It has multiple functions. Primarily it is used to switch the system on and off.

4.1.4 Rotary Switches (Knobs)

The main display unit has four rotary knobs. Each has a single function with the exception of the zoom knob which has, in some cases, a function other than zoom. With the upper-left rotary knob the volume can be adjusted. The upper-right rotary switch is the mode selector (it changes the mode of the operation). At the lower-right is the up/down knob which is used for selecting sub-pages, sub-menus and editing menus. At the lower-left is the zoom knob which is multifunctional. While its main function is to change the zoom level within graphic mode, it can also be used if an error is made during editing; it is possible to move the cursor back by rotating this knob. However, this can only be done if 'editing' is active which is shown by the cursor blinking.

4.1.5 Use of Touch Screen

A touch screen is a great option that lets you use your finger instead of rotary switches and push buttons to navigate a device's operating system. Touch screen is operable as on every smartphone.

Operating with the Touch:

- switching modes: swipe left/right
- switching pages: swipe up/down

Zooming can be done if you touch the screen with two fingers and spread them. If you touch the menu item, you will enter into the menu.

4.2 Switching on the Unit

After a short press of the power-on button the main display and vario units will turn on and a welcome screen will appear. The first screen shows the boot loader screen followed by the Linux kernel screen and then the file system screen.



The boot procedure normally takes up to 20 seconds but in the case of a firmware update or system check it can take longer. The final boot screen displays information about the system firmware and the IGC serial number. When the boot procedure is completed the profile selection dialogue is shown. Please refer to Chapter 9.1 for more details about starting up the system.

4.3 User Input

The main display unit user interface consists of many dialogues which have different input controls. They are designed to make input of names, parameters, etc. as easy as possible. Input controls can be summarised as:

- Text editor
- Masked text editor
- Spin controls
- Selection control
- Checkboxes
- Colour selector
- Line width selector

To move the function from one control to another, rotate the PAGE selector knob (page selector) as follows:

- Clockwise rotation will select the next control.
- Counter clockwise rotation will select the previous control. Press the SELECT button (usually lower-right) to enter control input.

4.3.1 Text Edit Control

The Text Editor is used to input an alphanumeric string of arbitrary length; the picture below shows typical options when editing text. Use the bottom-right knob to change the value at the current cursor position.



Press the **CHAR>>** button to advance the cursor to the next position. The cursor can also be moved to next position using the bottom-left knob. Rotate it clockwise to move forward.

The Abc button is a toggle button and will change the letter case. Press it to toggle modes.

- **Abc** mode will start every new word with a capital letter; subsequent letters will be lower case.
- **ABC** mode will enter only upper-case letters.
- **abc** mode will enter only lower-case letters.

Pressing the **DELETE** button will delete the character at current cursor position. Continually press the **DELETE** button to delete all characters after the current cursor position. **INSERT** will insert a character at given position. Use **KBD** button do display and use a keyboard. Keyboard is automatically open, when using touch screen. Press **OK** to confirm changes and leave control. Press **CANCEL** to abandon changes and revert back to the values before entering this screen.

4.3.2 Masked Text Edit Control

The masked editor is a similar control to the text editor but only limited characters can be entered at any particular position. It is designed to enter latitude, longitude and passwords.

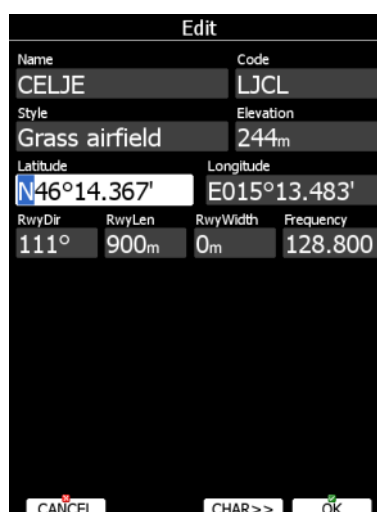

4.3.3 Spin Control

Spin controls are designed for numeric parameters. Rotate the bottom-right knob (page selector) to increase/decrease the selected value. The bottom-left (zoom) knob will increase/decrease the value with a different step compared to the page selector.



4.3.4 Selection Control

Selection boxes, also known as combo boxes on the Windows operating system, are used to select a value from list of predefined values. Use the page selector to scroll through the list.

4.3.5 Checkbox and Checkbox List

A checkbox enables or disables a particular parameter. Press **SELECT** to toggle the value. If an option is enabled a check mark will be shown, otherwise an empty rectangle will be displayed.

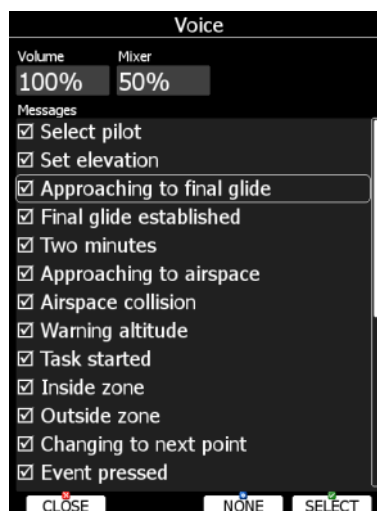

Use page selector to scroll through the checkbox list. Press the **ALL** to enable all options.

4.3.6 Colour Selector

Colours and fills are set via the colour selector control. Rotate the page selector to change a colour.

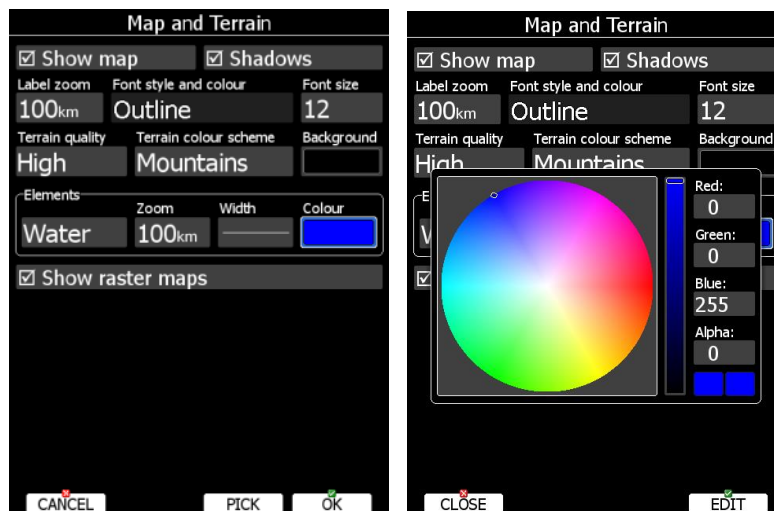

Rotating the zoom selector changes colour transparency. Transparency is very important for fill colours which are used for airspace zones, observation zones and FAI area. If a fill colour is not transparent (0%), all other map items will not be seen through it. If a fill colour is 100% only the solid border will be drawn.

Press the PICK button to define colour more precisely. A colour dialogue will open, where you can select a colour from the HSV circle or enter values for red, green and blue colour.

4.3.7 Font Selector

Using the font selector, it is possible to define a font colour and style for a selected item.



Turn the PAGE selector knob (page-selector) to change the font style. Text is also rendered in the selected font style. Turn the ZOOM selector knob (zoom-selector) to change the font colour.

Press the PICK button to define colour more precisely. A colour dialog will open, where you can select a colour from the HSV circle or enter values for red, green and blue.

4.3.8 Line Pattern Selector

Using the line pattern selector, it is possible to define width and pattern of a line. Turn the PAGE selector knob (page-selector) to change the width of line. Turn the ZOOM selector knob (zoom-selector) to change the line pattern. Results are immediately visible on the selected item.

4.3.9 Pull Down Menu



A pull-down menu is used to select one of the options. Press the button several times to select appropriate item of turn PAGE selector knob. Pull down menu will automatically close after few seconds.

4.4 Switching off

Please use one of the following recommended methods for shutting down the LX90xx system:

Method 1

Press the button with the **OFF** label which is displayed in navigational modes. See Chapter 5.5 for more details. A message to confirm shutdown will be shown.

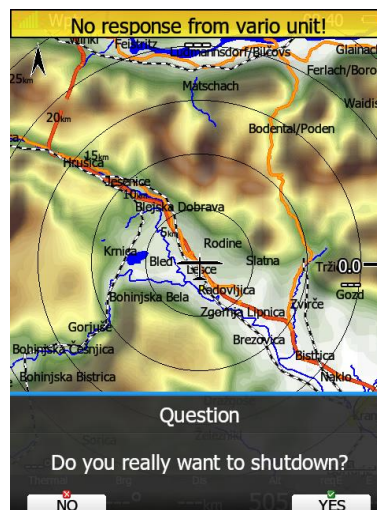

Method 2

Press the button with the **OFF** symbol for approximately 4 seconds. The OFF message will be displayed, and the instrument will shut down. When the message appears, you must release the power button.

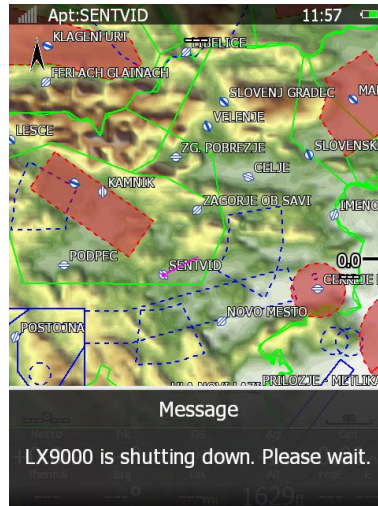

Method 3

When the button with the **OFF** symbol is pressed for more than 8 seconds the system will perform an unconditional shutdown. This method is recommended only in case that the program hangs and it is not possible to shutdown with methods 1 or 2.



If you are using method 2 to switch off the system it is necessary to release the button when you see the shutting down message. If you continue to press the off button the main display unit may shut down by method 3.

If the request for OFF is made during flight the instrument will ask for confirmation so that the system cannot be switched off by mistake.



It is important that the main display unit is switched off via software. Never power down the system using the main power switch. The main display unit is running the Linux operating system and sudden power loss may corrupt the file system.



If main power is lost for a few seconds during flight the flight recorder will not produce two flights. The most important flight parameter (altitude) will remain which means that the final glide calculations are not affected.

5 Operating Modes

The main display unit has seven **modes** or **main menus**. All of them are selectable by rotating the upper-right knob which is also known as the **MODE selector**. The diagram below shows the mode structure of the LX9000 running in portrait screen.

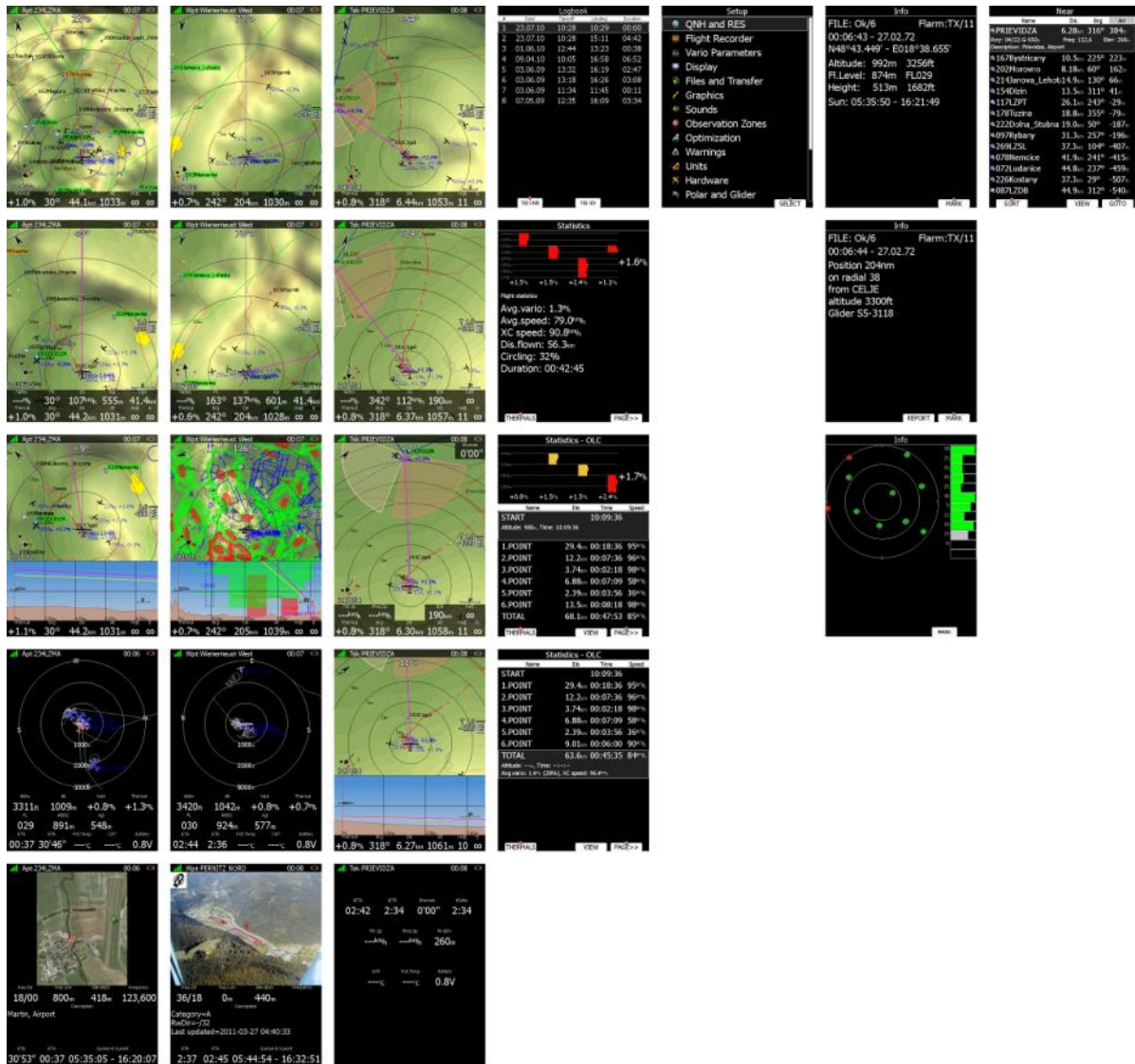

- **Airport Mode**, navigation to and selection of airports.
- **Waypoint Mode**, navigation, selection and editing waypoints.
- **Task Mode**, Navigation, selection and editing tasks.
- **Statistics Mode** shows statistical data for flight in progress or the logbook.
- **Setup** mode is used to configure the whole system.
- **Information Mode** displays GPS status, altitude, flight level and height, sunrise and sunset or position report to selectable point or satellite sky view (only if there is no internal FLARM).
- **Near Mode** displays a list of all landable waypoints and airports.

The Navigation modes and statistics mode have additional pages which are accessible by rotating the bottom-right knob also called the **PAGE selector**.

Three main navigational modes **airport**, **waypoint** and **task mode** are selected by rotating the upper-right knob. All three options are similar and have similar basic navigation data screens accessed by rotating the bottom-right knob.



It is possible to fully customise all three main navigational pages using the program LXStyler. This program can be downloaded from our webpage www.lxnav.com.



It is also possible to customise selected navigational pages using the STYLE menu option. Refer to Chapter 6 for more details.

In airport navigation mode the user can navigate only to airports stored in LXNAV's Airports database. This database cannot be edited on the device itself and is available at no charge on our web pages. See Chapter 5.1.6.2 for more details how to obtain the latest databases.



The database can be modified using program LXAsapt editor. This program can be downloaded from our webpage www.lxnav.com

In waypoint navigation mode the user navigates to waypoints that were previously loaded and selected in the **Files and Transfer** menu (see Chapter 5.1.6.5).

Task navigation mode is used for task creation and manipulation. Navigation in this page is exclusively to task points.

5.1 Setup Mode

In the setup menu users can configure the main display unit and connected devices. Turn the bottom-right knob - PAGE selector - or press the UP/DOWN arrow on the remote stick to select the appropriate setup item. Turn the bottom-left knob - ZOOM selector - or press the LEFT/RIGHT arrow on the remote stick to move faster over the menu. Press the **SELECT** button or push the middle multi-directional button on the remote stick to enter a menu. A dialogue or sub-menu will open.

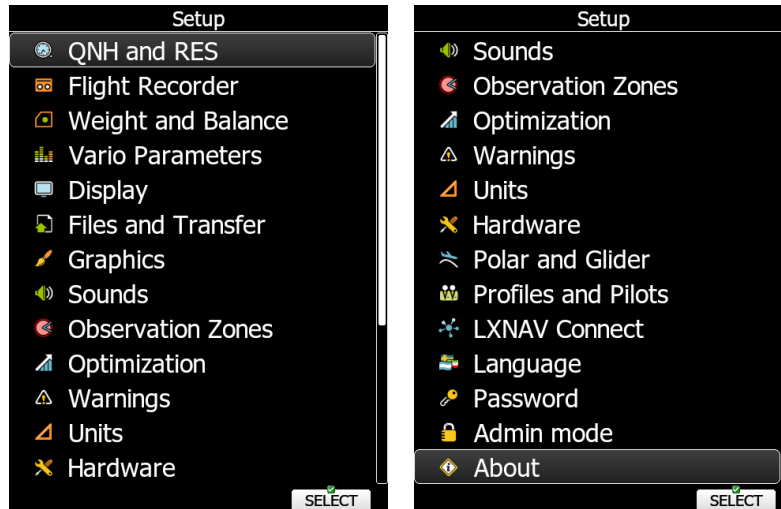

For touch screen it will be same content, however slightly different.

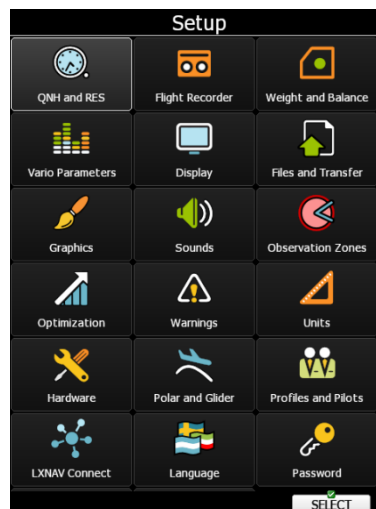

The setup menu is slightly different on the rear seat device as not all options are applicable.



Items which are marked with an asterisk (*) are available only in the front seat setup menu.

5.1.1 QNH and RES

Turn the bottom-right knob to select the required entry field. Press the **EDIT** button and start editing the value.

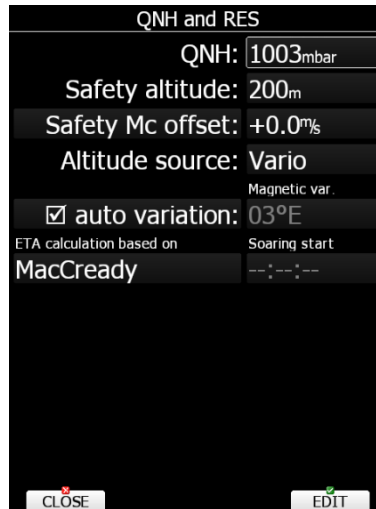

5.1.1.1 QNH*

Using this feature, it is possible to offset the altitude datum which could have changed due to pressure changes during the flight. Since changing the QNH influences the indicated altitude, care should be taken when changing the value as an incorrect setting can upset the final glide calculation.

5.1.1.2 Safety Altitude

This setting is the altitude reserve or safety altitude and is the height that the instrument adds to the final glide altitude required so that the glider arrives over the final glide destination at the selected safety altitude. Once the safety altitude has been specified, the pilot has to keep the final glide indicator on 0 to arrive at the safety altitude.

5.1.1.3 Safety Mc versus Mc-offset

Main display unit adopts a concept of having different MacCready values for speed to fly and for final glide calculation. Speed to fly MacCready is referred as Mc in document and MacCready for final glide calculation is referred as Safety Mc.

Mc and Safety Mc can be completely decoupled. In this case pilot must separately adjust both values.



Please do not use this function, if you don't fully understand this feature!
Improper use of this functionality may disturb your final glide calculation.
Do not set Mc higher than Safety Mc!

The other option is to define Mc-offset. In this case additional offset is applied to selected MacCready value and this value is used for final glide calculation. To turn Safety Mc offset back off, just turn it down to +0.0.

Safety Mc

When this setting is used, final glide is calculated using independent **Safety Mc** value. This value can be set in this menu or in quick access menu like Mc for speed to fly. All final glide calculations will be calculated by this **Safety Mc** value.



Mc setting has no influence on final glide calculations!

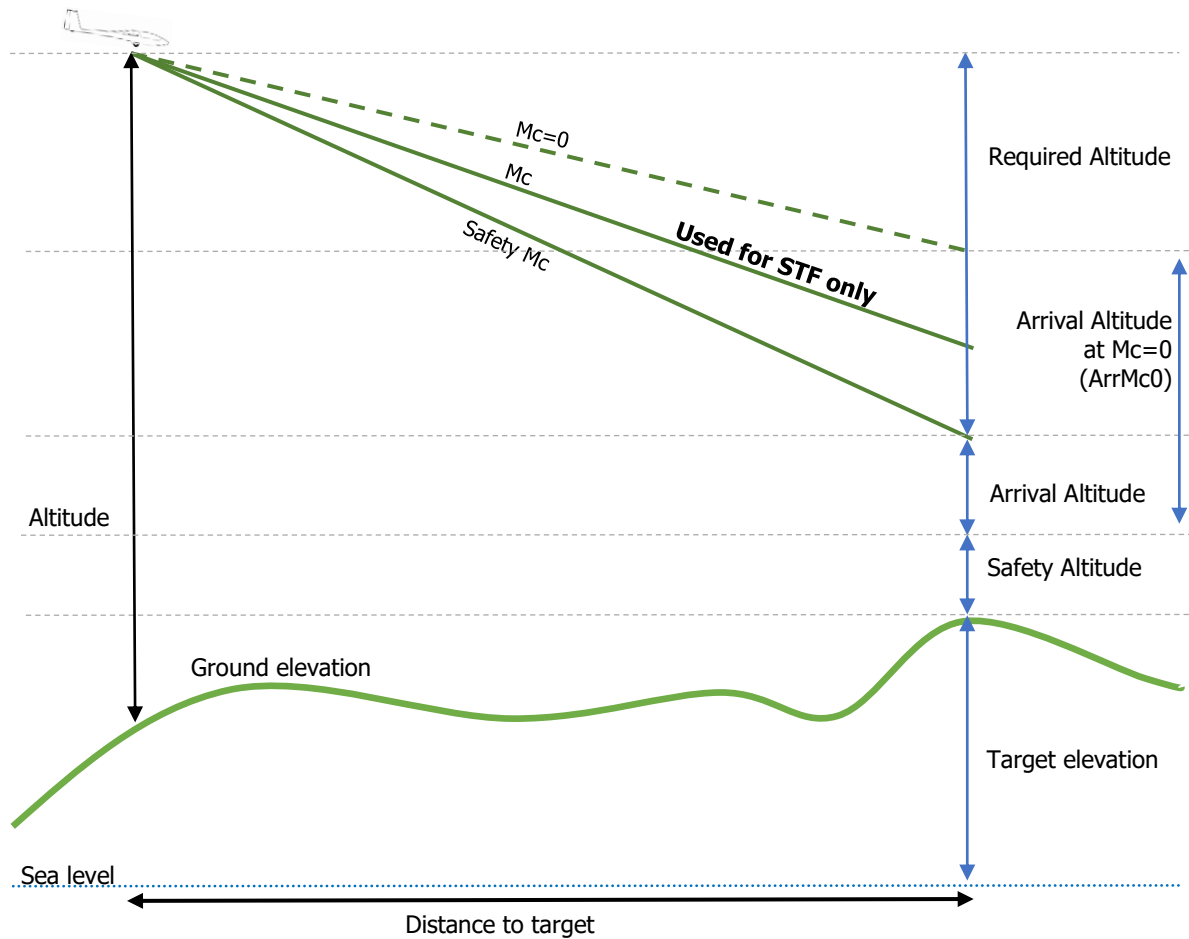

Safety Mc-offset

Sometimes it is convenient to have some additional safety, which depends on distance to target. Therefore, we have introduced Safety Mc-offset. This value is automatically added to your selected MacCready value and then sum of Mc and Mc-offset is used to calculate final glides, whereas speed to fly is calculated by Mc only.

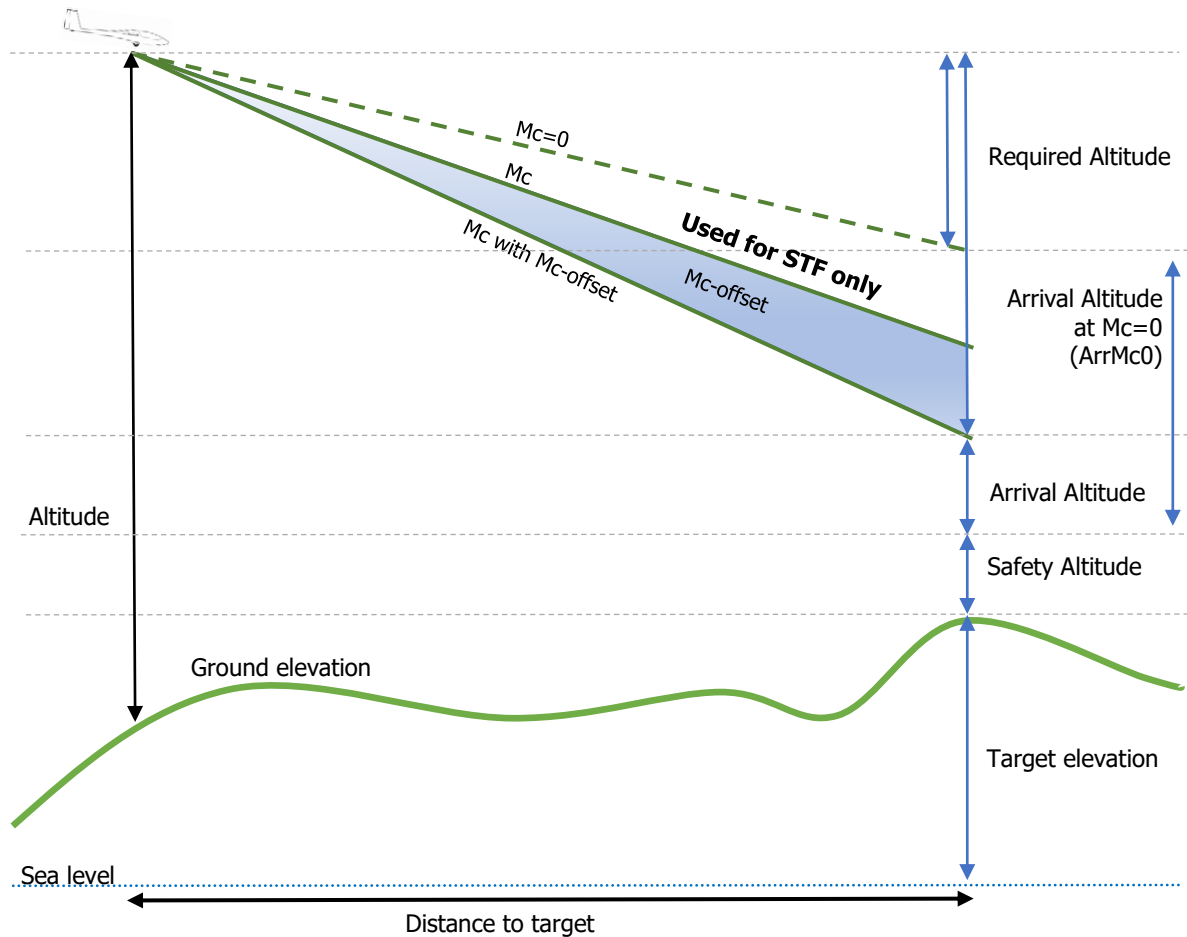

5.1.1.4 Altitude Source

The system has two pressure altitude sensors. One is built into the main display unit and is used for the IGC recorder and the second one is built into the vario unit and is connected to the glider pitot-static system. Changing the altitude source defines which sensor is used for pressure altitude used in program.

5.1.1.5 Magnetic Variation

The main display unit has a built-in Earth magnetic field model. If Auto variation is checked the magnetic variation is derived from this model, otherwise the user can enter a custom value.

5.1.1.6 ETA/ETE Calculation

In changing this value, you may choose from four different methods to calculate the estimated time of arrival to the navigational point. Calculation is always divided into straight flight and climb time calculations.

- **MacCready** uses the Polar data and MacCready setting to calculate speed to fly and climb rate.
- **Vario** uses the last four thermals average to compute climb rate and uses this value to calculate speed to fly.
- **Avg.Speed & Vario** uses the average ground speed over the last 5 minutes for distance and Vario statistics for climb rate.
- **Avg.Speed & MC** uses the average ground speed over the last 5 minutes for distance and MacCready.

All four methods of calculating ETA and ETE (Estimate Time of Arrival & Estimate Time Elapsed) take into account glider altitude, wind and safety (arrival) altitude thus ensuring that the calculation made is the best possible.



Suggested methods for competition pilots are **Avg.Speed & Vario** or **Avg.Speed & Mc**.

5.1.1.7 Soaring Start*

Soaring start is the time when the glider starts soaring (released from tow, engine switched off). A soaring start time is needed to start the flight optimization.

5.1.2 Flight Recorder

The main display unit has a built-in flight recorder fully approved by the IGC (a sub-committee of the FAI) and will produce secure flight records that are acceptable for all FAI requirements including world records.

Flight Recorder		
Interval		
12sec		
CN	Reg.Nr.	
EJ	ZS-GEI	
Pilot first name	Surname	Weight
Erazem	Polutnik	95kg
Copilot first name	Copilot surname	Weight
		---kg
<input checked="" type="checkbox"/> log other aircrafts data		
<input checked="" type="checkbox"/> log flap position		
CANCEL OK		

Select the recording interval and enter the pilot name. **Pilot weight is important if ballast is specified in kilograms of water** (see Chapter 5.1.10.5). If the system is used in two-seat aircraft the name of the co-pilot may also be entered.

SWAP button allows you to quickly change the pilot and co-pilot (e.g. when flying in two-seater competitions).



There is no setup for glider type. Glider type is defined in the Polar and Glider setup (see Chapter 5.1.12).



There are very few settings for the flight recorder compared to other instruments. This is because main display unit will record all additional data such as wind, speed and vertical speed by default.

If a new pilot is entered, upon exiting the dialogue the message *"Do you want to create new profile with this pilot?"* will appear. Answer **YES** if you want to quickly add a new profile. For more information about profiles see Chapter 5.1.14.

The user can also enable options to log other aircraft data (FLARM data) and flap position.

5.1.3 Weight and Balance

If all weight and balance parameters are specified for a glider, you can see your CG position in this dialog and optimise water ballast in the tail. Details how to setup weight and balance parameters are given in chapter 5.1.13.4 and chapter 7.



Enter required data, to see, where is your dry CG position and your CG with water ballast. Green dot shows you dry CG position and blue dot shows you wet CG position.



Weight and balance calculations are for informational use only. It does not replace data provided by glider manufacturer. Always consult the aircraft's pilot operating handbook for the official weight and balance data.



You cannot enter the water ballast until you set all other parameters (e.g. empty glider weight). See above chapter 5.1.13.4 and chapter 7 for more information.

5.1.4 Vario Parameters*

This option is used to set the vario parameters.

Vario Parameters		
Vario needle filter	Vario sound filter	Vario range
1.5sec	1.5sec	5m/s
HAWK		
<input checked="" type="checkbox"/> Enabled		
Wind variance	Wind avg. hor.	Wind avg. ver.
0.05	20.0	3.0
SC tab	Integrator time	Auto SC
1.0%	20sec	OFF
Smart vario filter	Beep at max	Beep before max
OFF	OFF	3.0s
<input type="checkbox"/> Auto reset integrator		
Netto filter	SC filter	Relative filter
0.2sec	1.5sec	1.5sec
Netto time		
20sec		
CLOSE		EDIT

Following parameters are set:

Vario needle filter sets a time constant of the vario needle. The value can be adjusted between 0.1 and 5 s with step 1.0 s or 0.1 s. Default value is 1.5 s.

Vario sound filter sets a time constant of the vario sound. The value can be adjusted between 0.1 and 5 s with step 1.0 s or 0.1 s. Default value is 1.5 s.

Vario range sets full scale range of the vario (2.5 m/s, 5 m/s or 10 m/s). Default value is 5 m/s (10 kts).

HAWK enabled, using this checkbox, pilot can switch on/off HAWK system.

HAWK wind variance smooths the horizontal and vertical wind (netto vario) readings. The larger the value of wind variance is, the more nervous the readings. Recommended value for wind variance is 0.11.

HAWK Horizontal wind average defines period, which is used for average horizontal wind calculation, which is displayed as grey arrow on wind page.

HAWK Vertical wind average defines period, which is used for average relative and average netto calculation. Both values can be shown as navbox on numeric or graphic page.

SC tab defines the width of the audio dead band in speed to fly mode. Default value is ± 1 m/s.

Integrator time defines the integration period for the average vario in seconds. The default is 20 seconds.

Auto SC defines the conditions when the instrument is switched automatically between vario and speed command.

- **OFF:** Switching is exclusively by an external switch connected to the vario unit.
- **GPS:** When the GPS detects that the glider is circling an automatic change over to vario will happen after approximately 10 seconds. Detection of straight flight will cause a changeover to speed command.
- **G-load:** When accelerometer detects increased g-load, because of circling, Variometer will change from cruise to climb mode.
- **IAS:** When the IAS exceeds a pre-set value. The IAS at which switching occurs can be selected in 5 km/h steps from 100 up to 160 km/h (or the equivalent in knots or mph).

Using **Smart vario filter** the vertical speed can be further filtered. Smart vario filter defines the maximum speed of the vario needle. The higher the value is, the slower the needle will be.

Beep at max will enable a short beep before a maximum in thermal is reached. Short beep can be setup based on angle of seconds before reaching maximum

Beep before max defines how many seconds or at what angle before a maximum in thermal a short beep will be heard.



The external switch wired to the vario unit has absolute priority and will override all other switching methods.

Auto reset integrator resets the integrator to zero when the vario unit switches from cruise to climb mode. If this item is not checked the integrator will not be reset to zero.

Netto filter sets a time constant of the netto vertical speed filter. The value can be up to 20 times bigger than the vario needle filter. Default value is same as vario needle filter.

SC filter sets a time constant of the speed to fly (SC) filter. The value can be up to 20 times bigger than vario needle filter. Default value is same as vario needle filter.

Relative filter sets a time constant of relative vertical speed filter (also known as super netto vertical speed). The value can be up to 20 times bigger than vario needle filter. Default value is same as vario needle filter.

Netto time defines the integration period for the average netto vertical speed in seconds. The default is 20 seconds.

5.1.5 Display

The display menu controls screen brightness. The main display unit has an ambient light sensor which detects ambient light and automatically increases or reduces the brightness of the screen.

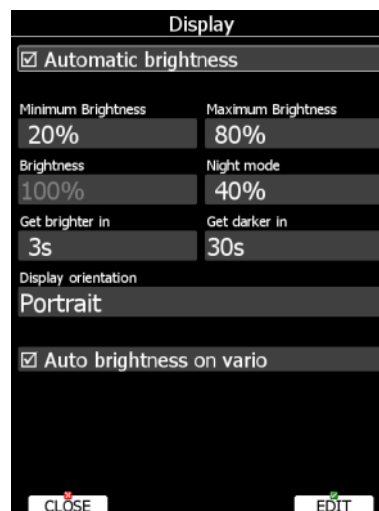

If the **Automatic brightness** checkbox is selected, the instrument will automatically adjust brightness according to current light conditions.

Minimum and **Maximum brightness** items control value limits. Use time values to setup how fast adaptation to brighter conditions or darker conditions will occur. Default values are tuned to human eyes and do not require change.

Night mode brightness defines maximum brightness when instrument is operating in night mode. In night mode brightness is reduced to very low value to reduce the difference between ambient light and device backlight.

If you want to set the brightness manually uncheck the **Automatic brightness** control and set the brightness manually.

Change **Display orientation** if you want to change the display unit screen orientation. The main display unit will restart with the new screen orientation.

Checking **Auto brightness on vario** while enable automatic regulation of brightness on vario unit, if available. If this option is unchecked the vario unit will always run at full backlight.



It is recommended that the automatic brightness control is always enabled. Reducing brightness will also reduce power consumption. See technical data for more details (Chapter 2.1.10).

5.1.6 Files and Transfers

The Files and Transfer menu is used to manage the waypoint, airspace and airport databases, recorded flights, flight declaration, PDF documents and Checklists.

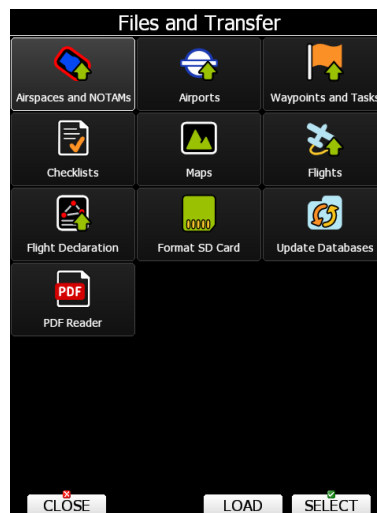

Within a profile the user can selected different airport databases, airspace and waypoint files. Selected files can be stored inside the main display unit or on an inserted SD card or USB stick.

It is also possible to upload files from SD card or USB stick to main display unit. Waypoints, Tasks and Flights can also be uploaded to LXNAV Connect.



LX8030 and LX8040 devices require add-on SD card reader to transfer files via your SD card. You can still use USB stick or transfer files via integrated Wi-Fi module.

TO LC function:

After pressing **TO LC** a window with registered storage services will pop up. The user has to select a service or email and press **SEND**.

5.1.6.1 Uploading User Airspace and Waypoints by using LOAD button

Airspace and Waypoints can be loaded from a SD card or USB stick or LXNAV Connect storage services. Select the type of database you wish to load and press the LOAD button.

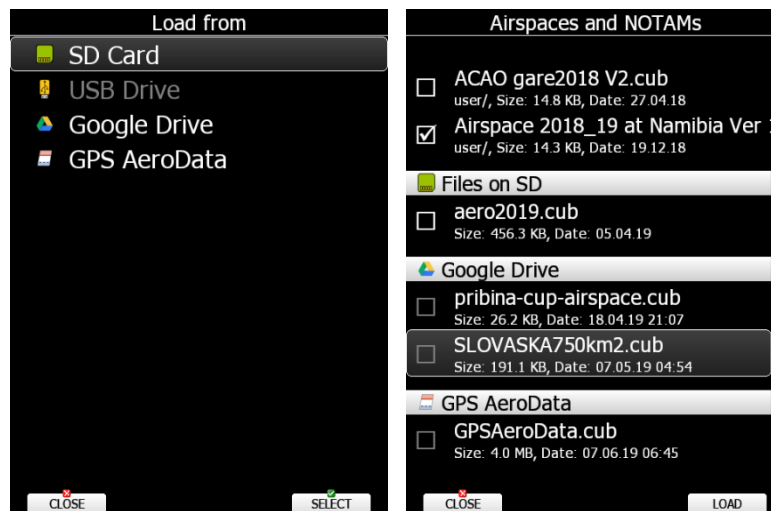

A dialogue with a list of all available files will be opened. Press the **COPY** button to copy the selected file to the main display unit. The main display unit will accept the following file formats:

- **Waypoints file:** SeeYou CUP files, CUPX files (which may include also images) and Cambridge/Win5.1.14 DAT files. When selecting DAT files waypoints will be converted to CUP format which is the format used for internal storage of points. There is no limitation for the number of waypoints in a file and/or name length.
- **Airspace file:** All types of CUB files are accepted.

5.1.6.2 Uploading Airspace and Airports Database (ASAPT)

LXNAV distributes free of charge airport and airspace database for the whole world. The airport and airspace database are regularly maintained by LXNAV. The latest version of the database can be found on our webpage www.lxnav.com.

The database is distributed as single file with **.asapt** extension. Copy this file to a SD Card or USB stick. Plug the SD card or USB stick into the main display unit and select the **Update database** menu item. If multiple ASAPT files are found on a SD card a dialogue to select the appropriate one will be shown.

Databases are updated automatically, and progress of the update will be shown on the screen.

5.1.6.3 Downloading and uploading via storage service

Since Software version 7.0 all files can be downloaded also from storage services (Dropbox/Google Drive). To set up storage service please see chapter 5.1.14.2. Any file that is compatible (for example .cup airspace file) will automatically appear in the destination (for example Files and transfer -> Airspaces and NOTAMS) once it is uploaded to one of the storage services. To download it to the instrument simply press **LOAD**. Pop up question will appear asking you if you wish to enable automatic sync for this file. This enables automatic synchronization of set file (if you modify/update it in the storage service it will automatically update on your instrument). Icon will appear next to the file if synchronization is enabled. You can also save/upload files to the storage service by selecting file(s) on you instrument, clicking **SAVE** -> LXNAV Connect -> Google Drive/Dropbox -> Send. In the same path you can also manually choose **SYNC**. Synced files will display an icon of storage service they are linked with next to them (Google Drive or SeeYou Cloud). In case of unsuccessful syncing the icon will have a red circle around it as shown below.



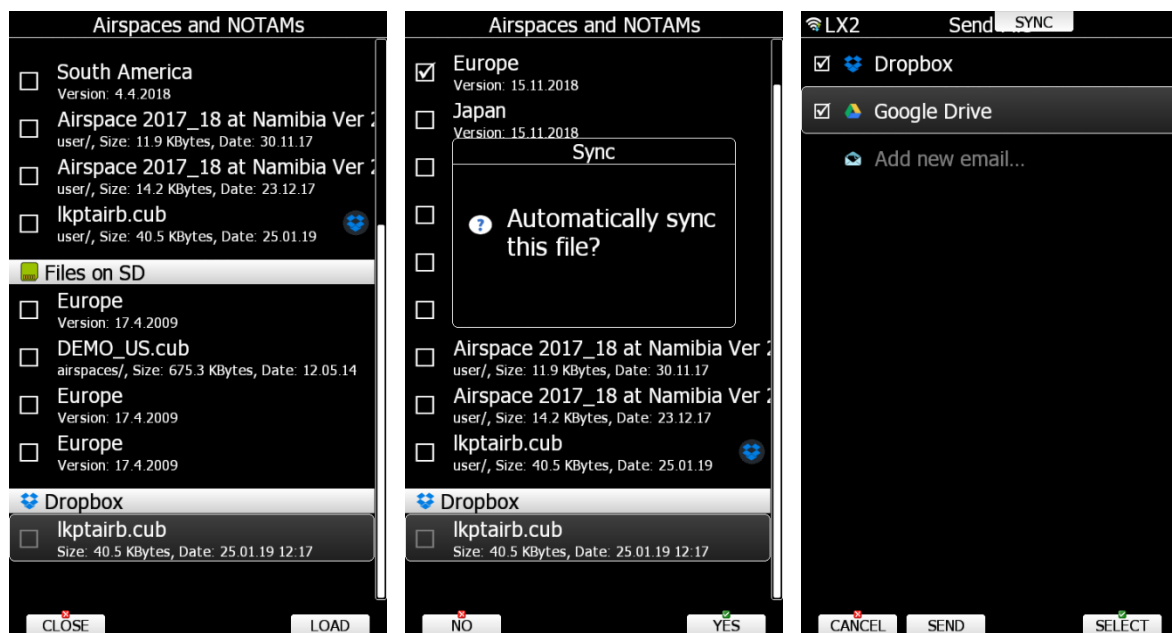

5.1.6.4 Airspace and NOTAMs

Select the **Airspace** menu item and press the **SELECT** button. A list of all available airspace databases/files will be shown on screen. The distributed airspace databases are shown first followed by user airspace files, followed by airspace files on the SD card and finally airspace files on the USB stick.

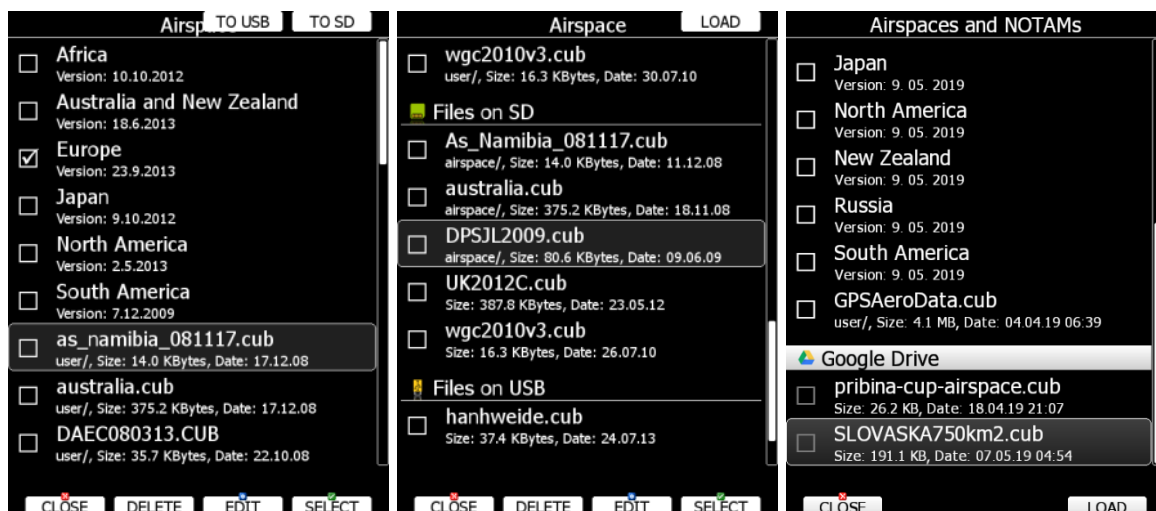

Select the required airspace and press **SELECT**. If a check mark is shown in front of an airspace item this airspace file will be shown in the graphics and used for proximity calculation when enabled.

Button labels vary depend on airspace location. For distributed airspace only, buttons **SELECT**, and **EDIT** are available. For user airspace files stored on main display unit button **DELETE**, **TO USB** and **TO SD** are added.

To delete an airspace file, select the airspace item and press the **DELETE** button. The delete action must be confirmed. Only user airspace files can be removed.

Press the **TO USB** button to copy selected airspace to the USB stick. Press the **TO SD** button to copy selected airspace to the SD card.

When an airspace file from SD or USB is highlighted the **LOAD** button is displayed. Press the **LOAD** button to upload selected airspace to the main display unit. Loading the airspace

doesn't mean it is enabled. If you wish to enable repeat the SELECT procedure as written above.



When an airspace file from USB or SD card is selected, it will be available only if a SD card or USB stick is inserted in main display unit.



Selecting airspaces on SD card or USB allows you to create portable profiles which can be transferred from one device to another.

Edit Airspace

Airspace file can be edited. Select an airspace item and press the **EDIT** button. A list of all airspace zones in this database/file will be shown. Use the page selector to scroll through the items one by one or the zoom selector to move up or down for a whole page. At the bottom of the page a map with the selected airspace zone is drawn.

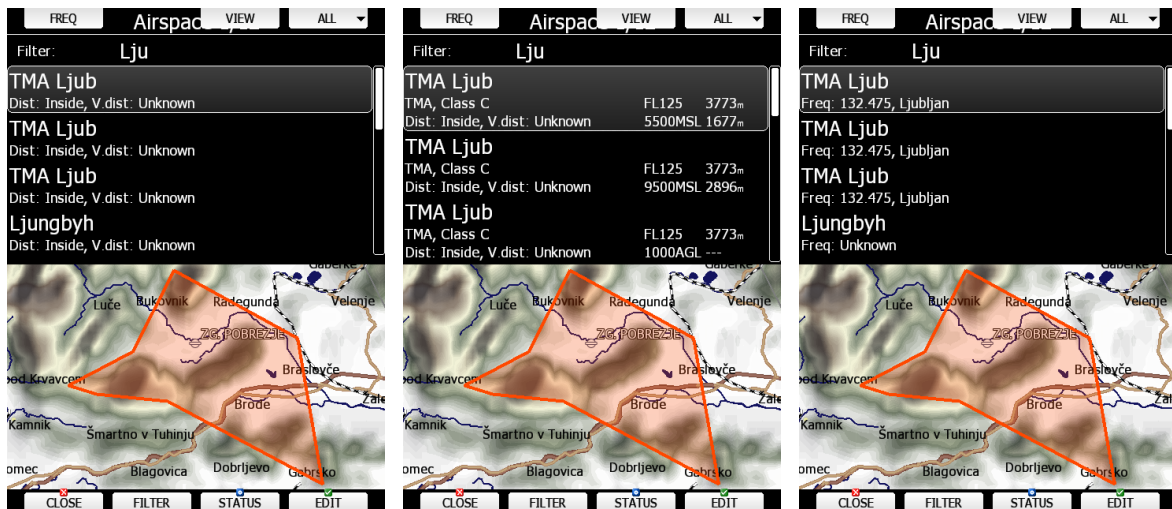

Pressing the **VIEW** button will toggle different views of the zone list.

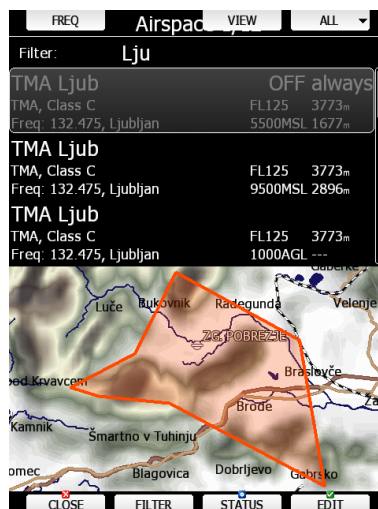

In the second column, the values are always expressed in ft.

Using the **STATUS** button, the selected zone can be disabled for proximity warnings. Repeated presses will toggle the following options:

- **OFF always:** proximity warning is switched off all the time.
- **OFF today:** proximity warning is switched off for today only.
- **OFF hh:mm:** proximity warning is switched off for 10 minutes.
- If **no label** is shown airspace is enabled for proximity warnings.

FREQ button will automatically set the frequency on the radio (if radio bridge is connected).

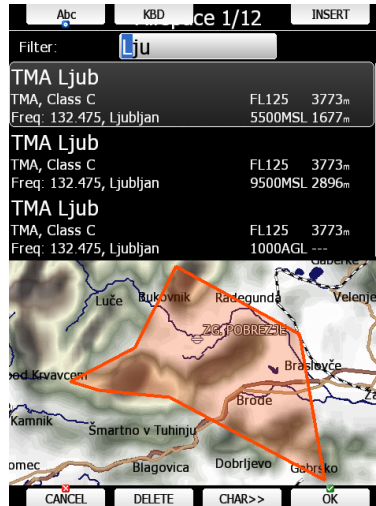

For easier sorting use **FILTER** button.

Pressing the **ALL** option will disable all airspaces for **TODAY** or **ALWAYS**. To enable them again press **ALL** and choose **ENABLE**.



Press **EDIT** to edit data for the selected zone. Airspace type, class and altitude borders can be modified in this dialog.

5.1.6.5 Airports

Select the **Airports** menu item and press the **SELECT** button. A list of all available airport databases will be shown. Only distributed airport databases are shown in this menu; the user cannot modify contents of a database within the main display unit. If an error is suspected in our database, please notify us via email info@lxnav.com.

If you wish to add additional airports to the system an ordinary waypoint file should be created and uploaded as a waypoint file or use the LXAsapt editor program to modify the airport database.

Managing Airports Using the LX Asapt Editor

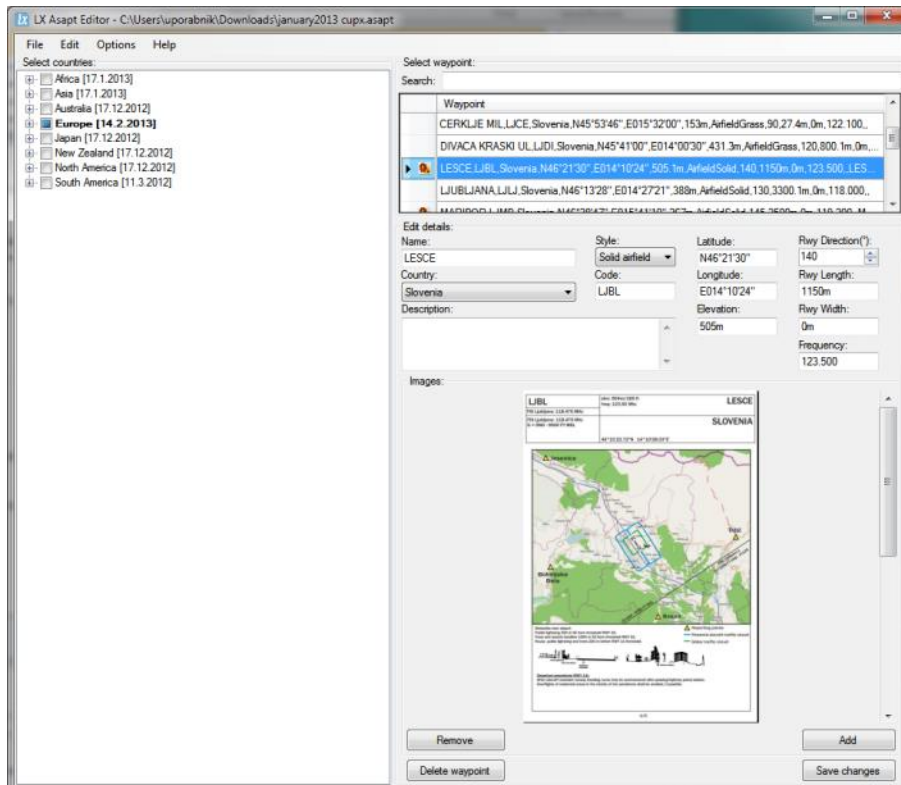

The LX Asapt Editor allows you to edit any LXNAV airport database distributed as asapt files. You can quickly filter the regions and find the airports you are interested in. View and edit all details of the airports, add charts, photos (from files or clipboard) and any other information you would like to have associated with them. You can also delete the regions you are not interested in and add new or missing airports anywhere in the world (for supported regions). The application also monitors every change you make to the database, so you can simply apply changes to a new database when it is released by LXNAV.

Modified airport data can be readily exported to the system as a (asapt) file and imported to the main display unit using the standard procedure for database updates (see Chapter 5.1.6.2).

The original database can be restored only via the update database procedure using the original database file. All databases are published on www.lxnav.com.

5.1.6.6 Waypoints and Tasks

Select the **Waypoints and Tasks** menu item and press the **SELECT** button. A list of all available waypoint files will be shown on the screen.

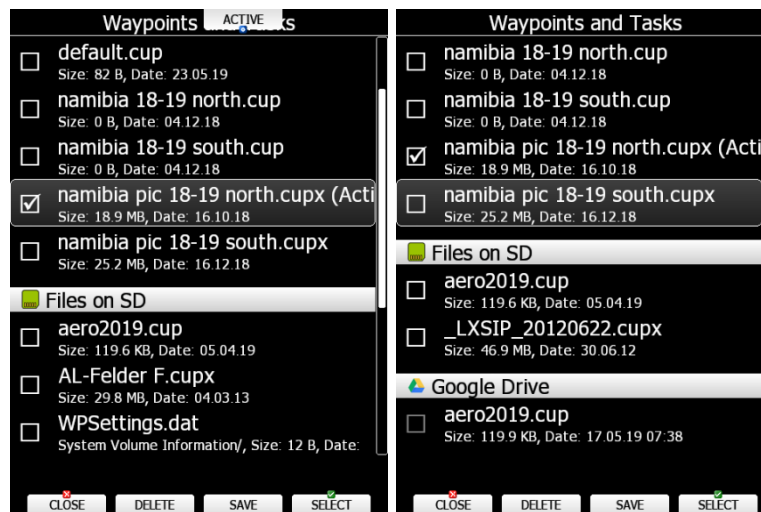

Multiple files can be selected. All checked files will be shown on the graphics page and used in the near mode calculation if the waypoint is of the proper type (airport or out landing place). However, only one file can be the active file. The active file is used for task creation. Task can be loaded only from the active file.



When a waypoint file from a USB or SD card is selected, it will be available only if a SD card or USB stick is inserted in main display unit.



Selecting waypoint files on a SD card or USB allows you to create portable profiles which can be transferred from one device to another.

Press the **ACTIVE** button to mark the selected file as active.

Press the **DELETE** button to remove the selected file from the internal storage of the main display unit.

If waypoints file from the SD or USB are selectable, the **LOAD** button is visible. Press the **LOAD** button to upload the selected waypoint file to internal storage.

If a waypoints file from internal storage is selected the **SAVE** button is visible.

The **SAVE** button allows you to save waypoints to the SD Card or USB stick or to LXNAV Connect. When you press the **SAVE** button another **dialogue box** will appear to offer you the available options, such as the SD Card or the USB Memory Stick, just Click on the option you want.

If there is no SD Card or USB installed, a button **TO LC** will be visible. Use this button to save your files to LXNAV Connect.



CUP and CUPX files also store tasks. Tasks will also be uploaded to the main display unit. This feature is very useful if you wish to prepare tasks on a computer using SeeYou or a similar program. You can subsequently easily select a task via the Task->Edit->Load option. See Chapter 5.7.5 for more details.



Some CUPX waypoint files with images are password protected and a valid password must be obtained before using such a file. Please contact the vendor to obtain a password for your display unit.

5.1.6.7 Maps

The main display unit is preloaded with terrain and vector map data for the entire planet Earth. However, it is also possible to use scanned (rasterized) maps as background for the navigational screen. The next two images show examples of scanned ICAO map and satellite imagery.

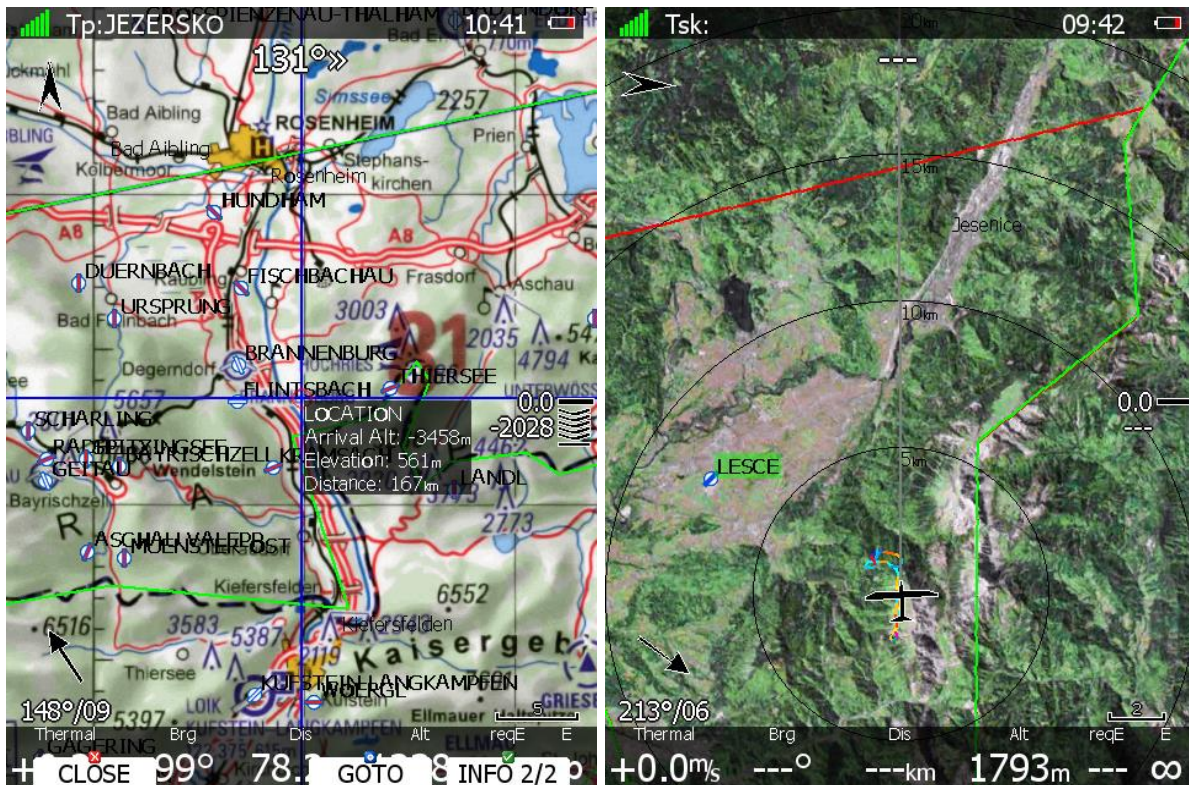

The system is supporting two file formats: CMR file format provided by SeeYou software from Naviter. There are available free of charge sectional maps of USA (www.soaringdata.info) and QMP file format provided by Ifos. Please contact Ifos (www.ifos.de) or (www.strepla.de) to purchase scanned maps.



Select the **Maps** menu item and press the **SELECT** button. A list of all available map files will be shown on the screen.

Multiple files can be selected. All checked files will be shown on the navigational page depending on the raster map setting.

Press the **DELETE** button to remove a selected map. Press the **LOAD** button to upload a selected map to internal memory.

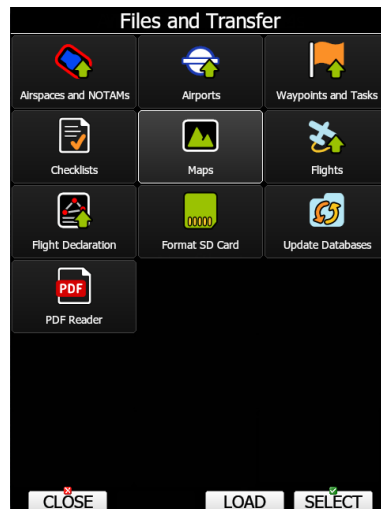

Maps can also be loaded directly from Files and Transfer menu. Scroll to the Maps icon as seen above and press **LOAD**. Select the where you want to load the map file from (SD card, USB drive, Google Drive...) and then select desired map file to load it.



When a map file from USB or SD card is selected, it will be available only if a SD card or USB stick is inserted in main display unit.



QMP maps are generated by IFOS and will work only on a system where the serial number is the same as the registered serial number on the QMP map. If serial number does not match, the map cannot be displayed.



Map files can be very large and thus occupy a lot of internal storage space within the main display unit. Selecting maps directly from a SD card or USB allows you to save space at no performance cost and create portable profiles which can be transferred from one device to another.

HGL – High Resolution Elevation Data

HGL – high resolution elevation data is an add-on package which does not come preinstalled on the device. It provides high resolution elevation data for better view of terrain as shown on the images below. HGL packages require a lot of space so we limit them to only selected regions.

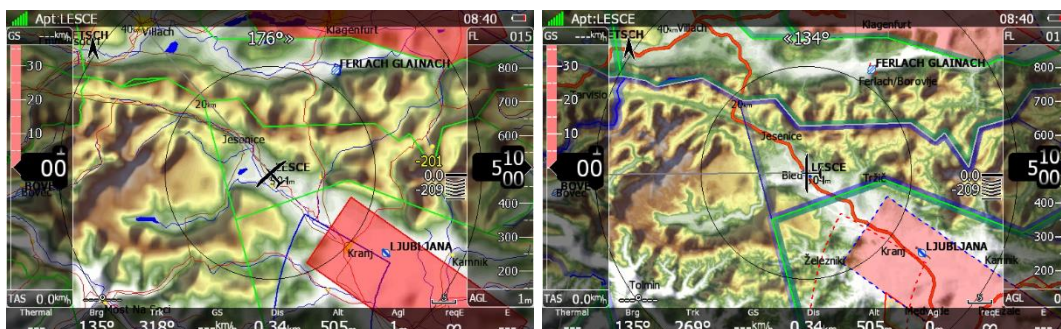

Left: terrain rendered using normal maps; right: terrain rendered using HGL.

5.1.6.7.1.1 HGL-Install Procedure

HGL terrain can be downloaded from www.lxnav.com. After downloading a selected HGL package you can install it via Setup->Password->insert 89891. The package will be unpacked into internal memory and available for selection in the Maps dialogue.



Alternatively, if you are low on internal space, you can rename the “.hglzip” extension of the package to “.zip” and extract it into a folder on a SD/USB. After inserting such SD/USB into the device your package will be immediately available for selection in Maps dialogue and will not require loading the data onto internal memory. **WARNING:** When using this option, you **MUST NEVER** remove the SD/USB before turning the device OFF.

Install via LXNAV Connect

High resolution terrain maps can be installed directly via Wi-Fi module. You need to register your device on the LXNAV Connect and add High resolution terrain packages service. A menu with available maps will appear under: Setup->Files and transfer->Maps

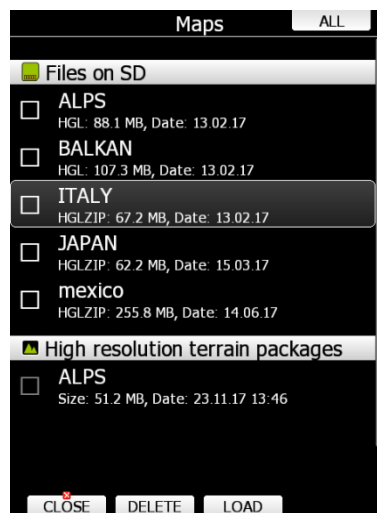

Maps CITv1/CITv2

CITv1: Regular maps containing vector and elevation data. Preinstalled on all devices.

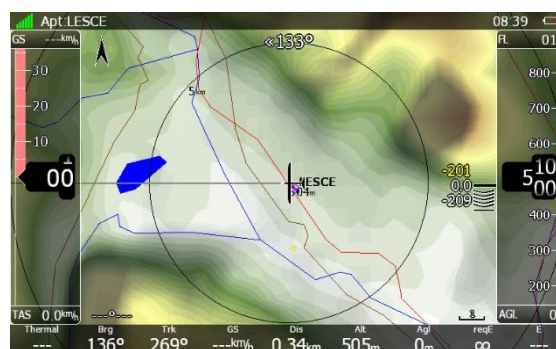

CITv2: New maps containing vector and elevation data. Supported by firmware version >5.06 and preinstalled on devices produced from 2014 onwards.

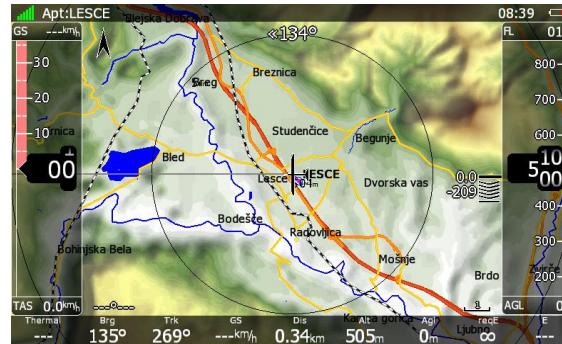

Depending on when your device was manufactured it may already contain the new maps (CITv2). Installed maps can be seen in "SETUP-ABOUT" dialogue (after installing version 6.0+).

You will see "Installed maps: CITv1, CITv2 (used)" if you have newer maps installed. If not then it will state "CITv1 (used)".

5.1.6.7.1.2 CITv2-install Procedure

If CITv2 is not preinstalled then you will need to verify that enough free space is available on your device before installing CITv2 maps.

Installation on your device is as follows:

1. Verify that you have enough available free space on internal memory by going to Setup->Password and enter 00111. Verify that "FreeMem CF" value displayed is at least 3.8 GBytes.

2. Download CIT files from:

<https://gliding.lxnav.com/lxdownloads/maps/>

These files will also be automatically verified while being copied to your device. To prevent discovering a faulty download "on site" you can (optionally) verify downloaded files on your

PC using a tool like HashCheck <http://code.kliu.org/hashcheck/>

After installing HashCheck you can double click on the checksums.md5 file to automatically trigger verification of downloaded CIT files.

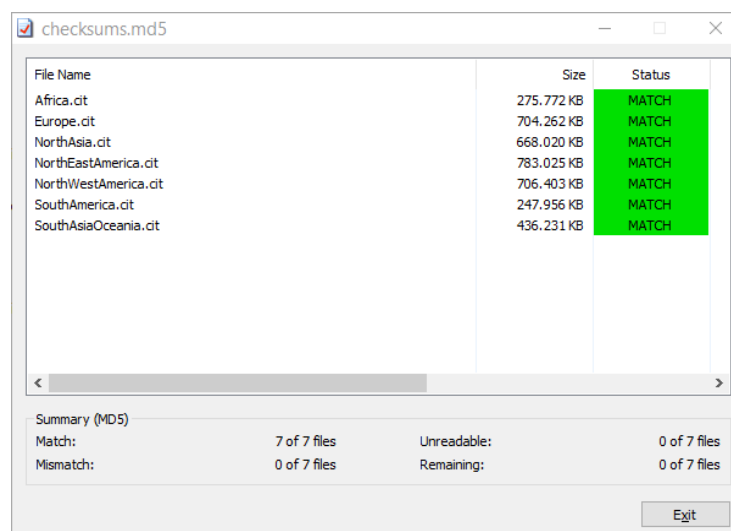

Verification of Downloaded Files with the HashCheck Tool

3. Copy the downloaded CIT files to USB or SD and use "Safely remove hardware or eject media" (**very important!**) before removing the SD or USB from the PC. This step prevents accidental removal of the media before files are fully written to it. Removal while files are being written would result in corrupted files on the media.

4. Install the latest version of the firmware on your device.
5. With the SD/USB containing CIT files inserted into your device go to Setup->Password and enter 00112. You will now be asked "Map (CIT) file(s) have been detected on external media. Would you like to copy them to internal memory?" Press "Yes".

The copy procedure will begin and the maps will be copied to internal memory. You will see an estimation of time to finish (ETA) on your device. It may take up to an hour, so prepare accordingly (sufficient battery, time).

After copying it should state 'OK' for all copied files. If it does not then it's likely that you have a faulty CIT file on the external SD/USB media (return to step 3 or 2, if you suspect a faulty download).

After exiting this dialogue, the device will automatically restart and when it starts again you can verify installed and used maps in the "About" dialogue.



If you do not have enough space available and you wish to have the CITv2 maps, you should contact LXNAV about the HW/memory upgrade.

5.1.6.8 Flights

Select the **Flights** menu item and press the **SELECT** button. A list of all stored flights will be shown. The main display unit is capable of storing more than 1000 hours of flight logs.

Flights 1/17						
#	Date	Takeoff	Landing	Duration	Engine	
1	27.08.19	18:10	19:00	00:50	05'45"	
Task dist.: ---km, Speed ---kmh, OLC dist.: 25.7km						
2	27.08.19	16:12	16:43	00:31	00'00"	
3	06.04.19	14:09	15:52	01:43	00'00"	
4	09.12.18	13:52	17:53	04:01	00'00"	
5	14.11.18	11:00	18:31	07:31	06'13"	
6	10.08.18	13:21	16:54	03:33	00'00"	
7	11.06.18	12:38	16:38	04:00	00'00"	
8	19.04.18	12:57	16:57	04:00	05'39"	
9	23.06.17	15:08	17:29	02:21	00'00"	
10	23.06.17	13:08	16:28	03:20	00'00"	
11	24.06.16	14:38	14:38	00:00	02'00"	
12	21.06.15	10:31	14:06	03:35	100'00"	
13	13.05.15	09:49	10:39	00:50	99'59"	
14	11.01.11	11:41	18:17	06:36	00'00"	

Flights 1/17						
#	Date	Takeoff	Landing	Duration	Engine	
1	27.08.19	18:10	19:00	00:50	05'45"	
Task dist.: ---km, Speed ---kmh, OLC dist.: 25.7km						
2	27.08.19	16:12	16:43	00:31	00'00"	
3	06.04.19	14:09	15:52	01:43	00'00"	
4	09.12.18	13:52	17:53	04:01	00'00"	
5	14.11.18	11:00	18:31	07:31	06'13"	
6	10.08.18	13:21	16:54	03:33	00'00"	
7	11.06.18	12:38	16:38	04:00	00'00"	
8	19.04.18	12:57	16:57	04:00	05'39"	
9	23.06.17	15:08	17:29	02:21	00'00"	
10	23.06.17	13:08	16:28	03:20	00'00"	

Flights 1/17						
#	Date	Takeoff	Landing	Duration	Engine	
1	27.08.19	18:10	19:00	00:50	05'45"	
Task dist.: ---km, Speed ---kmh, OLC dist.: 25.7km						
2	27.08.19	16:12	16:43	00:31	00'00"	
3	06.04.19	14:09	15:52	01:43	00'00"	
4	09.12.18	13:52	17:53	04:01	00'00"	
5	14.11.18	11:00	18:31	07:31	06'13"	
6	10.08.18	13:21	16:54	03:33	00'00"	
7	11.06.18	12:38	16:38	04:00	00'00"	
8	19.04.18	12:57	16:57	04:00	05'39"	
9	23.06.17	15:08	17:29	02:21	00'00"	
10	23.06.17	13:08	16:28	03:20	00'00"	

Press SAVE button to see options for saving flights. A selection dialog will open. If a SD card or USB stick is inserted into the main display unit, flights can be copied to it when the corresponded button is pressed. If your profile is linked to LXNAV Connect account, you will be able to copy flight to all LXNAV Connect services available. If you do not have LXNAV Connect account, Email option is available to send file via email. See chapter 5.1.15 for more details about LXNAV Connect.

Here you can also delete a single flight by pressing "DELETE" in the bottom left. To delete all flights at once use code 99999 in the password menu (see chapter 5.1.17).

5.1.6.9 Flights Declaration

In this menu point the pilot can check the current declaration settings (Pilot, Glider and Task declared). The flight declaration can be SAVED and also LOADED (.hdr file). If Nano flight recorder is connected to the device, declaration can be uploaded to it.

5.1.6.10 Formatting a SD Card

Use this option if the main display unit cannot read a SD card. The system uses the same card format as used by the MS-Windows operating system (FAT). However sometimes Windows does not format the SD card properly or a new card may not be formatted properly. It is recommended to format new SD cards before using them.

Formatting a SD Card will erase the entire contents of the SD card.



The maximum SD card size for old device (built before 2015) is 4gb.

5.1.6.11 Update Databases

Under this section you can upload databases such as:

- asapt extension (airspace and airport database file provided by LXNAV)
- fln (FlarmNet file)
- obs (FLARM obstacle file)

LXNAV distributes free of charge airport and airspace database throughout the whole world. The airport and airspace database are regularly maintained by LXNAV. The latest version of the database can be found on our webpage www.lxnav.com.

The database is distributed as single file with **asapt** extension. Copy this file to an SD Card or USB stick. Plug the SD card or USB stick into the main display unit and select the **Update database** menu point. If multiple ASAPT files are found on a SD card a dialogue window to select the appropriate one will pop up.

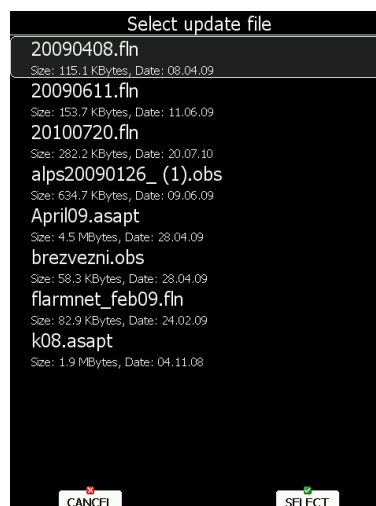

Databases are updated automatically, and the progress of the update will be shown on the screen.

5.1.6.12 PDF Documents

The main display unit can store an almost unlimited number of PDF documents. Here the user can store here flight manuals, maintenance manuals, scans of all gliding documents and checklists.

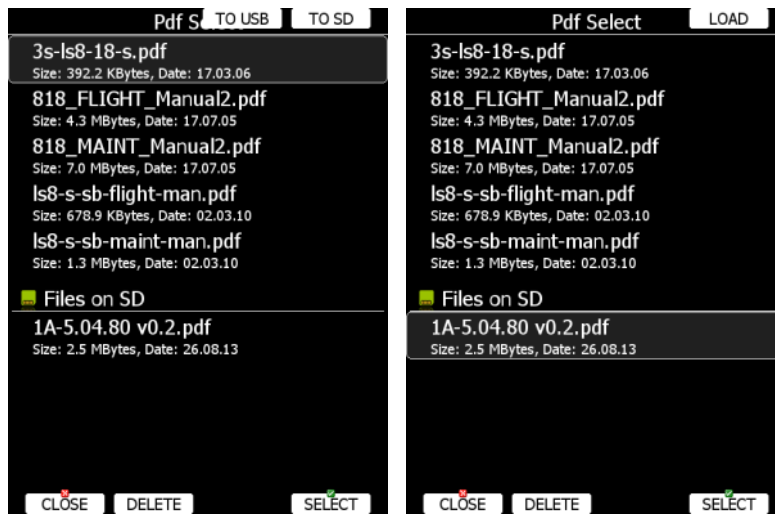

Select the **PDF READER** menu item and press the **SELECT** button. A list of all available PDF documents will be shown on the screen. Select the desired document using the PAGE selector. Press the **DELETE** button to delete the selected document. Press the **LOAD** button to upload a selected document into internal memory.



Documents can be very large and thus occupy a lot of internal storage space within the main display unit. It is not necessary to copy documents to internal memory. Documents can be selected directly from a SD card or USB at no performance cost.

Press **SELECT** button again to open selected document.

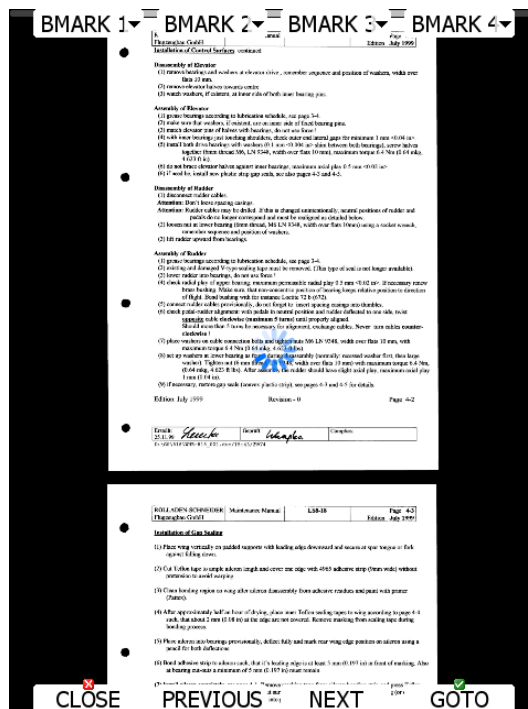

A document will load within few seconds. Use the **PAGE** selector or the **NEXT** and **PREVIOUS** button to move up/down through document. the **ZOOM** selector to zoom

within the current page. Use the MODE selector to move left/right within the selected page. Press the **GOTO** button to navigate to specific page. A goto dialogue will open. Use the PAGE or ZOOM selector to select the desired page

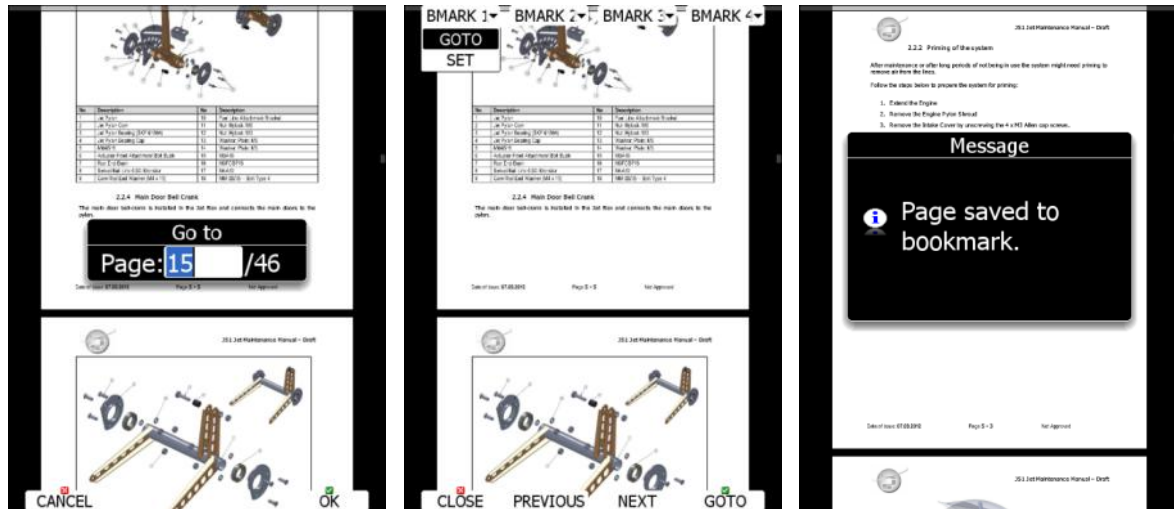

It is also possible to set four independent bookmarks. Press **BMARK1** to open the bookmark drop down menu. Press the **BMARK1** button once more to set a bookmark. A message will confirm that bookmark has been saved.

5.1.6.13 Checklists

Use this dialogue to load a checklist, delete checklists, save checklists or edit an existing checklist file. The active checklist file is the profile which is currently being used. Select a checklist file using the PAGE selector knob. Press **SAVE**, where you will have an option **TO USB** or **TO SD** for the checklists file to be stored on a USB stick or SD card. A file is stored in a file with the **.checklists** extension. Press the **LOAD** button to load a file from an SD card or USB stick. A profile will be copied to the main display internal storage. Press the **EDIT** button to edit the checklist's file name.



Checklists can be found on the last page of APT/WPT and TSK page. Once the action of the checklist is performed press the **CHECK** button. To move through the actions on the checklist use the **NEXT** or **PREVIOUS** buttons.



A checklist file can be created / opened and manipulated with the LXStyler program. LXStyler is a special program designed for customising layout of navigational pages. It can be downloaded free of charge from our web page www.lxnav.com. For more information about LXStyler please refer to the LXStyler manual.

Creating a checklist file

- Open the latest version of LX Styler.
- Click on FILE->NEW CHECKLISTS.
- Select your instrument size and orientation.
- Double click on the blank black page which will open the customization menu.

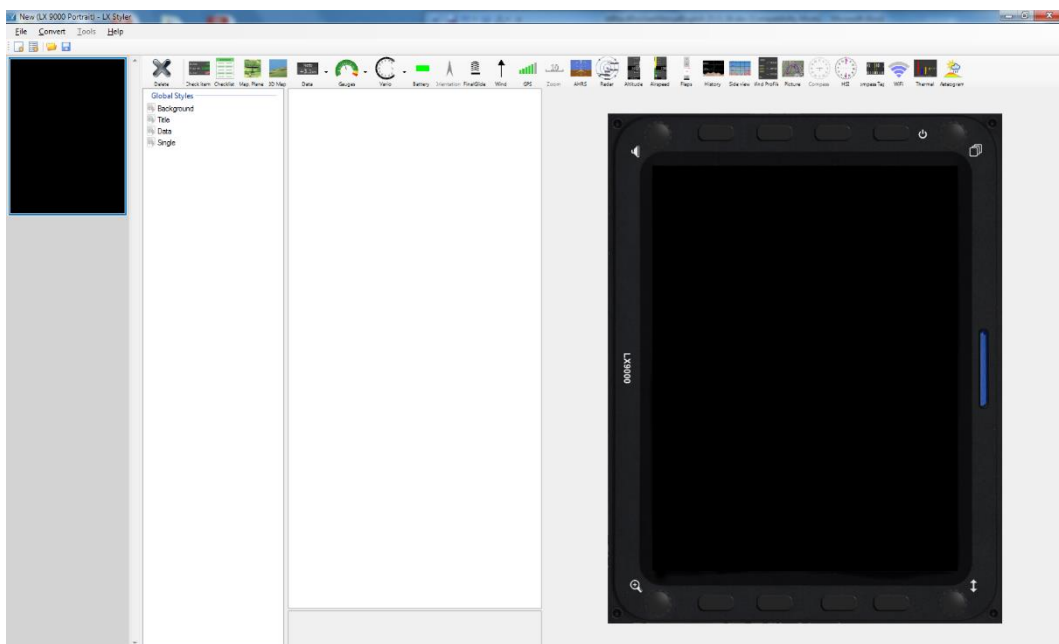

- Click on the Checklist icon.
- A new window **create multiple labels** will open.
- Now you can set gaps, vertical and horizontal space and text aligns.
- Put the text into the table left and right.

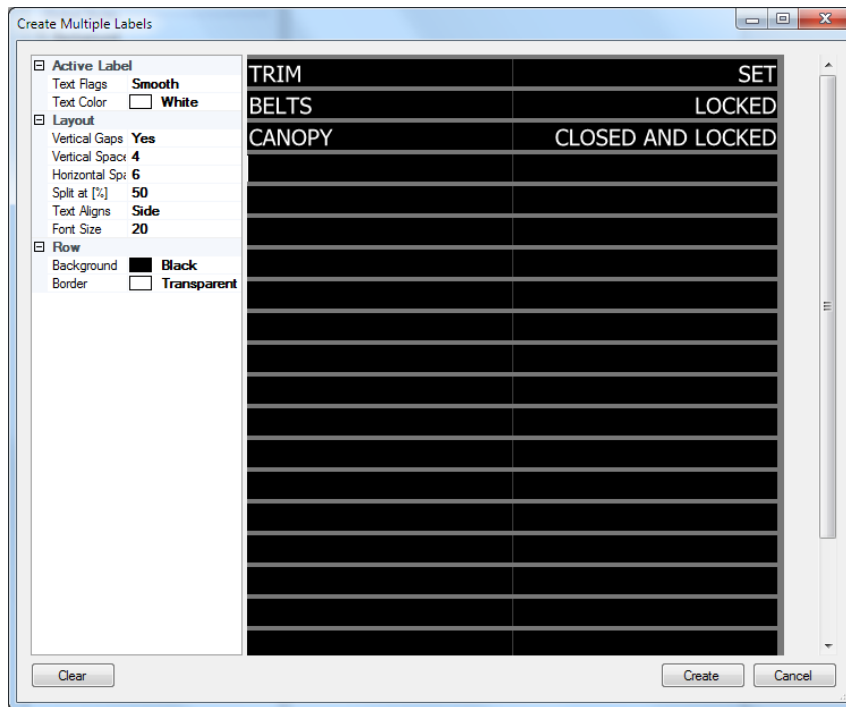

- Once finished, press the **create** button.

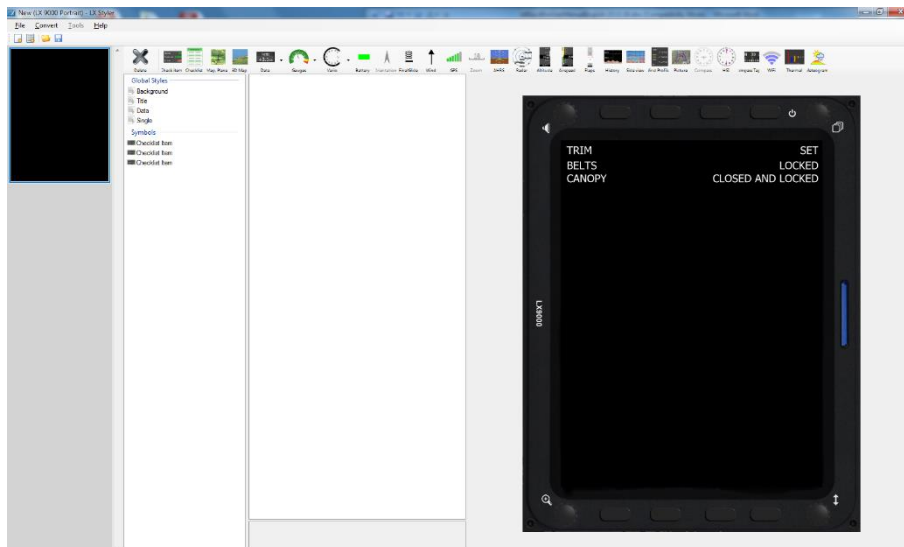

- Press **save** to save the checklist file on the PC/SD card or USB. The file has the extension **.checklists**

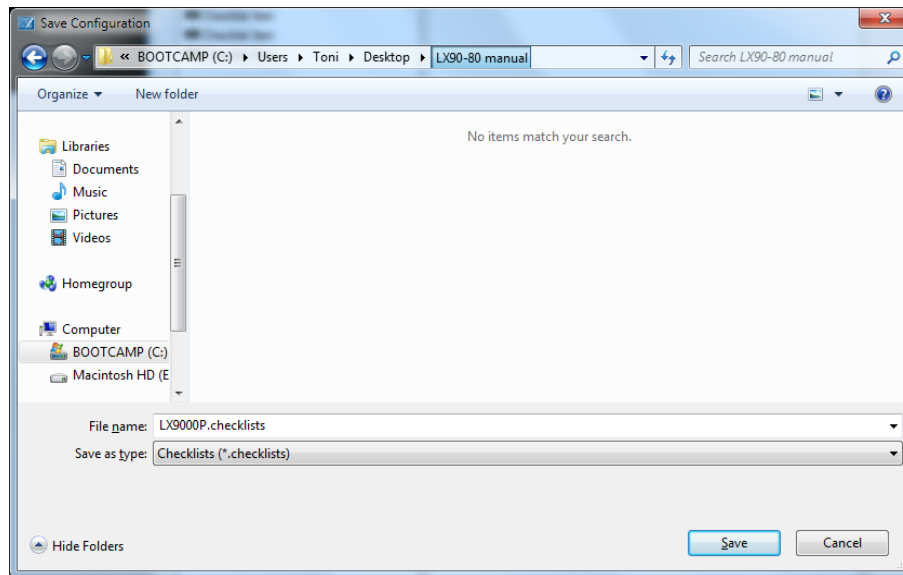

- Go to LXxxxx instrument Files and Transfer ->Checklists and load the file from the SD card/USB stick.

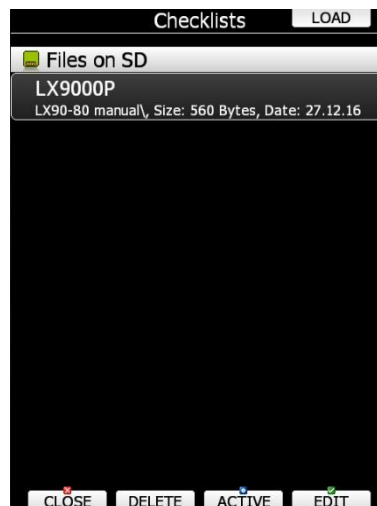

- The checklist is automatically added to the last page of the ATP/WPT and TSK screen.

5.1.7 Graphics

This dialogue allows the user to define the appearance of the map in navigational mode. Select the **Graphics** menu item and press the **SELECT** button. A submenu will open.

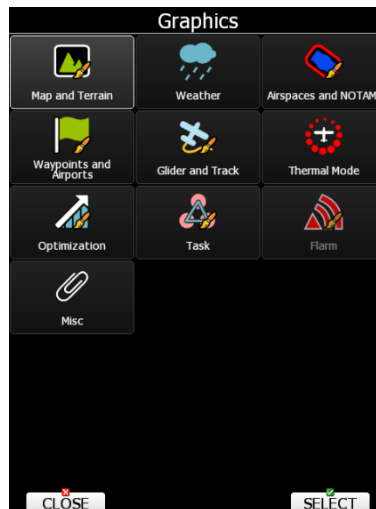

5.1.7.1 Map and Terrain

The main display unit is pre-loaded with terrain and vector maps for the entire planet Earth. The database includes: elevation contour lines, water bodies, roads, highways, railways, big cities and a digital elevation model. The database is derived from the OSM free database. The database cannot be modified by the user.

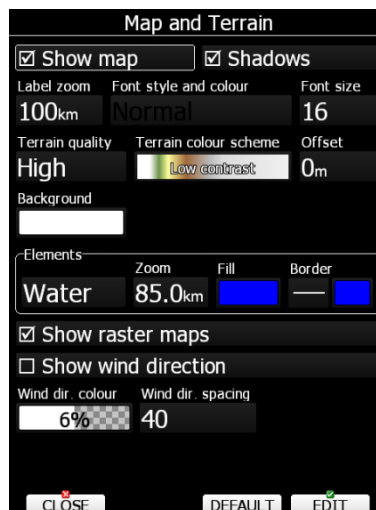

Check the **Show map** item to enable map displays in the navigational pages. If this item is unchecked no map will be displayed. Check **Shadows** if your terrain is to be shaded. The **Label zoom** value defines up to which scale of zoom city names are visible. 100km means the whole width of the screen represents 100 km. The user can also modify size, font style and colour via the **Font style and colour** item. Use the ZOOM selector knob to modify the colour and the PAGE selector knob to modify the style. Press the **PICK** button to define colours more precisely.

Terrain can be rendered in three different levels. A higher level means more detail. The main display unit is optimised to work with high terrain quality. If the value **off** is selected no terrain will be shown; only water bodies, roads, railways and cities.

The background colour is defined by the **Background** item. The default background is black. **Offset** allows you to move the ground level for the selected scheme.

Colours of terrain can be changed using different terrain colour schemes. The following colour schemes are available:

- **Mountain** is the default setting with colours from green to white at 2000 m.
- **Flatland** is a setting where colours are changing up to 1000 m.
- **Flatland2** is a setting where in low terrain is white, otherwise normal colours are used.
- **Low contrast:** same as Mountain but colours are not so intensive.
- **High contrast:** same as Mountain but colours are more intensive and from 0-100 m white colour is used.
- **Zebra** alternating colours are used.
- **Zebra 2,** less intensive alternating colours are used.
- **ICAO** colouring is similar to ICAO maps.
- **Cliffs** colours emphasis slopes and is similar to Google maps display
- **Atlas** colour scheme is approximation of Imhof colouring widely used in map books.
- **Grayscale**
- **OSM**
- **Himalaya**
- **Relative** is a colour scheme related to the current altitude (unreachable areas are coloured from orange to red, reachable areas are white).

In the **Elements** group land features are setup separately. **Zoom** defines up to which zoom level a selected land feature is visible. Also, the line width and colour can be setup.

Press the **DEFAULT** button to reset this back to default.

Following elements are available Water, Road, Highway, Railroad, Town, Track, Airport, Minor Water, Forest, Street and Minor roads



If you have checked shadows and you are flying over flat areas with elevation close to MSL or below, black spots will be displayed on the terrain. These black spots will disappear if you uncheck shadows.

Check **Show raster maps**, if you would like to see also scanned maps (see also Chapter 5.1.6.7).

Check **Show wind direction** if you would like to see lines indicating the direction of the wind.



5.1.7.2 Weather

If the Wi-Fi module is installed the **Weather** menu is also available. During flight there is a possibility to obtain real time weather data if the Wi-fi module is connected to the 3g hotspot and if the hotspot has mobile signal reception. There are three layers: Satellite, Forecast and Rain radar. You can enable/disable each layer and then customize it by selecting service you wish to use and the parameter (layer) you wish to display. You can also define the level of each layer's transparency by adjusting the **opacity**. At the bottom of the page there are four additional settings. **History span** controls data retention and

"playback" time for data from live services. It defines a time span for how many (past) time slices are animated on the map. If set to 0, there is no data animation. **Freeze present time** relates to history span. If history span is not 0 then "freeze present frame" defines for how long the newest data slice is shown during an animation. This helps to distinguish old data from present data. **Forecast time** is the time offset for the prediction data. The displayed data is prediction data at current time + forecast offset. Forecast has no animation like real time data. You will only see overlay for set forecast delay. **Minimum zoom distance** is the amount of zoom above which weather layers become visible (if this is set to 0km weather layers will always be visible). If more than one layer is enabled, they all will be seen.



It is highly recommended to change your layout to accommodate weather layers. Information about layers can be displayed on screen with a **Weather info** navbox and item legend can also be added. The easiest way to do this is by using LX Styler or fist testing it out with LX Sim weather demo profile.

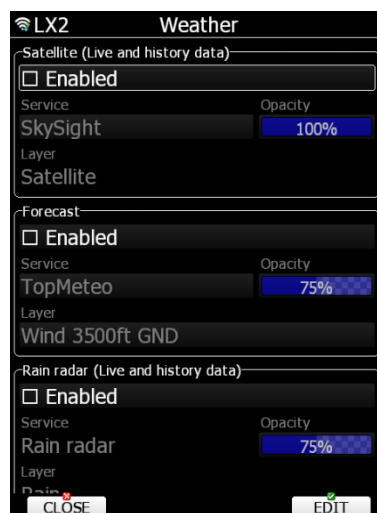

Although internet access is required to download and view the weather layers, they will still be visible after you lose the connection (e.g. while flying). Instrument will save the last information until the end of the day. Radius of 500km of live weather data is preloaded before flight and the forecast map of the currently needed sectors (for example whole Europe sector).

Satellite layer (live and history data)

This layer shows current (live) data and history data from satellite. TopMeteo and SkySight services are supported and only one layer ("Satellite"). To use this layer, you need a TopMeteo or SkySight account (see below).

Forecast

Second layer supports two services, TopMeteo and SkySight. It is used for forecasting weather data. You can choose between multiple layer options. To use this layer, you need TopMeteo or SkySight account (see below).

Rain radar

Enabling rain radar will show the radar picture layer over the map. Animation is showing how the rain is moving over the map and its intensity. To freeze the last picture, adjust the

Freeze present time as described above. This service does not require any 3rd party login or registration.

SkySight

SkySight is soaring weather forecast for Australia & New Zealand, South Africa, Europe, America and Japan. For purchasing or starting a free trial please visit <https://skysight.io/>. Weather can be loaded during flight or even preloaded in the morning and then seen during the whole flight for the actual time available. SkySight account is required. Also see Chapter 5.1.14 on how to add SkySight on your list of services.

Available SkySight layers are: Thermal Strength & B/S Ratio, Height of Thermals, Depth of Thermals (AGL), Cu Depth, Cu Cloud base, Overdevelopment, CAPE/Storms, Rain, Mid level cloud cover, High level cloud cover, Forecast Satellite View, Ridge Lift, Surface Wind (2m), Boundary Layer Wind (Avg), Convergence, Vertical Velocity 600m/1.5km/3km/4km/5km, XC Speed, Freezing Level and Turbulence

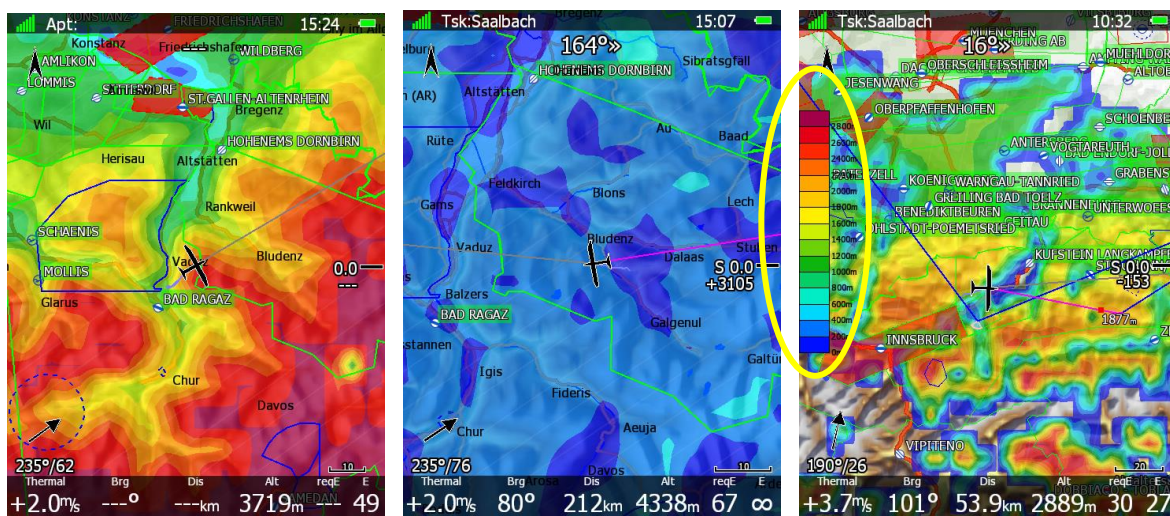

To enable **legend**, go to layout editor for selected page and add item legend. You can then adjust its size and position as described in Ch. 6. Legend will change depending on what weather data is selected.

TopMeteo

TopMeteo is a gliding forecast that allows pilots to have daily overview for cross country optimization and with the help of LX Connect also in-flight weather right on your LX80xx&LX90xx instrument. You can find more information and purchase TopMeteo on <https://topmeteo.com>.

Available TopMeteo layers are:

- Satellite (Satellite layer)
- Potential flight distance (18m) (Forecast layer)
- Cloud distribution (Forecast layer)
- Wind 3500ft (GND)

More layers will be added with future updates.

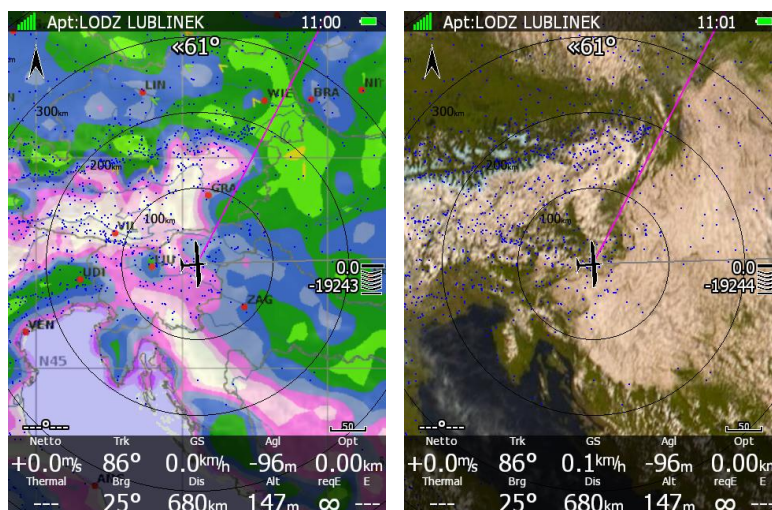

5.1.7.3 Airspace and NOTAMs

In this dialogue you can define the airspace map presentation. Check the **Show airspace** item to enable airspace displays within navigational pages. If this item is unchecked no airspace will be displayed.

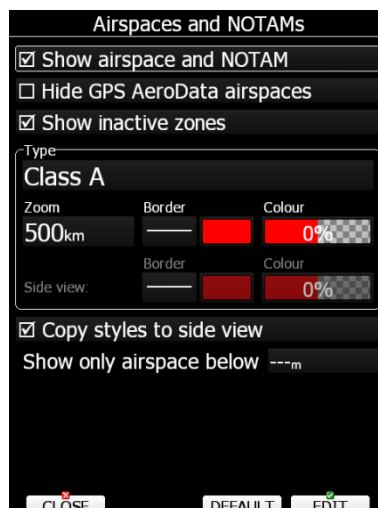

If you don't want to see GPS AeroData airspaces select **Hide GPS AeroData airspaces**. If the **Show inactive zones** option is checked, then airspace zones with proximity warning switched off will be shown. Use **Show only airspace below** to eliminate airspace which is going to be too high for the day. For example, if the forecasted cloud base is to be 1500 m, set this value to 1600 m and your screen will be much more readable. In the **Type** panel you can specify how each airspace type is displayed. You should define each type of airspace zone separately. First choose an airspace type from the list. The **Zoom** value defines to which zoom level this type will be visible. The **Colour** and **Width** items specify how selected airspace zone will be drawn. You can also modify the transparency of the selected type. Turn the ZOOM selector knob to change the transparency value. 0% means completely transparent and only the airspace zone outline will be shown. 100% means completely solid (not recommended). The image below shows examples of combinations of Width and Colour property and rendering of the airspace zone.

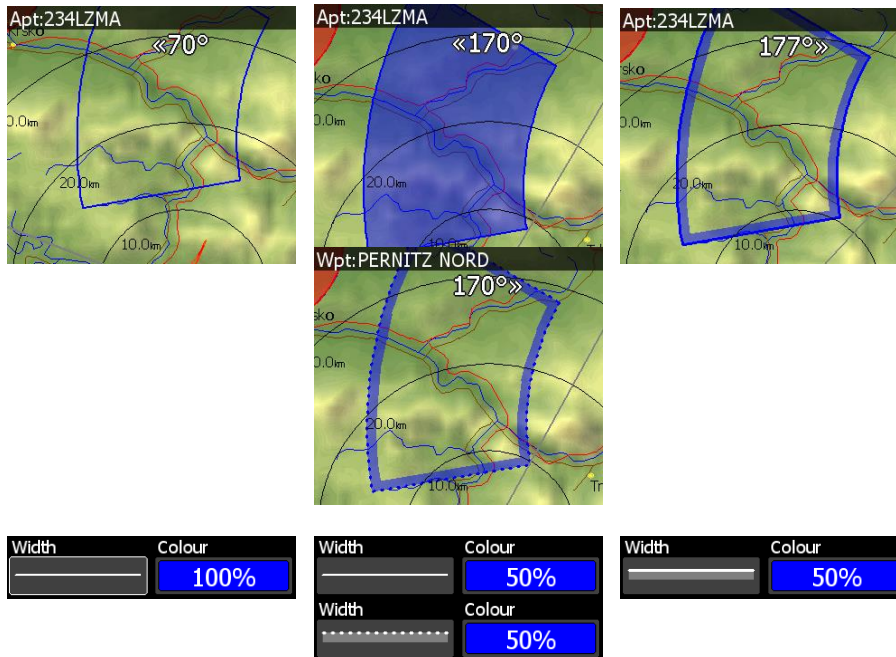

You can set separately airspace colour and border for side view and map view if the option **Copy styles to side view** is not checked. Press the **DEFAULT** button to reset these settings back to default.



As seen in an example above airspace will NOT be coloured in if the Width type is set as line and a secondary transparent line (examples 3 and 4).

5.1.7.4 Waypoints and Airports

The waypoint and airport look, and feel is defined in this dialogue. Check the **show waypoints** item to enable waypoints and airports display in navigational pages. If this item is unchecked no waypoints will be displayed. If **duplicates** are checked duplicated points might be shown on map when same waypoint (airfield) is defined in a user file as in the airport database. Use **show only airports from database** to display only airports from the database within airport mode.



The **Max.visible** item defines how long waypoint labels and detailed symbols are shown. If the maximum number of waypoints on the current screen is more than the defined value

only small blue dots will be shown for waypoints and no labels will be drawn. **Symbol size** can be adjusted as well.

Font style, colour and size can be defined using the **Font style and colour** item and the **Font size** item. When editing style, turning the ZOOM selector knob will change the font colour.

Waypoint labels can be setup to give even more detail. Label details can be defined for each individual waypoint type (all types, all landable, unknown, waypoint, mountain top, grass airfield, out landing, glider site, solid airfield, mountain pass, sender, VOR, NDB, Cooling tower, Dam, Tunnel, Bridge, Power plant, Castle, Intersection, Marker).

A label consists of two selectable values: upper label and lower label. If you prefer labels in single line, the **single label** checkbox should be checked. A label can also be coloured. Check the **Colorize label** item. Coloured labels are drawn with a green background when the waypoint is within range with the current MacCready setting and with a yellow background when the waypoint is within reach with MacCready setting zero. No background is shown if the waypoint is not reachable.

The label is selected from following options:

- **Name:** the waypoint name is shown. The name length item controls how the name is displayed.
- **Code:** will display the ICAO code or short name.
- **Elevation:** shows waypoint elevation.
- **Arrival altitude:** shows arrival altitude taking into account current MacCready setting, safety altitude and current wind. Due to complexity of the calculation it will not take the wind profile into account.
- **Required altitude:** shows how much height is needed to reach the point. Required altitude takes into account current MacCready setting, safety altitude and current wind. Due to complexity of the calculation it will not take the wind profile into account. More can be found on the graphical explanation below.

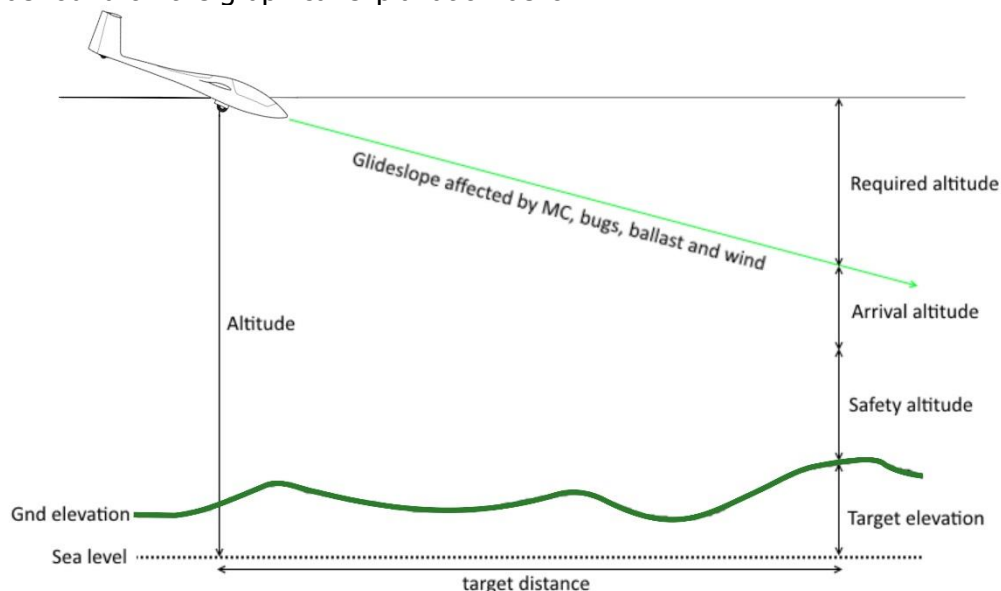

- **Required Mc:** gives an estimate of the maximum MacCready value which we can use to reach the point. In this calculation is taken in account also wind.
- **Required L/D:** shows the required glide ratio to the point taking into account the safety altitude.
- **Team code:** shows the team code for that waypoint.
- **Frequency:** will display the point frequency if available.

Define **minimum runway length** and **minimum runway width** to filter out too short and too narrow runways. Such landing places will be shown in nearest list anyway, but they will be marked with red cross to indicate that they are not usable.

Near			
Name	Dis	Brg	Arr
✘ BELLUNO	52.3km	165°	1214m
Rwy: 05/23-G-812m/0m Freq: 119.650 Elev: 378m Description:			
♦ BOLZANO	59.6km	252°	1164m
✘ LIENZ NIKOLSDO	65.0km	72°	731m
✘ Lienz	65.5km	72°	716m
✘ Enemonzo	67.0km	110°	878m
♦ AVIANO AVIANO	177.1km	147°	797m
♦ PORDENONE COM	83.1km	146°	695m
✘ Rivoli	88.3km	118°	500m
♦ INNSBRUCK	89.9km	322°	129m
✘ ZELL AM SEE	92.6km	36°	-60m
♦ ASIAGO	92.2km	207°	-585m
♦ TRENTO MATTARI	98.5km	227°	104m
✘ ST JOHANN/TIROI	104km	16°	-267m
♦ RIVOLTO RIVOLT	104km	132°	155m

Press the **DEFAULT** button to reset these settings back to default.



When runway direction is not available a circle with dot inside will be drawn rather than symbol with approximate runway direction.

5.1.7.5 Glider and Track

The navigational screen can show the coloured path flown, current track vector and target vector with terrain collision warning.

Glider and Track

Show path

Path colour Path width Path length Path style

829min vario

Show current track

Track colour Track width Target colour Target width

Show target Show collision

Font style and colour Font size

Normal

Show range circles

Range colour Range width

0%

Engine colour Engine width

Show glider range area

CLOSE DEFAULT EDIT

Glider and Track

Show current track

Track colour Track width Target colour Target width

Show target Show collision

Font style and colour Font size

Normal

Show range circles

Range colour Range width

0%

Engine colour Engine width

Show glider range area

Area colour Area border Fill area

36% outside

Glide ratio

CLOSE DEFAULT EDIT

Check the **Show path** item if you want to see the flown path. **Path length** defines how much of the flown path will be shown. The path can be coloured using:

- **Fixed** path style. The path colour is fixed and defined by the path colour item.
- **Mc** path style, which is based on current MacCready settings. Red colour indicates segments of the flight where we have vertical speed higher than the current MacCready setting. Orange colour shows vertical movements similar to the current MacCready setting and blue for vario values below the MacCready setting. Grey depicts sink areas. When HAWK is enabled, HAWK data is used for this colouring.
- **Vario** path style, where red colour indicates positive vertical speed and blue colour negative vario values.

- **Altitude** path style, where red colour means low altitude and blue means high altitude.
- **Ground speed** path style, where red colour means slow speed and blue colour means fast speed.
- **Hawk Netto** path style, where red colour indicates positive netto vertical speed and blue colour negative netto values.

Check the **Show current track** item if you would like to see your current ground track vector. **Track colour** and **width** defines the colour and width of the current track vector. Selected target and current position are connected with a magenta line.

Check **Show target** if you would like to see this line. In the target colour and target width you can select the **Colour** and **Width** of this line. You can also choose to show or hide the terrain collision point and the target line itself. The terrain collision marker is a red square which is only displayed when there is terrain between the navigational point and the current position and therefore not enough altitude to reach the target with the current glider settings. **Font Style**, **Colour** and **Size** define which font for terrain collision altitude and range circles.

Enable **Show range circles** to plot range circles around the aircraft symbol. Having range circles on navigational screen makes it much easier to guess the distance to the nearest point of interest. **Range colour** and **range width** define the way circles are rendered. A built-in engine noise level sensor detects if engine is running or not. Use **Engine colour** and **width** properties to visualize part of path where engine was running.



Use **Show glider range area** to display the reachable area from the current altitude with current wind and MacCready settings. Use **area colour** and **area border** to define its properties.

The area can be filled outside or inside. **Fill area** can be outside or inside the range area



Glider range area calculation is based on safety MacCready and calculated wind.

Glide ratio defines averaging time for the current efficiency calculation which is used for current glide ratio.

Press the **DEFAULT** button to reset these settings back to default.

5.1.7.6 Thermal Mode setup

When entering a thermal the display unit can enter a special page, which is called the thermal page. See Chapter 6 or the LX Styler manual for how to define the thermal page.

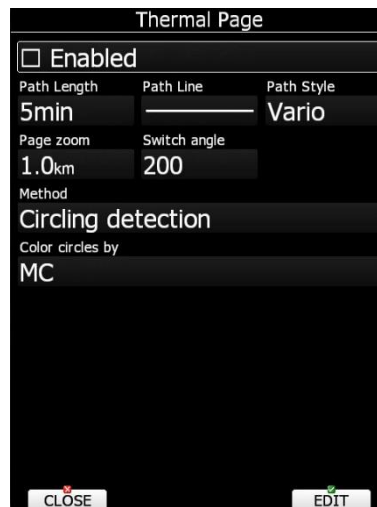

Check **Enabled** to enable the thermal page option. The displayed path on the thermal page can be different from the one defined in Glider and track dialogue. Use the **length, line** and **colouring** properties to define the path display. Also, page zoom is different and set to a fixed value defined with the **Page zoom** property. Switching to thermal mode can be done in 2 ways: Circling detection or Switching SC/Vario. If you start circling the thermal mode will become active at the angle of turn (set switch angle), or if you switch from SC to Vario mode. Circles can be coloured based on the following methods: Auto span, MC Hawk Netto, when available or Average Vario.

5.1.7.7 Optimization

The main display unit calculates the optimised flown distance according to OLC or FAI rules in real-time during the flight (see Chapter 5.1.9). It calculates the available FAI triangle area, which is also called the FAI triangle assistant. If you enter this area and return to the start point your flight forms a triangle according to FAI rules. The Optimisation dialogue is used to define the look and feel.

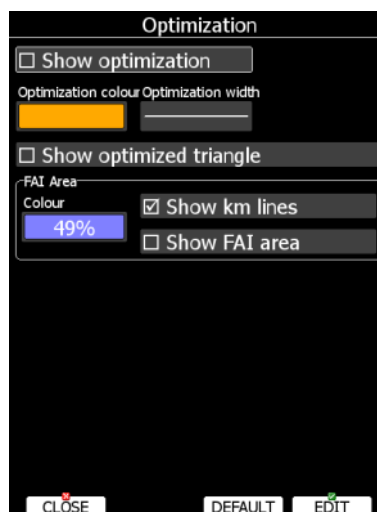

Check the **Show optimization** item to enable display of the optimised track. **Optimization colour** and **width** defines the colour and width for these lines.

If **Show optimized triangle** is checked also lines for the largest optimised triangle are shown. Please note this might not be a triangle according to FAI rules.

The FAI Area group defines how the FAI area is drawn. Select the **Colour** item to change the colour of the FAI area. Use the ZOOM selector knob to change transparency of the area. 0% means completely transparent and only the outline will be drawn. 100% means completely solid (not recommended).

Check the **Show km lines** item to see lines which indicate what will be the size of the completed triangle.



These lines will always be plotted in kilometres scale regardless of the Units value.

5.1.7.8 Task

Use this dialogue to define how a task is drawn in task mode.

Task colour defines the colour of task lines. **Obs.zone colour** defines colours for observation zones. Use the ZOOM selector knob to change transparency of area. 0% means completely transparent and only the outline will be drawn. 100% means completely solid (not recommended). When **Show flown task** is checked also the flown task will be drawn. This might be useful when flying assigned area tasks.

The **Show selected zone only** item controls whether all task observation zones are to be displayed or, if there is only one, then that alone will be shown.

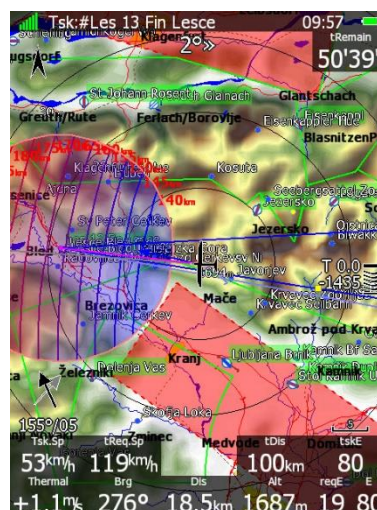

When **Show optimal track** is enabled, a small blue arrow is drawn next to the aircraft. This arrow indicates the optimal direction to fly.

AAT isolines are showing expected speed, delta time or expected distance, which means if you turn to a next point at any of the lines, you will have the results indicated next to the line based on the calculation to the next turn point zone.

AAT fill is filling the zone. The zone becomes transparent if you are "too early, too short or task delta time is not 0", if the zone is solid colour, you are already "too late, flew too long in the zone or your task delta time is not achievable".

AAT text colour is set by default to red, but it can be changed as well (colour and opacity).

5.1.7.9 FLARM

The system can be equipped with the internal or external FLARM module. If your device is equipped with FLARM this menu will allow you to modify the presentation of the FLARM radar display.



FLARM radar is not available if competition or privacy modes are active. Refer to Chapter 5.1.12.5.

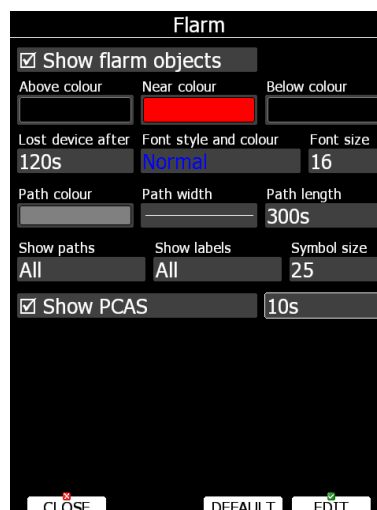

Checking **Show Flarm object** will enable display of aircraft detected by FLARM.

Colours are designed to present three values. The colour for aircraft more than 100 meters above your current altitude is defined by the **Above Colour** item. The colour for aircraft more than 100 meters below your current altitude is defined by the **Below Colour** item. The colour for aircraft that are less than 100 meters below or above your current altitude is defined by the **Near Colour** item.

When a signal from a particular aircraft is lost the aircraft remains blinking on the screen for the duration defined in the **Lost device after** item (default 120 seconds). After that time the aircraft symbol will be removed.

The **Show labels** combo box defines for which FLARM objects altitude and vertical speed are displayed next to the aircraft symbol. The user can modify size, font style and colour. Select the **Font style and colour** item. Use the ZOOM selector knob to modify colour and the PAGE selector knob to modify style.

It is possible to display the flown path of tracked aircraft. **Path colour** and **Path width** define width and colour of paths. The **Show paths** combo box defines for which FLARM object paths will be visible.

Symbol size defines the size of the symbol of a FLARM object.



If **privacy is ON**, Flarm object will be seen as a dot.

Check **Show PCAS** to see non-directional traffic on the navigational screen. Non-directional traffic will be drawn with a dotted circle at the received distance from the aircraft position. PCAS timeout is setup separately in next time spin control.

5.1.7.10 Misc

Statistics thermals count, and button settings can be set here.

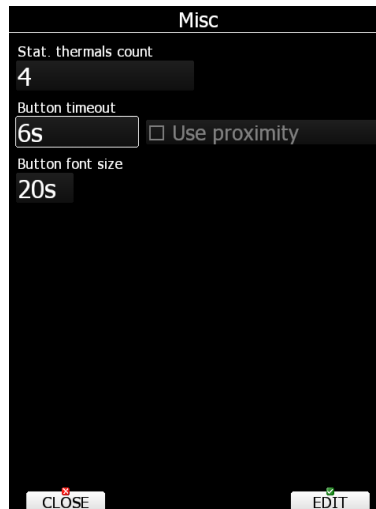

The How long the screen buttons appear for can be set by modifying the **button timeout** time (number of seconds). You can also set the button so that just touching it will give a response. This is called '**proximity**'. By ticking or unticking the box you can set this feature to be on or off. If the **proximity** feature is off, then you have to push the button in far enough so that it 'clicks' to obtain a response. Also, **button font size** can be set here.

5.1.8 Sounds*

In the Sounds setup page audio settings, voice settings and alarms settings for the vario unit can be modified.

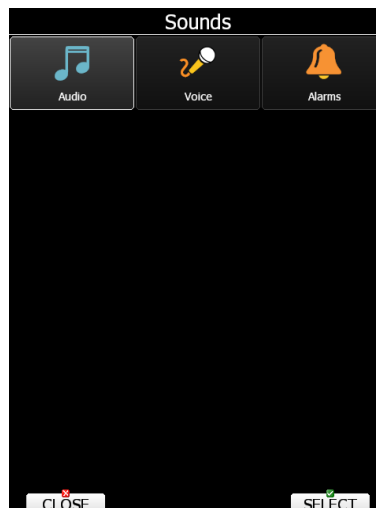

The volume can be also controlled using the upper left rotary knob. Rotating it will directly change the volume for sounds which are currently being played. For example, if a voice message is being played the voice message volume will be set. If an alarm is beeping the alarm volume will be set. In speed to fly mode the speed to fly volume is set and in climb mode the vario volume is set. Radio volume can be adjusted as well.



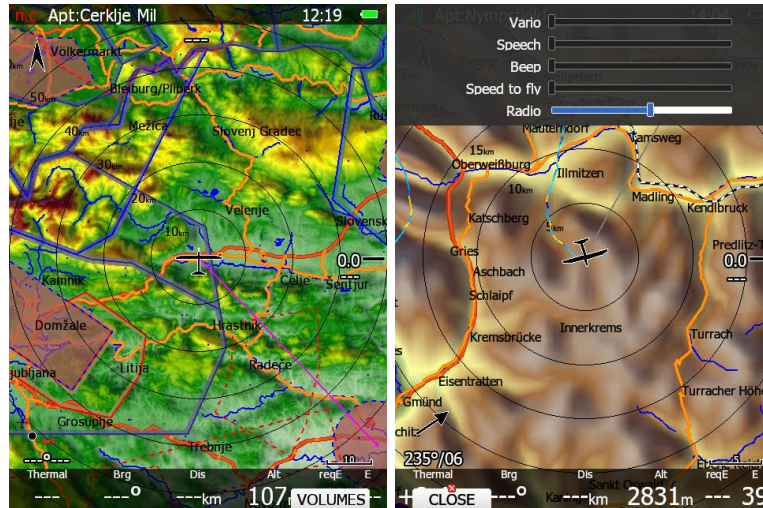

When the button **VOLUMES** is pressed a menu will appear enabling the user to set up all volumes at same time.

5.1.8.1 Audio Settings*

Basically, here we can set up two types of audio; one audio sound for climb mode and another for cruise mode (SC).



Vario audio mode has the following options:

- **Linear positive:** sound is interrupted with silence every few milliseconds when the needle is positive; on negative side sound is linear (not interrupted).
- **Linear negative:** inverse function to **Linear positive**.
- **Linear:** sound is linear and non-interrupted in full scale range.
- **Digital positive:** similar to **Linear positive**, except frequency is not changing linearly but with larger steps.
- **Digital negative:** inverse function to **Digital positive**.
- **Linear positive only:** sound is present only at positive values; for negative values there is silence.
- **Digital positive only:** similar function to **Linear positive only**, except the sound is similar to the digital tone.

Press the **DEMO** button to hear the selected option.

SC audio mode has four modes:

- **SC positive:** sound is interrupted with silence every few milliseconds when the needle is positive; on negative side sound is linear (not interrupted).

- **SC negative:** inverse function to SC positive.
- **SC:** sound is linear and non-interrupted in full scale range.
- **SC Mixed:** for positive relative values the sound represents relative; for negative relative values the sound represents SC (for that setting it is recommended to set SC needle to relative).
- **Relative:** it will beep with same tone as in vario mode for relative value.
- **Netto:** it will beep with same tone as in vario mode for netto value.
- **Vario:** it will beep with same tone as in vario mode.

Freq at 0% defines the tone frequency at 0 m/s.

Freq at +100% defines the tone frequency at full + deflection.

Freq at -100% defines the tone frequency at full – deflection.



SC volume item is visible only for Variometer preceding the V5 Variometer, where it was not possible to separately set the volume for speed to fly mode and for climb mode. It is highly recommended to upgrade such Variometer to a newer one. Please contact info@lxnav.com for more details.

Vario audio source is shown when **HAWK** option is activated. You can choose between **HAWK** or TE vario audio source for variometer sound.

SC audio source is shown when **HAWK** option is activated. You can choose between **HAWK** or TE vario SC audio source for speed to fly sound.



Here is hint for one audio setup option, if you are not using SC mode and HAWK is enabled. Set SC audio to Vario and set SC audio source to HAWK. Now you will have audio based on TE once in vario mode and audio based on HAWK once in SC mode.



In order to change the cruise volume level, one must be in cruise when adjusting the volume knob.

5.1.8.2 Voice*

The voice module is an integrated part of the V5, V9 or V80 Variometers. The voice module is 100% controlled through the main display unit via the settings described in this menu.

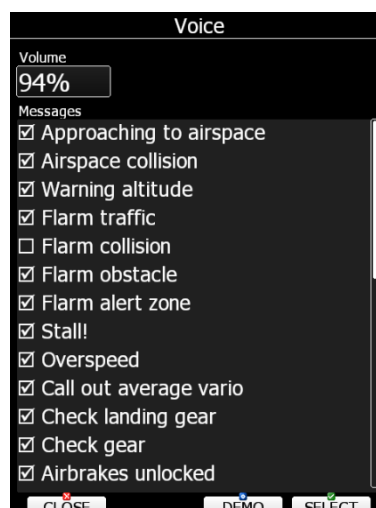

In the **Voice** menu volume level (loudness) of the voice module can be adjusted. In the Messages window each item can be set separately. Only checked items will be played by the voice module.



Mixed item is visible only for Variometer preceding the V5 Variometer where it was not possible to separately set the volume for voice messages. It is highly recommended to upgrade such variometers to a newer one. Please contact info@lxnav.com for more details.



Volume level (loudness) can be also set with volume rotary knob whilst messages are being played.

5.1.8.3 Alarms*

The vario unit produces an audio alarm on reaching certain confirmation points. This screen allows the parameters of the audio to be configured. If a particular message item is checked the main display unit will generate an alarm at the time of the event.

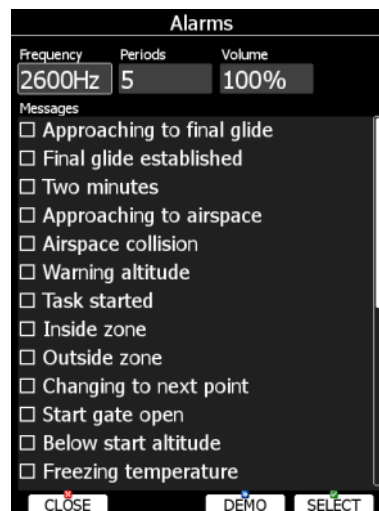

Frequency and **Periods** define the length and pitch of the alarm. Press the **DEMO** button to play the alarm sound. Change the volume to define then loudness of an alarm.



Volume level (loudness) can be also set with volume rotary knob whilst an alarm is being played.

5.1.8.4 Observation Zones

This menu defines the default observation zone geometry. The following items can be chosen: start zone, turn point zone, finish zone and templates.

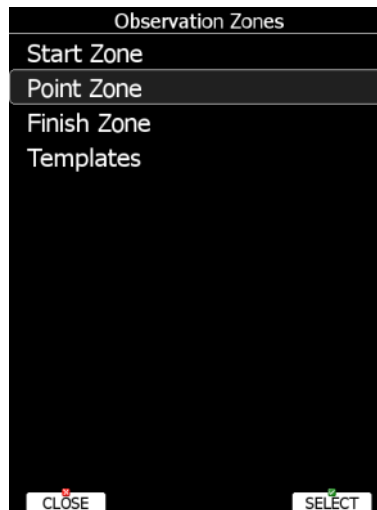

Each type of observation zone is defined with two angles, two radii and a mean bearing (**Angle12**). These parameters enable the creation of any known zone geometry separately for start, turn point and finish.

All stored tasks will match this "global" setting except those where the zone was modified in the task edit menu (see Chapter 0).

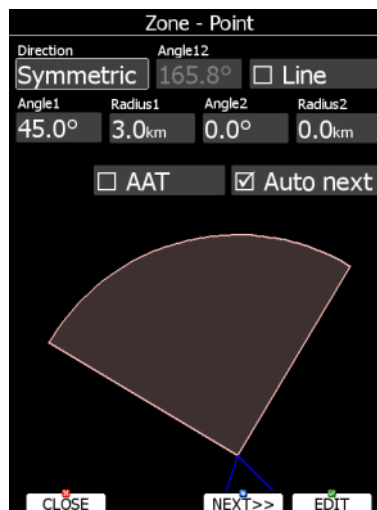

Using parameters in the zone dialogue it is possible to describe all types of observation zones. **Angle12** defines the orientation of the observation zone. Available values for **Direction** are:

- **Symmetric:** This is the most common selection for turn point.
- **Fixed:** This is mostly used for assigned areas.
- **Next:** will orient the observation zone in direction of the outgoing leg. This is usually used for the start.
- **Prev:** will orient the zone in direction of the incoming leg and is usually used for the finish.
- **Start:** orientates the sector always towards the start.

If the **Line** checkbox is checked the sector will become a line type of observation zone. The **Radius 1** parameter defines half the line length. Use the PAGE selector knob to increase the radius by 0.1 of the selected distance units and the ZOOM selector knob to increase the radius by 5.

If **Line** is not checked the **Angle1** parameter will define the basic shape of the observation zone. A value of 180° means that the zone is a cylinder whilst 45° is the classical FAI sector. Rotate the PAGE selector knob to increase the angle by 0.5° or use the ZOOM selector knob to choose values 22.5° , 45° , 90° or 180° .

Angle2 and **Radius2** are used for more complex observation zone setups.

When changing observation zone parameters, the screen is automatically updated to display the new zone.

Check the **AAT** checkbox if you want to make the selected zone an assigned area. The **AAT** checkbox will be automatically checked when **Radius1** is greater than 10 km.

By default, navigation to task points will be automatically advanced; uncheck **Auto next** if you do not want to change over to the next point when reaching the selected point. This option will be automatically unchecked when **Radius1** is greater than 10 km.

Use **Template** if you wish to modify start, point and finish zones at the same time.

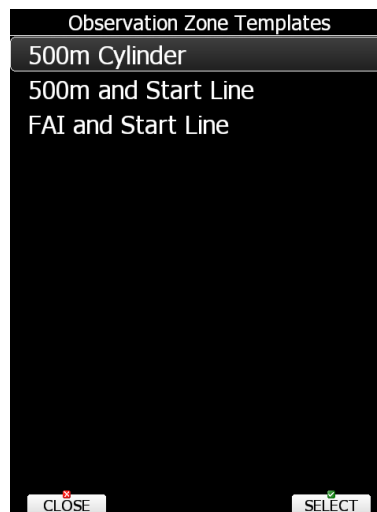

Available templates are:

- 500 m cylinders are used for start, points and finish.
- 500 m and start line. The 500 m cylinder is used for turn points. A 1 km long line is used for start and finish.
- FAI and start line. 90° and 3 km long sector is used for turn points. A 1 km long line is used for start and finish.

5.1.9 Optimization

During flight the system optimizes the flown path according to OLC or FAI rules. Use this dialogue to change the way the instrument performs this optimization.

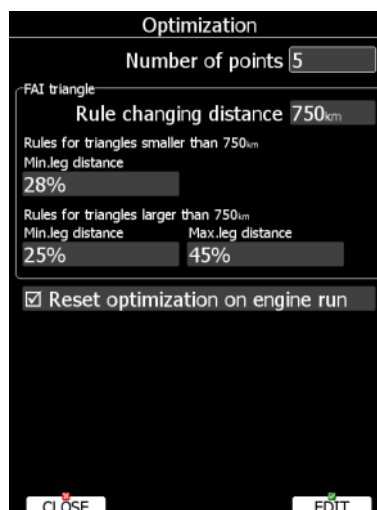

Number of points defines the type of optimization. Use five for OLC optimization. Use the value three for FAI free flight optimization.



Optimization will not take into account the 10 km distance between turn points which is required by FAI rules.

The FAI triangle group defines the rules for FAI triangles and these rules can bend a little if you do not want to fly marginal triangles.

Check **Reset optimization on engine run** to reset the optimization counter each time the engine is started.

5.1.10 Warnings

There are six types of warnings available. Airspace warnings are shown when approaching a particular airspace zone. Altitude warnings are shown when approaching a defined altitude, FLARM warnings are triggered when conflicting traffic is in the vicinity, Time Alarms are raised at defined time intervals to remind pilot to perform a specific task, the Gear warning is triggered at a pre-defined above ground level altitude setting and a Waypoint warning will be given at set distance to a Waypoint.

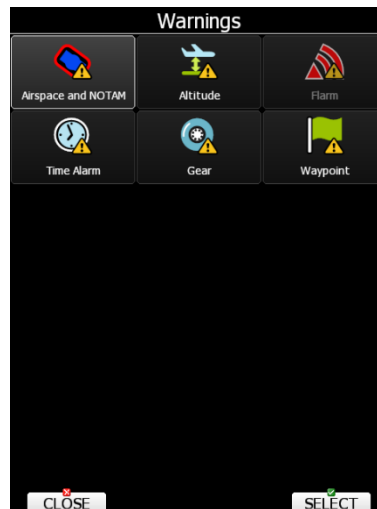

Use this dialogue to setup the behaviour of warnings.

5.1.10.1 Airspace Warnings

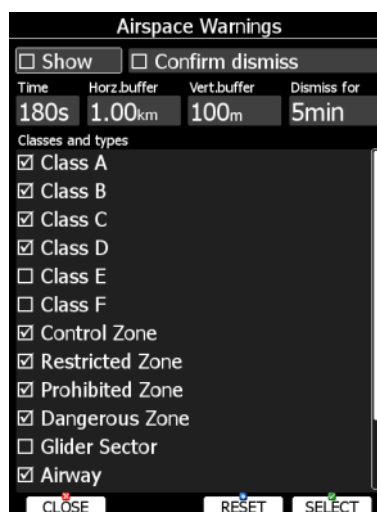

Airspace warnings are the most complex ones. An airspace warning is activated by two triggers; the first warning (orange) will be given when a projected position of flight for period, which is defined in the **Time** item, is computed to cross an airspace zone.

The second warning (red) will be raised when a projected position of flight is computed to cross an airspace zone and the glider is already in the buffer zone in the vertical or horizontal directions. Buffer zones are defined in the **Horz.buffer** and **Vert.buffer** items. Default values are 1 km for horizontal buffer and 100 m for vertical buffer.

The first warning (orange) will also be given when you enter an airspace zone buffer, but the projected flight is computed to cross it.

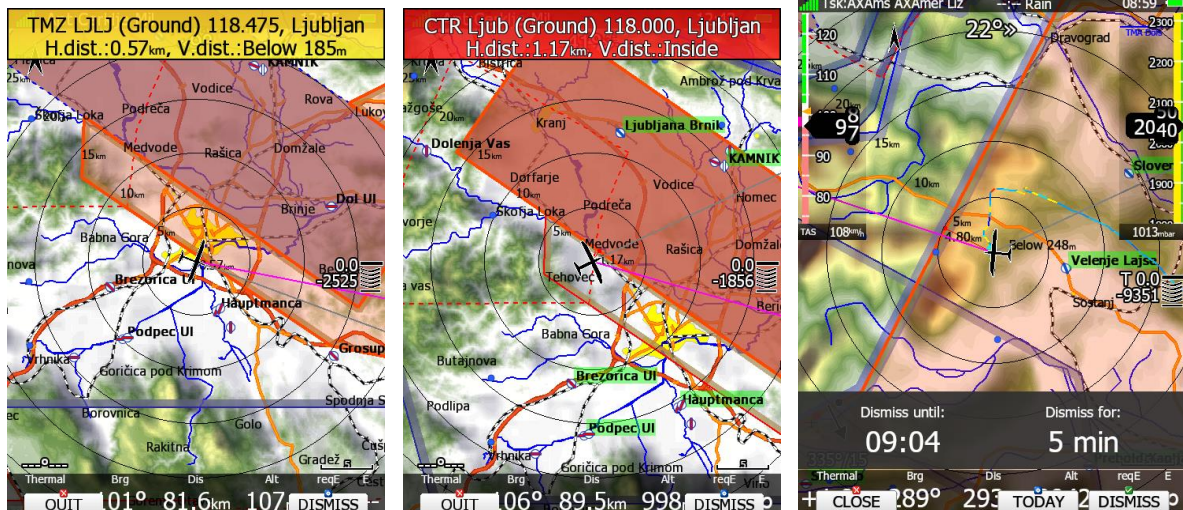

An Airspace warning will be raised in all modes and dialogues. A warning for an alarmed zone can be dismissed for a whole day, some minutes or just quit. **Quit** means that the message will disappear. Use **Dismiss for** spin to define dismiss time in minutes. This time will be shown in the lower-middle button after which the warning will be raised again. However, an alarmed zone will still be filled with transparent red colour and outlined with a thick line and the distance to the nearest point of the airspace zone will be shown. You can also change the dismiss value in flight from the dialog that follows clicking **Dismiss** button. On the bottom right corner of the screen you will see the number of minutes the warning will be dismissed for and on the bottom left the time when the warning will be shown again. To change the number of minutes, rotate the bottom right knob and click **Dismiss** again to confirm.

To prevent dismissing by mistake, check the **Confirm dismiss** checkbox and you will be always prompted to confirm dismiss for a particular airspace zone.

The **RESET** button will reset the status for all airspace zones.

5.1.10.2 Altitude Warning

Altitude is specified in MSL. Projection is calculated based on the 20 second average vertical speed and time which is defined in the **Time** item.

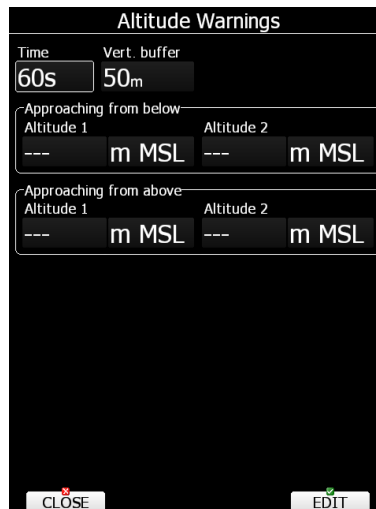

If the projected altitude is greater than the set altitude, an altitude warning will be raised. Altitude warnings will be raised in all modes and dialogues just as for airspace warnings.

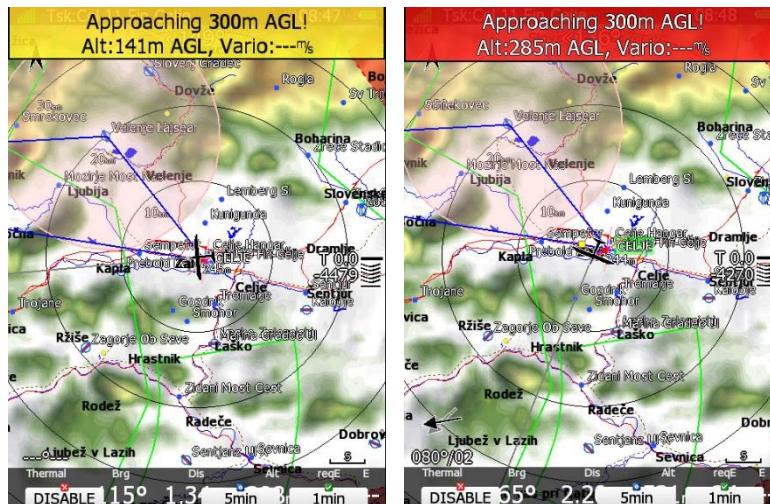

Altitude warnings can be dismissed for 1 minute, 5 minutes or disabled. Altitude warnings can be set for approaching from below a defined altitude or from above a defined altitude.

5.1.10.3 FLARM Warnings

FLARM warnings will be raised only when the system is receiving FLARM data from an internal or external FLARM module. Using this dialogue, the user can define which warnings will be shown and how they are going to be shown. There are two types of warnings:

Directed Warnings:

- **Traffic advisory** will be raised once a new aircraft is detected by FLARM.
- **Obstacles** warnings will be displayed when a collision with a ground obstacle is predicted. An obstacles file should be loaded.
- **Alert zones** are marked by ground stations to notify pilots of active parachute drop zones, RC/RPAS/UAS flying areas or similar.
- The **Low alarms, Medium and High alarms** combo box define alarm levels at which system will display collision warnings. **No alarm** means no alarm will be shown

Undirected Warnings:

- **Traffic advisory** will be raised once a new aircraft is detected by FLARM.

For each (Undirected and Directed Warnings) you can choose the alarm level separately.

Explanation of alarms:

- **Low alarms:** For distant FLARM targets the main unit can give a short or long message, just a beep or be turned off (19-25 seconds before possible collision).
- **Medium alarms:** For distant FLARM targets the main unit can give a short or long message, just a beep or be turned off (14-18 seconds before possible collision).
- **High alarms:** For very close FLARM targets the main unit can give a short or long message, just a beep or be turned off (6-8 seconds before possible collision).

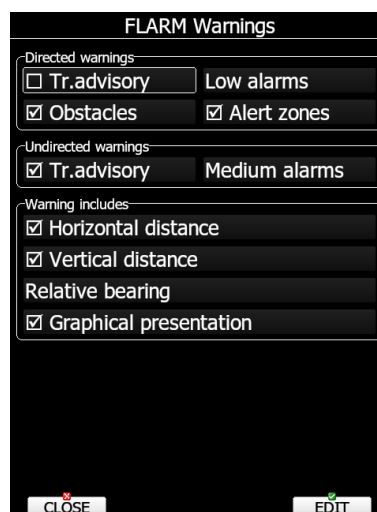

During competitions it is recommended to select Medium or High alarms, otherwise too many warnings will be displayed. Medium or High means that only the most important alarms will be triggered.

If the voice option is installed it is also possible to hear the horizontal and vertical situation of the current object. Uncheck appropriate items if you want to disable this part of the message. You can also define the way the direction to the FLARM object will be presented.

There are three options:

- **Relative bearing:** In this option direction will be given relative to the glider's nose direction (e.g. *Traffic 3' o clock*, which means traffic, is on your right side).
- **True bearing:** The direction is given as absolute direction (e.g. *Traffic from 330°*)

- **Relative/True bearing** is a combination of both methods. Relative bearings will be given when flying straight and true bearings will be given when thermaling.
- **Graphical presentation:** When this item is checked a graphical presentation of FLARM will also be shown when a FLARM warning is displayed.

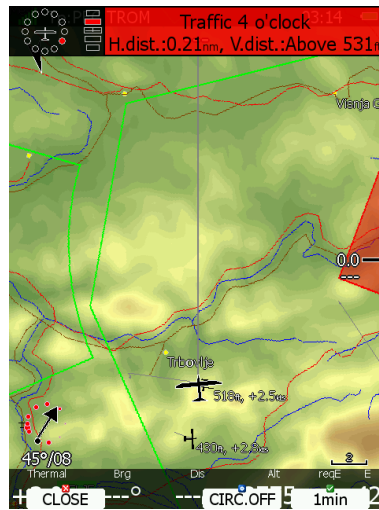

The picture above shows typical FLARM warning with graphical presentation and relative bearing of the object. Press CLOSE to dismiss warning, CIRC.OFF to dismiss for time of circling and 1min to dismiss all FLARM warnings for one minute.

5.1.10.4 Time Alarm Warning

Use this dialogue to define three independent time alarms that will be triggered at specified periods or one hour before sunset.

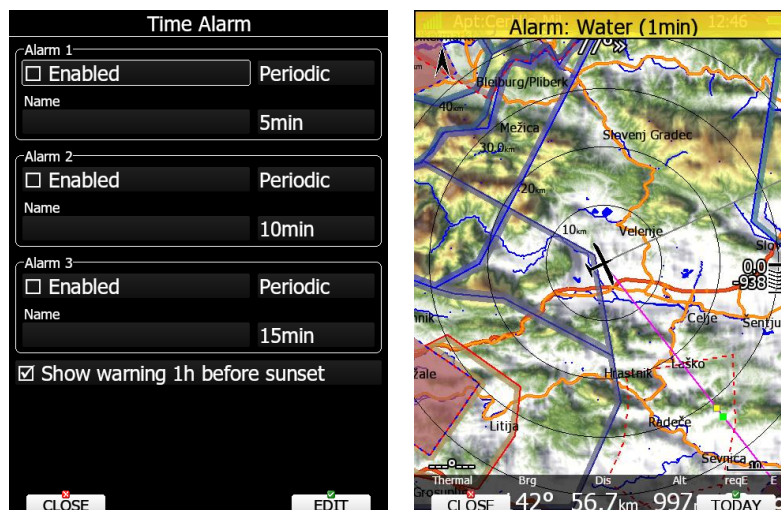

5.1.10.5 Gear Warning

The gear warning can be set. The warning will be triggered by AGL altitude below the entered value, when the following additional conditions are met:

- Indicated air speed below 126 km/h (35 m/s)
- Flat terrain below
- Negative vario (average below -0.5 m/s)

Gear warning will also trigger 5 minutes after take-off (when engine is off or when glider is no longer in the aerotow). Gear warning will be repeated only twice.

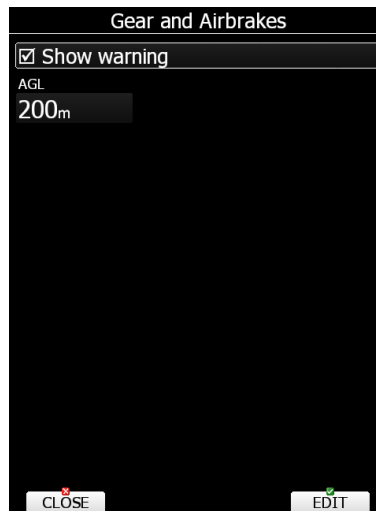

5.1.10.6 Waypoint Warning

The waypoint warning will be triggered at a defined distance from the selected waypoint.

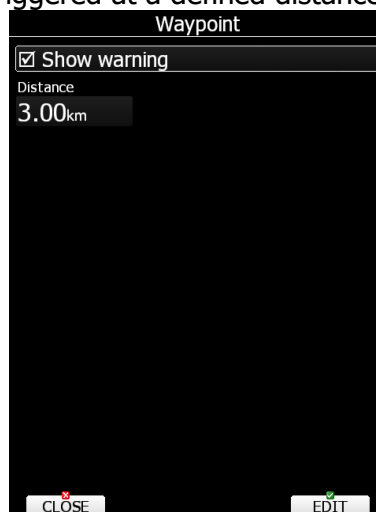

5.1.11 Units

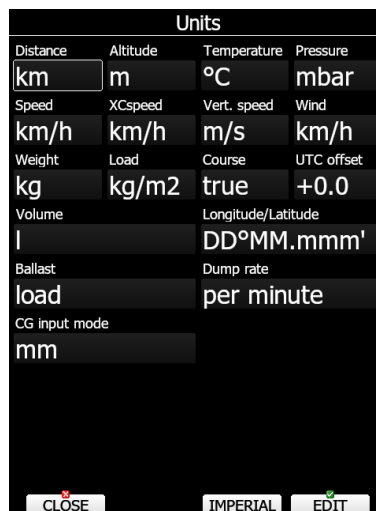

The lower-middle button will toggle all units between imperial and metric units.

Glider ballast can be entered as:

- **Load**, which is entered in kg/m² or lb/ft².

- **Weight of water ballast.** If this option is used the weights of the glider and pilot must be entered. Refer to Chapter 7 and chapter 5.1.2 for more details of how to enter glider and pilot weights.

5.1.12 Hardware*

Use this menu to define hardware properties such as total energy compensation, vario indicators layout, compass calibration, FLARM module settings, AHRS settings, Wi-fi module, NMEA output and data which will be exchanged between the rear and front display units. Some items may be greyed out when the selected option is not available.

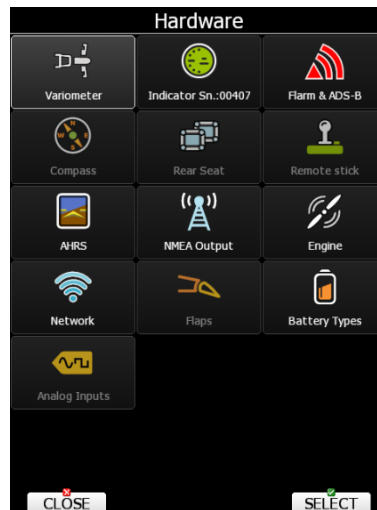

5.1.12.1 Vario Unit Settings – TE Compensation*

All settings in this menu are related to the glider and thus they do not depend on profile selection. In this manual dialogue description is given for firmware version 5.0 or higher with V5, V8, V9, V80 variometers. If an older version or older Variometer is being used, please refer to a previous version of this manual.

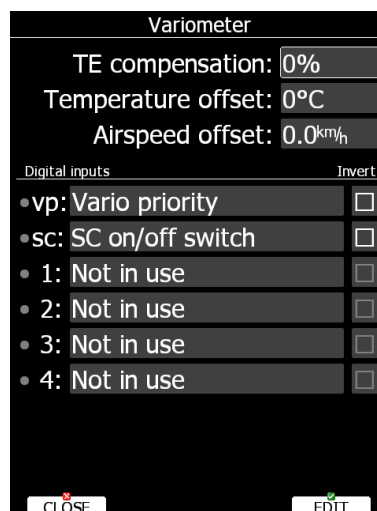

Total energy compensation, temperature offset, airspeed offset, and digital inputs are setup in this menu.

TE Compensation - Digital Total Energy Compensation

There are two ways by which the vertical speed can be corrected for total energy:

- Digital TE compensation based on speed changes with time,
- Pneumatic compensation with a total energy probe.

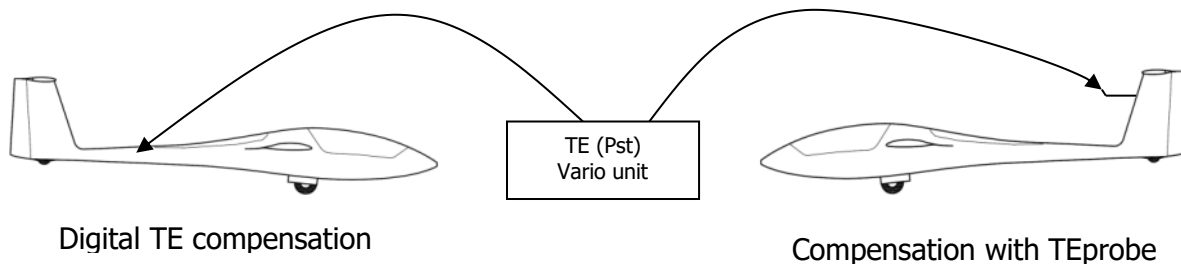

If the digital TE option is being used TE compensation should be set to 100%.



It is important to note that the method of TE compensation is set up when the instrument is installed by virtue of the pneumatic connections made to the TE and static ports. Changing the compensation type in the setup screen below WILL NOT change the method of compensation - the pneumatic plumbing must be changed first.



If the TE tube has been connected TE compensation should be set to 0%. The quality of the TE compensation depends entirely on the location, size and dimension of the TE tube. The installation must be leak-proof.



The two types of compensation are mutually exclusive, only one can be used at the time.

The digital TE compensation can be fine-tuned during flight using the following procedure. It is essential that this is only done in smooth air as it is not possible to tune the TE accurately in turbulent air.

Set TE compensation to 100%. Accelerate up to approximately 160 km/h (75 kts) and keep the speed stable for a few seconds. Gently reduce the speed to 80 km/h (45 kts). Observe the vario indicator during the manoeuvre. At 160 km/h the vario will indicate about -2 m/s (-4 kts). During the speed reduction the vario should move towards zero and should never exceed zero (slightly positive indications are acceptable). If the vario shows a climb the compensation is too low; increase the TE%; and vice versa. Try another "zoom" to assess the change and make further adjustments if necessary.

Digital TE compensation is only effective when the Pitot tube and static sources are co-located and the pneumatic lines to the instrument are approximately the same length. The best sensor to use is the combined Pitot/static Prandtl tube. If problems are experienced with the digital TE compensation the most likely cause is the glider's static source. The static source can be checked by plumbing the pneumatic tubes for digital TE compensation and then setting the TE: to 0%. In still air accelerate to approximately 160 km/h and slowly reduce the speed. Observe the vario indicator. If the static source is good the vario should immediately start to move to show a climb. If the needle firstly shows increased sink and then moves to a climb, the static source of the glider is unsuitable and there is no way to provide successful digital TE compensation. The use of a dedicated and accurate fin-mounted Pitot/static source such as a Prandtl tube might help.

Temperature Offset

The system is supplied with an external outside air temperature (OAT) sensor. With the offset setting it will correct static errors of temperature measurement.



There is another input called VARIO PRIORITY. When this input is activated by grounding the appropriate wire the unit will change over to Vario immediately. This input wire is set open (not grounded) as a factory default on delivery.

Airspeed Offset

Some gliders have a significant difference between calibrated airspeed and indicated because of imperfect static ports (e.g.: Cirrus Standard). Airspeed has an effect on the wind calculation. It is possible to define an airspeed offset to improve wind calculation.



The vario indicator will ignore this setting and shows uncorrected airspeed.

Digital Inputs

The V9 and V5 variometers have six programmable digital inputs. Two of them are special and are labelled VP and SC (since August 2015 SC is no more wired via cable); others are labelled with IN1, IN2, IN3 and IN4 on the V5/V9 cable-set. See the Installation Manual for more details on the vario unit wiring diagram.

In the current version digital input can represent the state of following actions:

- **SC on/off switch** is used to change between SC (cruise) and climb mode using on/off switch on the remote stick or magnetic switches on flaps. Use the **invert** check box to invert the working of the switch.
- **SC flap switch** shall be used, when user is changing between cruise and climb mode using flaps.
- **SC toggle button** is used to change between SC (cruise) and climb mode using a push button on the remote stick. Use the **invert** check box to toggle when button is pressed down or released. To configure SC toggle button, go to Setup-Hardware-Remote stick. See also Chapter 5.1.12.9
- **Vario priority** is used to instantly change from SC (cruise) to climb mode as long as the push button is pressed. It always has a higher priority, so it will always switch.
- **Toggle audio source** will toggle between HAWK audio source and TE vario audio source.
- **Gear down and locked** should be connected to gear only.
- **Airbrakes locked** should be connected to airbrakes only.
- **Gear and airbrake** is used when you already have an old style of gear warning, where gear and airbrakes are connected together in one loop.
- **Water ballast open** is used to automatically calculate amount of dropped water from main tank.
- **Tips ballast open** is used to automatically calculate amount of dropped water from tips tank.
- **Tail ballast open** is used to automatically calculate amount of dropped water from tail tank.
- **Event button**
- **Canopy locked**
- **Radio PTT active** should be wired parallel to the PTT button and it will mute the vario sound whilst transmitting over radio.
- **Engine failure**
- **Low fuel**

- **Flaps up**, used for automatic flap control to move flaps up.
- **Flaps down**, used for automatic flap control to move flaps down.

Digital input shall be wired via a switch to ground and it shall open or close when the selected action is performed. A green light will light.

If necessary, check the **Invert** check box to reverse the operation of digital input.

Once digital inputs are connected the system will warn the pilot if airbrakes are open on take-off and when gear is not locked prior to landing.



Instead of using a magnetic switch on flaps to toggle between SC (cruise) and climb mode you can also use a flap sensor for this operation. See chapter 5.1.12.13.



There is another input called VARIO PRIORITY. When this input is activated by grounding the appropriate wire the unit will change to Vario immediately. This input wire is set open (not grounded) as a factory default on delivery.



In case if Becker radio, PTT line on input for "mute vario" can be only used if there is a diode wired in the line, otherwise Becker radio stays in a transmit mode.

5.1.12.1.1.1 SC Configuration with the NEW TYPE (from 2016) Remote Stick

The new LXNAV remote stick comes without the standard SC cable and VP cable, however the function is still available.

With the new stick, there is no more need to solder these wires to the vario wiring loom.

The SC function is programmable through the LX80/90xx (version 5.x).

Please make sure that none of the inputs is set to

"SC on/off switch" or "SC toggle button".

Configuration table for all SC switch options for new and old sticks:

Remote stick type	SET: Input (SC) setting
LX NEW remote without SC cable	Not in use
Old LX remote with SC cable (before 8/2015)	»SC toggle button«
Old remote stick with SC switch	»SC on/off switch«
Using flap sensor	Not in use
Using magnetic flap sensor (AS style)	»SC on/off switch«

5.1.12.1.1.2 Conditions to Trigger a GEAR Warning

There are 3 options when the GEAR warning is triggered.

If both Inputs: GEAR and AIRBRAKES are connected to the system, the warning will be triggered under following conditions:

- When altitude is below 200m
- When Airbrakes are opened

If only AIRBRAKES input is connected the warning will be triggered when:

- Altitude is below 100m

If no inputs are present the following conditions must meet to trigger the warning:

- Indicated speed below 126km/h
- AGL below the AGL setting (setup->warnings->gear)
- Negative Vario
- Flat terrain below

5.1.12.2 Vario Indicator Setup*

The vario indicator is always part of the vario unit. However, an unlimited number of secondary vario indicators can be connected to the system using the RS485 system bus. There are three different types of vario indicators: the **I9 vario indicator**, which is standard part of V5/V9 Variometer, the **I8 vario indicator** or **I80 vario indicator**, which is built-in part of V8/V80 Variometer and the old **LCD or USB-D vario indicator**.

The LCD vario indicator and USB-D type of indicator are setup through menu **LCD Indicator**, whereas other, more modern vario indicators have their own menu item identified by the serial number.



LXNAV is highly recommending upgrading old LCD or USB-D type of vario unit to latest technology vario unit. Please contact your local dealer or LXNAV for more details.

5.1.12.3 Indicator I9*

The **I9 indicator** has a mechanical needle and a colour screen with 320x240 pixels resolution on which user selectable data are displayed.

Each I9 indicator is identified by a serial number, which is also displayed on the hardware menu. Therefore, literally unlimited number of vario indicators can be connected to RS485 bus and each of them can be setup separately.



A description of the indicator is shown on the following picture.



The **Mechanical needle** displays the vario, netto, relative or speed to fly value. It can be setup separately for climb mode or cruising mode. The printed scale can be chosen in range from -5 to 5 or from -10 to 10. Within software the range can be set to 2.5, 5, 10m/s or 5, 10, 20 kts or 500, 1000, 2000 fpm.

The **Upper number** and **Lower number** can be configured as average vario, time, flight time, task remaining time, netto value, outside temperature, thermal average, indicated airspeed, true airspeed, current altitude, distance to goal, arrival altitude, last 60 minutes speed, altitude in feet, flight levels, voltage or average netto. It can be setup separately for climb mode or cruising mode.

Speed to fly bar symbol is indicating which speed you should fly according to the current MacCready setting, sink rate and speed. One arrow means 10 units of speed faster or slower. Up red arrows mean fly slower and down blue arrows mean fly faster.

Red diamond symbol can show average vertical speed, netto or current g-load.

Blue arrow symbol shows the current MacCready value.

Green T symbol represents the last thermal average value ->**Thermal**

White bar displays the arc between the minimum and maximum vertical speed value in last 20 seconds in white colour or minimum and maximum g-load in red colour, depending on settings.

FLARM warnings can also be shown on the indicator if this box is ticked. By pressing **DEMO**, you can see how the warning is displayed.

Press **RESET-G** button to reset the g-meter.



An innovative feature of vario system is the upgrade method. Firmware for the vario unit can be easily upgraded by the customer via a SD card. See Chapter 10 for more details.

5.1.12.4 Indicator I8/I80/V8/V80

The **Indicator I8/I80** is without a mechanical needle. The I80 features a 3.5" colour screen with 320x240 pixels resolution; the I8 features a 2.5" colour screen with 320x240 pixels resolution. User selectable data are displayed on the screen and the needle is drawn. Each indicator is identified by a serial number, which is also displayed on the hardware menu. Therefore, literally an unlimited number of indicators can be connected to the RS485 bus and each of them can be setup separately, however only one vario unit.

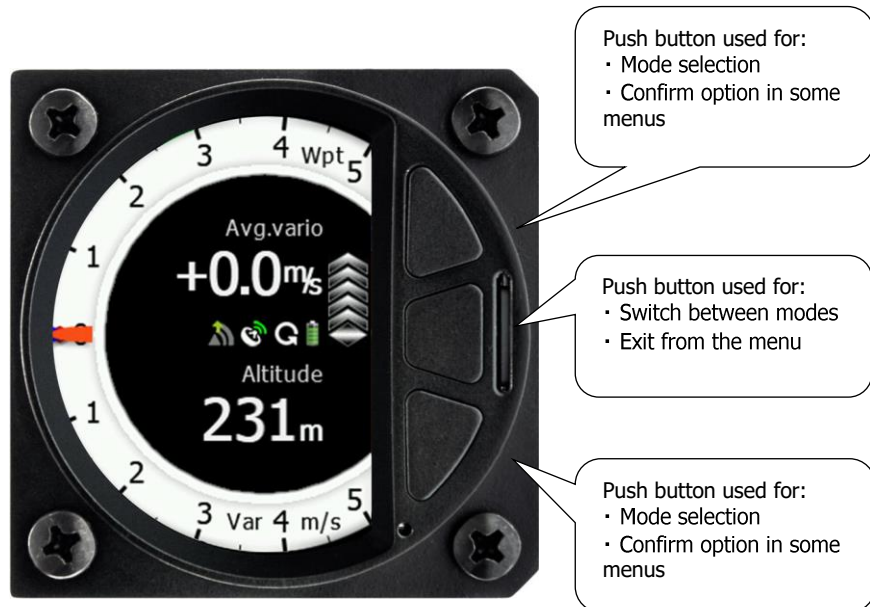

The Indicator basic screen is split into two parts: a white ring with a needle and the vario scale. In addition to the needle, a blue MacCready triangle, a green thermal average T and a red diamond for 20 seconds average are shown. In the centre four user-customizable numbers are displayed. When the middle button on indicator is pressed the display will toggle between numeric display, AHRS mode, wind page, FLARM radar display and Thermal assistant mode. After a long press on the middle button you can enter the SETUP menu.

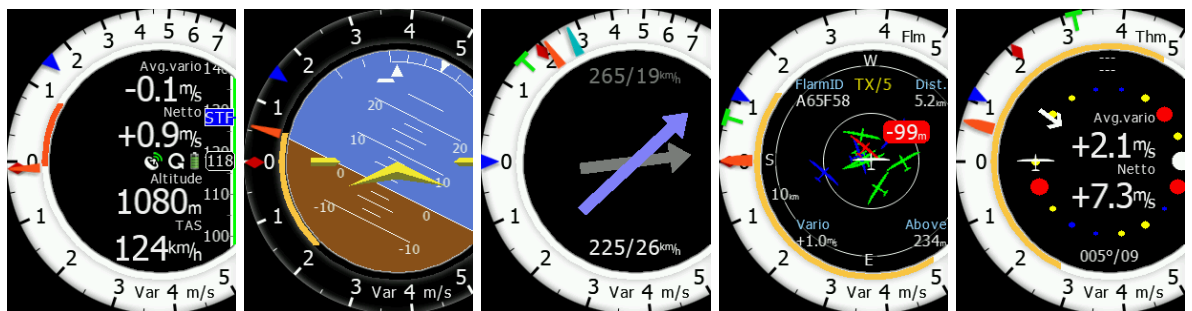

Indicator Setup on the LX80/90xx Device

The numeric screen can be also set on the main display unit.

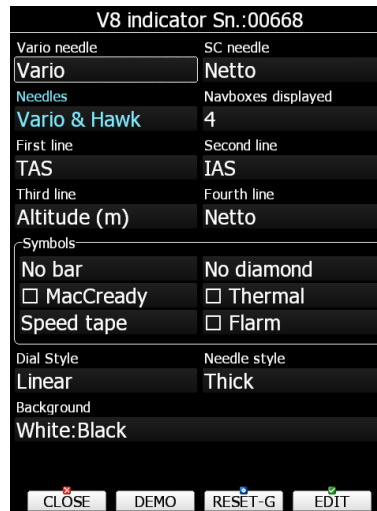

The Vario or SC needle can be set to: Vario, SC, Netto or Relative.

When **HAWK** option is installed, user can define, if he wants to see only **HAWK** (blue) needle, **TEK vario** (red) needle or both needles.

Up to four user customizable numbers (navboxes) can be configured for each line separately.



When using **HAWK** option it is recommended to set SC needle to Netto.

They can be configured as:

Average vario, Time, Flight time, Task remaining time, Netto value, Outside temperature, Altitude, Distance to goal, Arrival altitude, TAS, last 60 seconds speed, Altitude in ft, Flight level, Thermal average, IAS, Voltage, Average netto, Height, Total altitude and Altitude IGC. When **HAWK** option is available following navboxes can also be selected: **HAWK** Average netto, **HAWK** Average netto, **HAWK** sideslip, **HAWK** AOA



Navboxes set in the first and second line are also shown on the Thermal mode page.

Under Symbols section a layout can be configured. The first row defines a yellow bar on the vario. It can be set to Min/Max vario, G-meter, or No bar. A red diamond can be set to Average vario, Netto vario, G-meter or no diamond. A Blue diamond is defined for MacCready setting, which can be enabled or disabled. Thermal assistant ->bubbles can be enabled, if Thermal is checked. A Side bar can be set to STF bar, Flaps tape, Speed tape, Flaps & Speed tape or to no bar. To see FLARM objects on the screen you need to check FLARM option.

Number of navboxes can be set from 1 to 4 navboxes.

Vario scale can be linear or non-linear.

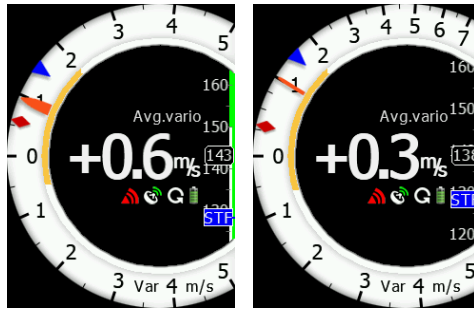

Background theme (colour style) of the vario can be set to:

- White:Black
- Black:Black
- Black:White
- White:White



Needle style (red cursor) can be set to thin, medium or thick.



All settings can be tested by pressing the **DEMO** button. G force can be reset via the **RESET-G** button.



V8/V80/I8/I80 do not change the screen when toggling between cruise and climb mode.

Indicator Setup on the Indicator

All settings can be set on the vario/indicator device in the SETUP menu.



In setup menu it is possible to setup indicator settings, FLARM settings, Thermal assistant, Graphics, Display settings, Files, Password and check the about screen.

5.1.12.4.1.1 Indicator

Number of navboxes on the numerical page can be set here. Minimum is 1, maximum is 4 navboxes. Red cursor -> Needle style can be set to thin, medium or thick. Needle range can be set to Linear or Non-linear. **Colour style – Gauge: Inner**

With this dialogue you can change the background colour for the vario gauge (Outer ring) and the background of the information circle within the gauge. You have the choice of the following:

Gauge	Inner
White	Black (default)
White	White
Black	White
Black	Black

5.1.12.4.1.2 FLARM

FLARM alarms can be enabled or disabled. The warning dismiss time can be set from 0 to 120 seconds.

5.1.12.4.1.3 Thermal Assistant Mode

There are three options for the thermal assistant: Auto Span, MacCready and Average Vario.



The colors in the thermal assistant indicate below average (blue), average (yellow), above average (red) and the strongest point of thermal (white).

- If Auto Span is selected then the Thermal Assistant will use the average performance of the current circle to calculate the below, average and above average climb and indicate accordingly i.e. red bubbles for strongest lift and blue dots for weakest lift or sink.
- If MacCready is selected, then the Thermal Assistant will use the current MacCready setting to show rate of climb below MacCready and above the MacCready setting.
- If Average Vario is selected then the Thermal Assistant will use the average vario for the flight to show the rate of climb below average vario, average vario and above average vario.

Switch to Thermal Assistant Mode

It will change to the Thermal Assistant mode by the 2 methods:

- SC to Vario mode switch
- When circling (auto – when you start circling)

It can be also disabled, in this case there will be only 2 navboxes.

5.1.12.4.1.4 Graphics

Map, FLARM and Theme graphics can be defined in this menu.

5.1.12.4.1.4.1 Map

Option to set Track Up or North Up.

5.1.12.4.1.4.2 FLARM

Traffic on Map

Check the dialogue box to display FLARM objects on the screen.

Select Target on Map Only

There will be only the selected target on the map.

Colours

Colours can be set for the following:

- Glider Above Colour
- Glider Below Colour
- Glider Near Colour
- Selected target Colour

Label Text

On the map it is possible to show additional, related text next to the FLARM object. This option can be set to None, Competition sign, Climb rate and Relative vertical.

Active Timeout

Adjusts the time a glider symbol remains on the map after it has last been seen by the FLARM.

Inactive Timeout

Adjusts the time for inactive gliders on the FLARM target list. Inactive gliders are gliders where the FLARM signal has been lost for a period longer than the Active timeout. The targets become inactive and remain only in the FLARM target list for this time.

Draw Line to Selected Target

Check this option to enable or disable a line drawn to a selected FLARM target.

Draw History

Select if a trail is to be drawn behind FLARM targets to show where the targets have been.

Plane Icon size

To adjust the pixel size of FLARM targets.

5.1.12.4.1.5 Display

Automatic Brightness

If the Automatic Brightness is checked, then the brightness will be automatically adjusted between the minimum and maximum parameters set. If the Automatic Brightness is unchecked, then the brightness is controlled by the brightness setting.

Minimum Brightness

Use this slider to adjust the minimum brightness for the Automatic Brightness option.

Maximum Brightness

Use this slider to adjust the maximum brightness for the Automatic Brightness option.

Get Brighter In

The user can specify in which time period the brightness can reach the required brightness.

Get Darker In

The user can specify in which time period the brightness can reach the required brightness.

Brightness

With the Automatic Brightness unchecked you can set the brightness manually with this slider.

Night Mode Darkness

Set the percentage of the brightness to be used after a press on the NIGHT mode button.

5.1.12.4.1.6 Files

The Files menu allows you to upload FlarmNet database.

5.1.12.4.1.7 Password

There are several system passwords which run specific procedures as listed below:

RESET TO FACTORY DEFAULT	00666
AUTO ZERO (Airspeed)	01043
Align Gyros	01045
REPORT TO SD CARD	00111
FORMAT INTERNAL MEMORY (all data will be lost)	32233



Passwords listed above are for the use in indicator ONLY. System passwords for LX80xx/90xx device can be found in chapter 5.1.17.

To enter the code, you must select the number and press CHAR>>. Repeat the procedure until you have written all the numbers. Press OK after entering the last number.

5.1.12.4.1.8 About

Information about software versions of the indicator's part and the sensor box.

Numerical (navbox) Mode

By default, there are 4 Navboxes: Average Vario, Netto, Altitude and True Airspeed. In addition, the central line shows the status of the FLARM, GPS, Cruise/Climb and battery.

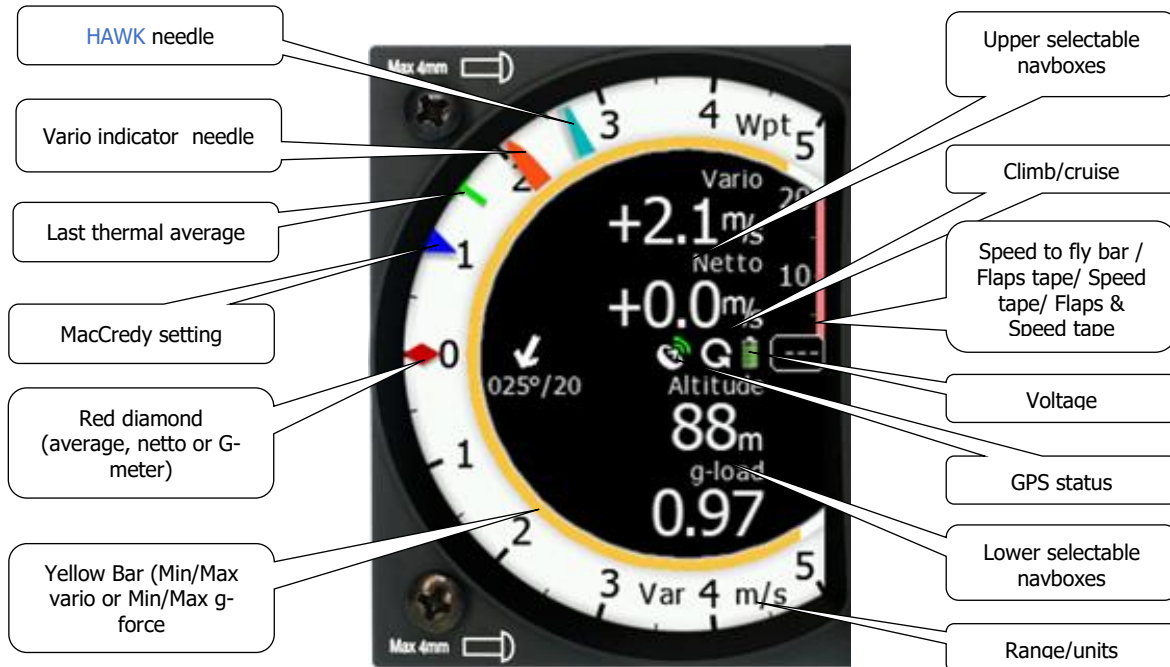

- The Vario **Needle** can display: the Vario, Netto, Relative or Speed to fly value (Setup->Hardware->Indicator). The scale can be chosen in the range of +/- 5 +/-10 or +/-20 (in SETUP-> Vario Parameters). Within the software the range can be set to m/s, kts, km/h, mph or fpm (in Setup, Units, Vertical speed)
- The **HAWK needle** will show same parameter as Vario needle but calculated with **HAWK** system. To learn more about **HAWK** setup see chapter 8.7.5.
- The **Speed to fly bar symbol** indicates which speed you must fly relative to the current MacCready setting, sink rate and speed. One arrow means 10 units of speed faster or slower. Up red arrows mean fly slower and down blue arrows mean fly faster. It can be also set to **Flaps tape, / Speed tape / Flaps & Speed tape**
- The **Red diamond** symbol can show Netto, Average Netto, Average vertical speed or G-force.
- The **Blue arrow** symbol shows the current MacCready value.
- The **Green T** symbol represents last thermal average value.
- The **Yellow Bar** can show Max and Min values of vario over defined time (average vario) or G meter (over whole flight).
- The **Flarm Status** symbol indicates the presence of a FLARM unit (grey). If the FLARM receives any data from other FLARM units, the symbol becomes red. A grey icon with a green or blue arrow might appear if an external Flarm is connected. This indicates communication from the external Flarm by downloading flight to the external device (SD/USB) or when updating obstacles, diagnostics and also for the internal consistency check



- The **GPS** symbol is green when the GPS status is OK, and red when GPS status is bad. If GPS data is not detected, the symbol will disappear.
- **Cruise/Climb** symbol shows in which mode variometer is operating. When audio source for this mode is **HAWK**, it will be coloured blue.

All these parameters can be set/adjusted on the LX80/90xx device via: SETUP->HARDWARE->"V8/V80/I8/I80" indicator SN:xxxxx.

AHRS Mode

To activate AHRS an activation code must be purchased.

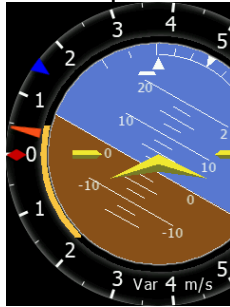

The AHRS option can be activated on the LX80/90xx. For more information refer to Chapter 5.1.12.10.



The Pitch offset can be adjusted in the AHRS menu on the LX80/90xx device.



For competitions the artificial horizon can be disabled on the LX80/90xx device in the AHRS menu. When the artificial horizon page is active a BFION event is written to recorded flight for verification purposes.

Flarm Radar Display

Flarm Mode will display a map of the relative positions of FLARM targets that are within range. When you press either the upper or the lower button, you can see focus on ID or zoom. Press on the middle button will move focus from one to the other.

Pressing the up/down (upper/lower) buttons, when focus is active, will change the zoom level or switch between the active targets.

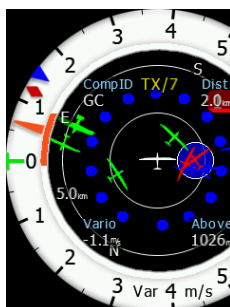

Data from a selected FLARM object can be seen in 4 corners, such as: FLARM Id, Distance, Vario and Relative altitude (Above / Below). There is also an indication of how many FLARM objects are present displayed as: TX/number.

Representation of Flarm objects are as follows:

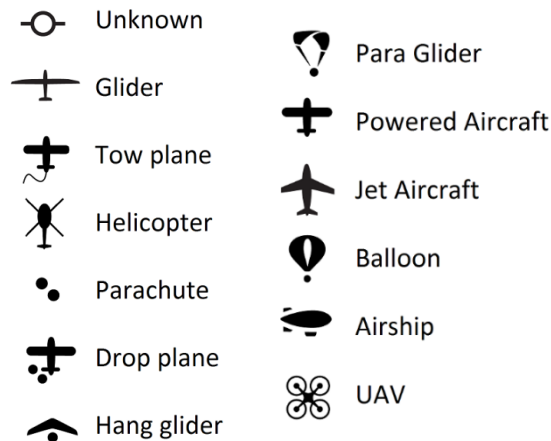

5.1.12.4.1.9 FLARM Warnings

Regardless of which Mode you are in, if a FLARM target triggers an urgent (third warning level) or important (second warning level) warning then the screen will change to the FLARM warning mode automatically.

Extract from the FLARM manual:

Warnings are given in order of the time remaining before a potential collision, not the geometrical distance. The first warning level for another aircraft or an obstacle is delivered at less than 19 - 25 seconds before the possible collision; the second warning level is delivered at less than 14 - 18 seconds before; the third level at less than 6 - 8 seconds before.

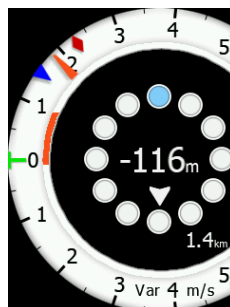

The central number and chevrons indicate if the FLARM target is below or above and by how many meters/feet. The number in the bottom right indicates the range in meters/feet. The numbers are related only to the closest or the most dangerous target.

Thermal Assistant Mode

The Thermal Assistant mode displays a graphical representation of your location within the thermal. If you are thermaling to the left there will be an aircraft symbol on the right of the ring of bubbles and the bubbles will appear to rotate clockwise (towards the symbol of the glider). If you are in a right-hand thermal there will be an aircraft symbol on the left and the ring of bubbles will appear to rotate anticlockwise (towards the symbol of the glider). Large red bubbles indicate the strongest lift within the thermal and small blue dots indicate the weakest lift or sink within the thermal. Yellow bubbles indicate lift equal to your

MacCready setting, average thermal or average climb rate depending on your preferred setting. The point of strongest lift is indicated by a white large bubble.



You can use the thermal assistant to visually determine which part of the thermal has the strongest lift and adjust your turn accordingly to manoeuvre the glider in the direction of the strongest lift and away from the weakest lift or sink.

The two Navboxes within the Thermal Assistant Mode can be configured on the LX80/90xx in the first and second navbox lines.

5.1.12.5 Bridge 232*

Bridge 232 is an external device which is sold separately and is used to output NMEA data or to connect a radio or transponder to the system.

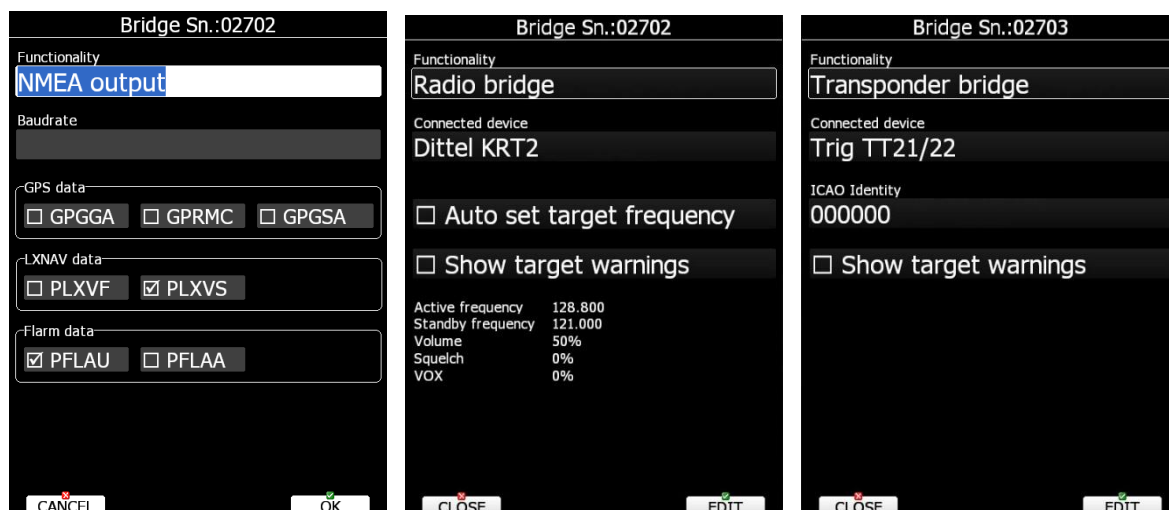

See installation manual for details on wiring of Bridge 232.

Once bridge 232 is plugged into the 485 bus, Bridge Sn.:SNxxxx will appear in the Hardware menu.

First functionality must be defined. Based on functionality, the dialogue will change and display related items for selected functionality.

In **NMEA output** define the baud rate at which NMEA sentences will be transmitted. Select the desired NMEA sentences. NMEA data is exactly as described in Chapter 5.1.12.12.

Radio bridge is used to operate a radio through the main display unit. First the type of connected radio must be selected. At the moment the following types are supported: KRT2, Trig TY91/92, ATR833, Becker 620X, ACD57. Support for other types is in progress. Please consult LXNAV for more details.

Check **Auto set target frequency** if you want to automatically select frequency when a new target is selected in navigational mode. Ticking **show target warnings** will trigger warnings generated from the device (example: radio is too hot).

Transponder bridge can operate the transponder with the main unit. Supported transponders are: Becker BXP6402 and Trig TT21/22.

ICAO code, ID and SQUAWK could be set and sent from the LXxxxx device to the transponder. It can also show target warnings from the transponder.

ACD57 display

ACD57 display can be connected to the device as well. Functionality must be set to **Multifunctional bridge**, connected device to **AirAvioni.ACD57**. The other settings are the same as in chapter 5.1.12.5.



5.1.12.6 FLARM*

On the FLARM setup page information about built in or external FLARM are visible. Information like serial number, selected frequency, firmware version and database versions are shown. Serial number will appear after you leave instrument running for a few minutes.



Press the **CLEAR** button to delete all data on the FLARM module. This will also remove the obstacle database.

If the FLARM module is built in the user can select the operation mode. There are three different operational modes available:

- **Power OFF** - FLARM unit is switched off.
- **Power ON** - FLARM unit is switched on.
- **Stealth ON** - FLARM unit works in stealth mode. Other FLARM units will not receive altitude and vario information concerning your glider (only a dot will appear on their instruments). For collision warnings this mode has no influence. You will also see other traffic only as a dot, without altitude and vario data.

If there is no FLARM module built into the main display unit instead of the operation mode combo box **Baud rate** selection will be displayed.

Freq shows selected frequency depending on the continent where system is located. The FLARM Frequency is automatically updated based on the current continent.

Port defines the serial interface through which FLARM data are being received.

- **Internal** is the default setting and indicates that the internal FLARM will be used, if this option is installed.
- **Ext. (Colibri)** (only on LX8000 old model) – Use this mode when you want to receive external FLARM data through the Colibri port on back side (for example, if a TRX1090 is connected to the LX8000.)
- **Ext. (PC)** – Use this mode when you want to receive an externally connected FLARM via the PC port.
- **Flarm** – port is available on selected devices only and means that FLARM input will be via the port labelled FLARM.
- **GPS** – port is available on simple type of devices only and means that FLARM input will be via the port labelled GPS.



Classical external FLARM can be updated through the main device. PowerFLARM can be updated only via a USB stick.



When the FLARM is as an external FLARM unit, it might take few minutes to read and show the data (device ID etc...) after switching ON the main device.

Refer to the installation manual and Chapter 10.1 of this manual for more details.

Device ID shows the FLARM unique ID which is transmitted to other FLARMS. User can change that ID. The ID is normally changed if we have XPDR on board. In this case we set ID to XPDR ICAO ID. ICAO ID cannot be changed while airborne.

Flarm & ADS-B

Mode: Internal Device ID: D0010C

Aircraft type: Glider/motor glider

Competition mode

Reduce warnings

Send declaration

No tracking

PCAS	ADS-B
Horizontal range: ---km	Horizontal range: ---km
Vertical range: ---m	Vertical range: ---m

ADS-B warnings

Capabilities: DP2, BARO, HNR Licenses: PRE, HNR

CLOSE CLEAR EDIT

Competition mode is intended only for competitions. If this mode is enabled the pilot will see a reduced number of FLARM warnings while circling on the navigational screens. The competition mode status is recorded in the IGC file and can be checked during scoring. Range of view is also limited.



If you are flying in a competition, it is sufficient to turn on **Competition mode**. However, if you do not want other aircraft to see you, you should switch mode to **Stealth ON**.

Reduce warnings will significantly reduce FLARM warnings. Use this option if you are flying in gaggles or areas with high density of other aircraft.



We recommend you sign in at FlarmNet.org. This is free of charge. Registering with FlarmNet allows others to see you not only with Device ID but also with your contest number and name. Refer to Chapter 6.2.1.9.

The **Send declaration** check box is available only when an external FLARM is connected. Check this option if you want task declarations to be automatically transferred to FLARM.

No tracking will disable tracking mode. If set, receiving ground stations do not process or store position data of aircraft. For example, you will not be visible on OGN.

PCAS (non-directional traffic) horizontal and vertical range can be set here. If vertical distance is set to for example 2km, you will see traffic that is 2km above and 2km below your glider. Next to it to the right the same can be done for **ADS-B** (Automatic Dependent Surveillance-Broadcast) traffic. If you scroll all the way to the maximum value range will be set to "Unlimited". Same can also be done by pressing "Unlimited" button that appears once you start editing value.

Check **ADS-B Warnings** to enable warnings for ADS-B traffic.



You can also see your FLARM **serial** number, **version**, **capabilities**, **licenses** and **obstacles** loaded (if they are loaded).

Capabilities abbreviations:

- DP2 – second data port
- OBST – device can give obstacle warning if database is installed and license is valid
- RFB – Second radio channel for antenna diversity

Licenses abbreviations:

- RFB – activation of second antenna
- PRE – activation of pressure sensor functionality
- L6S – Activation of LEA-6S-GPS module



After downloading a RFB you can install it via Setup->Password->insert 89891 then selecting the appropriate file.



The FLARM internal number can be seen in the last row, next to the current SW version. The internal number will not appear immediately after powering on the main device, it can take up to 5 minutes. The internal FLARM number can be also seen within the IGC file.



PCAS and ADSB configuration is possible only for integrated ADSB modules. It will not work with TRX1090

5.1.12.7 Compass*

When a compass is connected to the system use this menu to perform calibration. Before calibration, please make sure that compass is installed properly. Refer to the compass installation manual for further information.



It is very important that the compass is installed away from power cables, other compasses, speakers and all other magnetic components in the aircraft. Keep maximum possible distance to such components (at least 30cm).

The compass will be enabled if the check box **Enable compass** is ticked. If you would like to perform in-flight calibration, check **Enable in-flight calibration**. It is not recommended to do in-flight calibration in very turbulent conditions.

There are four steps necessary before compass calibration is ready. These steps are: factory calibration, installation check, alignment of compass and user calibration. It is necessary that all four checks passed to make compass working. In the next pages each step will be described. Factory calibration will be described as last one as all newly delivered compass should be factory calibrated. For existing compass, it is recommended to re-do factory calibration

Installation check

Once compass is properly installed, you may start installation check. Compass screen will look like the one on the picture below.

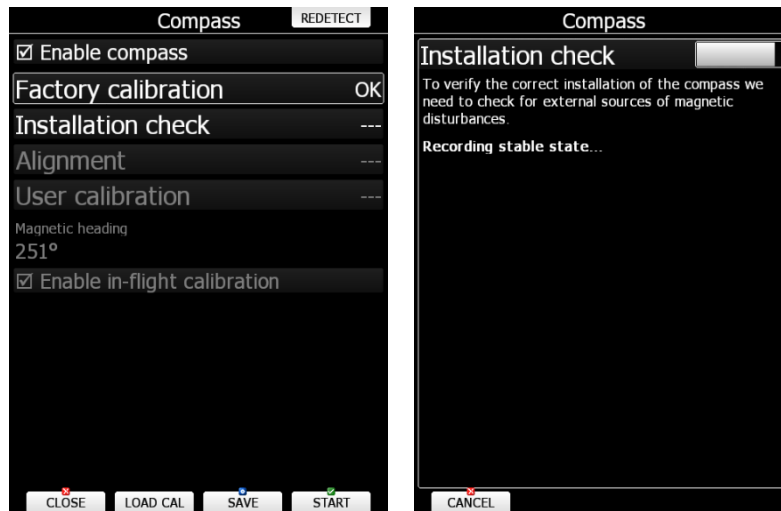

Select Installation check item. You should be seated inside glider with canopy closed and all avionics on as when flying. Glider should be at still and moving. Press START button and installation check will start.



If some item is unavailable on your glider, just wait until timeout for this item passes. Current compass reading should always remain within yellow circle. If it will move outside it, it means that compass location is not ok and compass should be relocated. Once installation check is successfully completed, you can move to next item, which is alignment.

Alignment

During flying compass is reading roll and pitch from sensor box inside your vario unit (V9, V8 or V80). It is important that compass modul and sensor box unit are aligned to some extent.

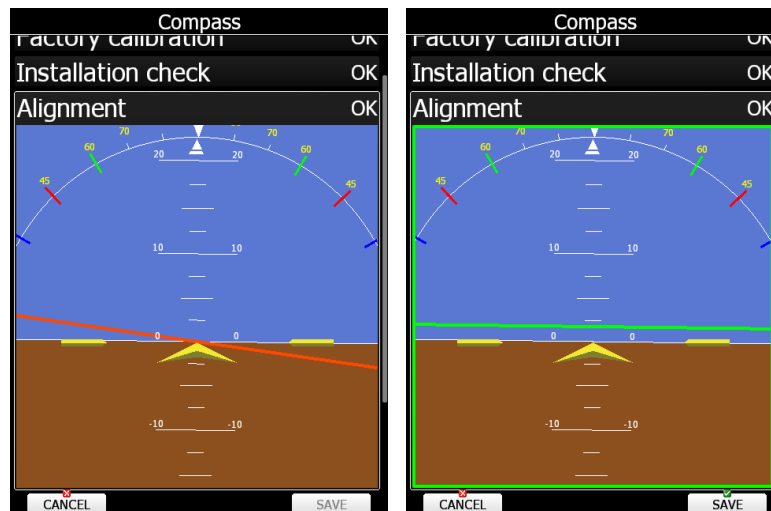

Seat in the cockpit and close the canopy. Wings should be levelled. Press align button to start alignment process. AHRS display with red or green line will be shown. Red or green line represents compass roll and pitch. Move compass so long that you will get green line and green rectangle. Press SAVE button. Compass is now aligned with sensor box.

User calibration

Once alignment process is finished compass is ready for user calibration. You will need one assistant to preform user calibration. Seat in the glider and close the canopy. Press align button to start user calibration. Wings should be levelled. If wings are not levelled enough, you will see red rectangle. Your assistant should hold a wingtip and start walking so that glider will start rotating.

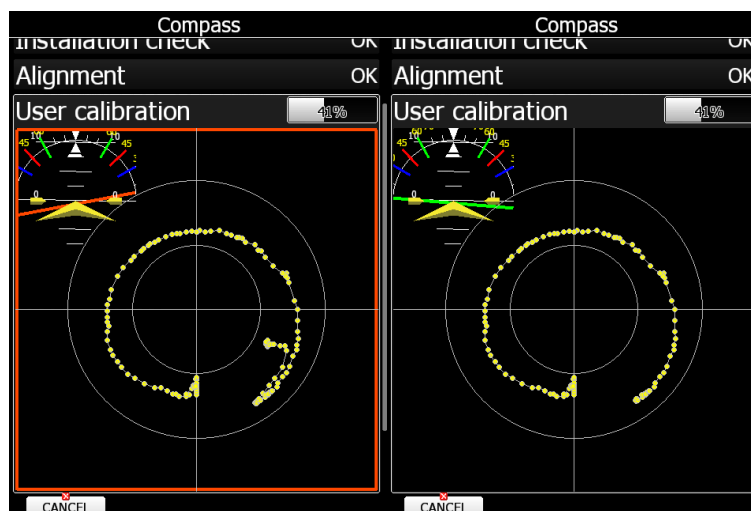

You should see yellow dots will start forming a circle, which should be more or less centred. Keep rotating glider until progress get to 100%. Once progress is at 100%, user calibration is finished. If you do not see any progress change during rotation, you should increase glider rotation speed. If there is still no progress, compass location might not be good enough. Send us a picture of screen and we will try to assist you.

Once user calibration is successfully finished your compass is ready for usage.

Factory calibration

Factory calibration eliminates hard and soft iron inside the compass module it self. All delivered compasses are already factory calibrated therefore there is really no need to perform this calibration by user.



Factory calibration will erase all calibration parameters of compass. Use factory calibration only, if you are really familiar with it. Otherwise compass will be unusable and must be returned for non-warranty service.

Remove compass from a glider and find a location without any magnetic. Select factory calibration item and press START to begin factory calibration. A message dialog will be shown, to confirm that you have removed a compass. Now you are ready to perform factory calibration. A sphere created with grey dots will be shown. Move your compass in various directions to see progress bar moving. Once progress bar reaches 100%, initial phase of factory calibration is finished any you are ready to move to next phase.

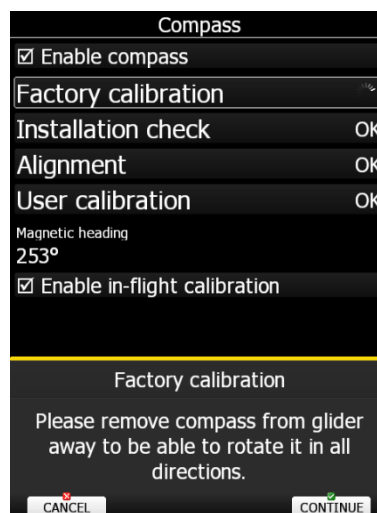

Dots will be coloured red. Idea now is to change colour of all red dots to grey colour. Move compass in various directions to colourize all the dots. If you have difficulties to do, ask your kids to help you. They will like to play this game.

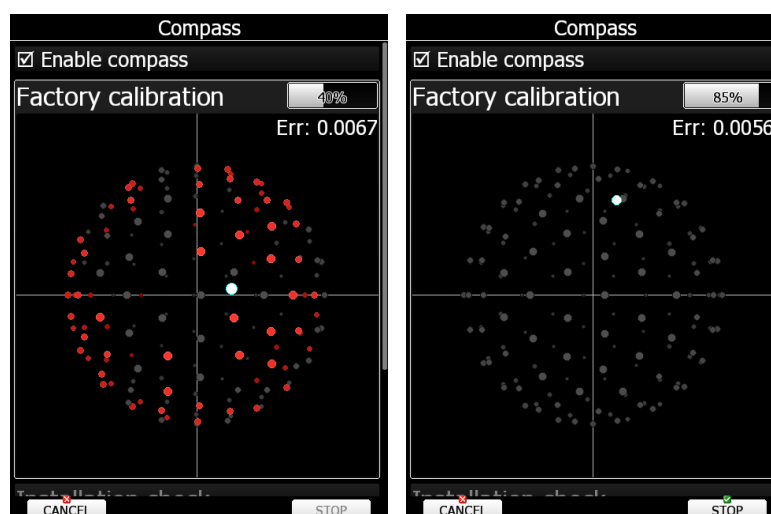

Once you have completed all the red dots, keep rotating compass to reduce the error displayed in upper right corner. When you are happy with result and you cannot reduce the error, press STOP to finish factory calibration.

It is recommended that compass calibration is saved to the SD card, once all phases are completed. Press SAVE button to save it. Press LOAD.CAL to load it from a file. When

loading from a file a confirmation dialog will be shown. Make sure that serial numbers match.

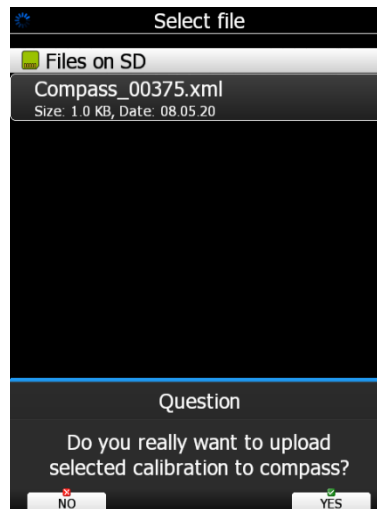

5.1.12.8 Rear Seat or Front Seat

In a two-seat configuration with the rear seat device it is possible to transfer selected data between the front and rear seat device. Use this menu to define which data will be automatically received from the other device.



Data are divided into two groups; flight parameters and navigational data. If a specific value is checked this value will be automatically received from the other device.

Check **MacCready**, **Ballast** or **Bugs** to receive current MacCready value, current ballast setting or bugs from another device.

If the **Waypoint** checkbox is checked a new waypoint target will be automatically assigned when the user changes the waypoint target on another device. The message "*Waypoint target received*" will be displayed on the screen and you will be navigating to the same waypoint as other device. Please note that it is not necessary to have this waypoint in your databases as the complete waypoint information is transferred.

If the **Waypoint** checkbox is not checked it is still possible to send a target to the other device using the SEND action in waypoint mode.

The same applies to the **Airport** checkbox. The message "*Airport target received*" is displayed.

If the **Task** checkbox is checked the task will be synchronised with the other device.



When flying an assigned area task, it is worth not having the task checkbox checked. This will allow one pilot to play with “what if” scenarios. Once a proper direction is found you can send the task to the other device using the **SEND** action in task mode.

5.1.12.9 Remote Stick*

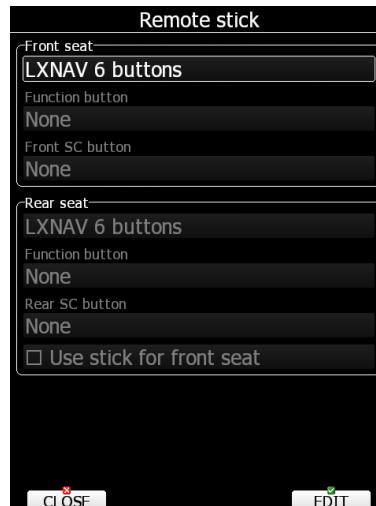

When a remote stick is connected to the system it is possible to define the type of remote stick via this menu. If a LXNAV remote stick with six buttons is connected, the user can specify the functionality of the function buttons. There are several options available for the function button:

- **SC toggle button** will toggle the Variometer between speed to fly mode and vario mode.
- **Vario priority** will temporary put the Variometer in vario mode regardless of other settings for speed to fly.
- **Toggle vario range** will toggle between vario range 2.5m/s, 5m/s or 10m/s.
- **VOLUME** will call volume menu onto the screen.
- **Toggle map settings** will toggle between two stored map settings.
- **Toggle airspace visibility** will quickly disable or enable showing of airspace.
- **Toggle thermal mode** will enter thermal mode or exit thermal mode.
- **SELECT** will call airport select menu or waypoint select menu or task edit depending on current navigational page.
- **MC/BAL** will open the Macready and ballast dialogue.
- **MAP** will open the map properties dialogue.
- **WIND** will open the wind selection dialogue.
- **AIRSPACE** will open the airspace zones dialogue.
- **MARK** will create a waypoint or marker at current position.
- **FLARM** will display a list with all FLARM objects in vicinity.
- **PAN** will set the navigational screen into pan mode.
- **EVENT** will mark a Pilot event (PEV) into the current IGC file.
- **ROT.FAI** will rotate the FAI triangle area, if shown on navigational screen.
- **TEAM** opens the dialogue to enter a team partner code.
- **Radio** will call the radio menu onto the screen.
- **Transponder** will call the transponder menu instantly on screen.
- **Screenshot** will make a screenshot.
- **WEATHER** where you can quickly select available weather layer.
- **DUMP** to quickly dump water.

- **Toggle audio source** will toggle between HAWK audio source and TE vario audio source.

On remote sticks from 2016 and onward there are two function buttons available. Also, the SC button in front of the stick is available for any of the above functions.

Check **Use stick for front seat** if there are two remote sticks installed and system does not have a rear seat device (e.g. Pipistrel Taurus, Stemme)



To activate the Function button, press FN on the remote stick and the field in the menu will become active; same procedure applies to the Front SC button.

5.1.12.10 AHRS*

Attitude and heading reference system (AHRS) consist of sensors on three axes that provide attitude information for glider, roll pitch and yaw. It helps the pilot orientate and determine the attitude of the glider (represented by yellow arrow). Ground is by default represented with brown and sky with blue colour. Line separating them is the horizon. Numbers along vertical axes show airplane pitch in degrees, numbers along horizontal line display heading and upper rounded scale displays bank (each line representing 10 degrees). Image bellow represents glider flying perfectly level.

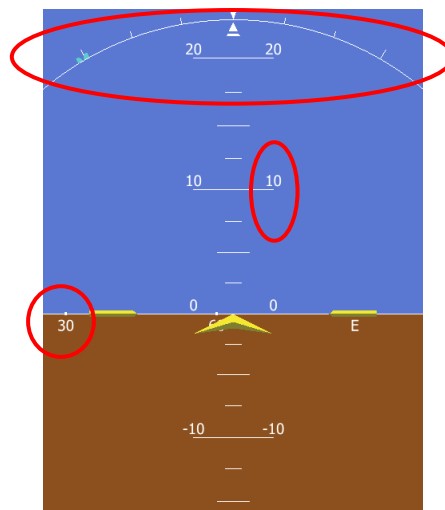

When an AHRS device is connected to the system, or the AHRS option on a V9/V8/V80 is enabled, this menu is used to calibrate AHRS for installation error.

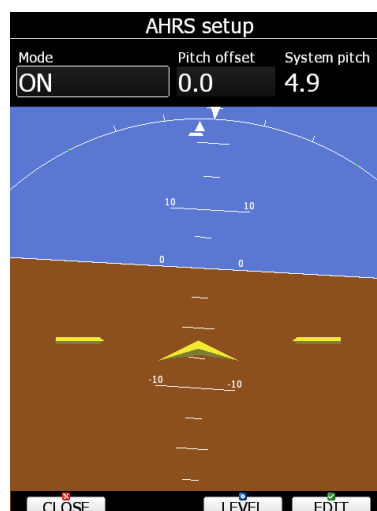

Place your glider in levelled position and press the LEVEL button. Levelling procedure will start and system pitch offset will be calculated after 20 seconds.

You can also modify pitch offset during flying, if you rotate the PAGE selector knob. A more detailed pitch set can be made using the pitch offset spin control.

Mode defines modes of operation of AHRS. AHRS can be switched to OFF mode. This will be shown in the IGC file as a BFI sentence. If the AHRS is active there will be written **BFION**.



The AHRS option is not enabled in the regular order. The option must be purchased additionally.

5.1.12.11 NMEA Output

The main display unit is capable of transmitting position data sentences in NMEA format for use by other devices.

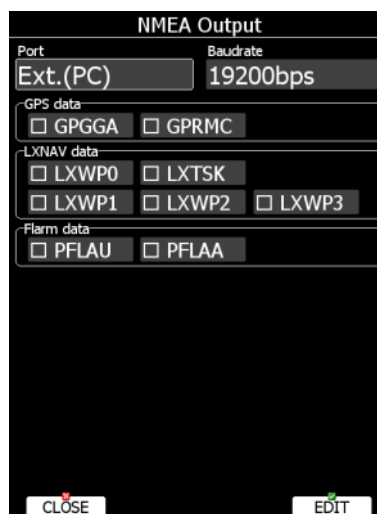

Port defines on which serial interface data will be transmitted. **Baud rate** defines transmission speed. Data is divided into three groups:

- **GPS data** will output all GPS-related data such as time, longitude and altitude.
- **LXNAV data** will output all Variometer-related data such as vario, MacCready and ballast.
- **Flarm data** will output all FLARM-related data.

You can use at once only one NMEA output port (PC or FLARM or PDA).



IF you have an external FLARM and you want to connect FLARM displays to the existing FLARM Port on the LX, you have to pay attention that on the NMEA port you have selected FLARM and that both PFLAU and PFLAA sentences are enabled.



A PDA can be connected to the LX80/90xx system through the NMEA bridge or via the EXT.(PC) port.



NMEA data is available also on the FLARM display port on the main display unit and rear display unit at 19200bps. However only FLARM data and GPS data are available.

5.1.12.12 Engine *

Use this menu when the system is installed into glider with engine. The current engine noise level is shown as a progress bar. If an external MOP sensor is installed also the MOP level will be shown.

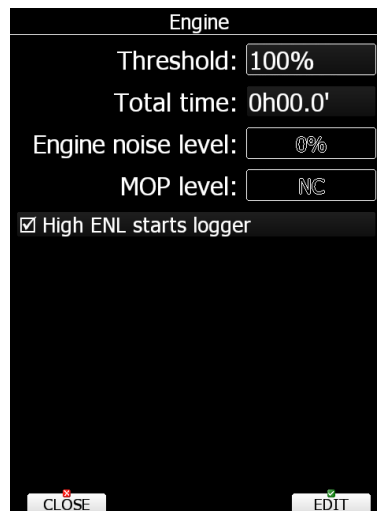

Set **Threshold** to define when engine is running. By default, the threshold is set to 100% which means no engine run will be detected. Lower this value to approximately 80% to detect a running engine. Engine noise level and MOP level below show the current value that the given sensor is detecting. If this value exceeds the set threshold value, the engine running will be detected. Easiest way to find the correct value for your glider is to check the level in this menu when the engine is turned on then set the Threshold to about 20-30% less than the measured Engine noise/MOP level. The engine total time will be accumulated and displayed in the total time box. If necessary, the total time can be adjusted to match the current engine total time. **High ENL starts logger** will start the flight recorder if this option is enabled.



The Threshold setting has no influence on the flight recorded file; it is only important for the statistics on the instrument. It sets when the engine is recognized, which resets statistics.

5.1.12.13 Network*

When the Wi-Fi option is available, this menu will setup all the parameters for network. Wi-Fi can be turned ON all the time, on ground only or off completely. Use Wi-Fi state to define the state. SMTP Settings are used to configure a server for sending email. It is recommended to leave it as LXNAV, however a user server can be configured. More options will be displayed in case of another type of server. Flights can also be stored to the SeeYou Cloud for which you have to insert the key of the cloud. Auto upload will automatically upload flights to the SeeYou Cloud.

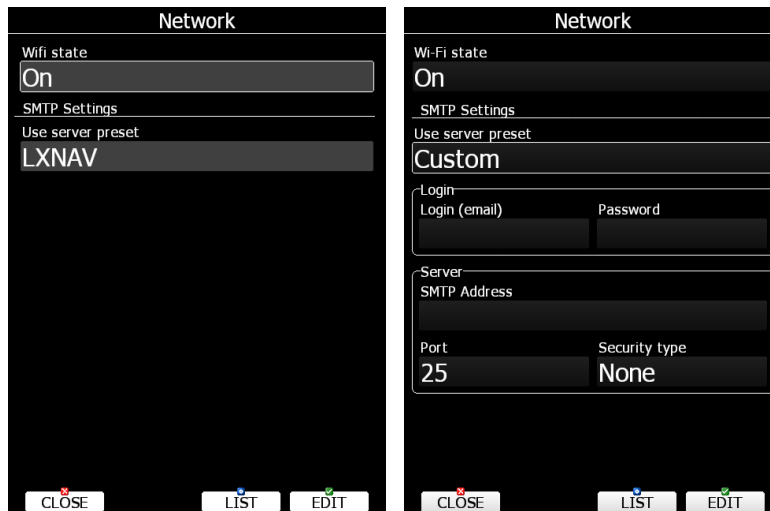

Press the **LIST** button to obtain a list of all available networks. Use the **VIEW** button to view more details about a selected network. When connected to a network the item will have blue colour.

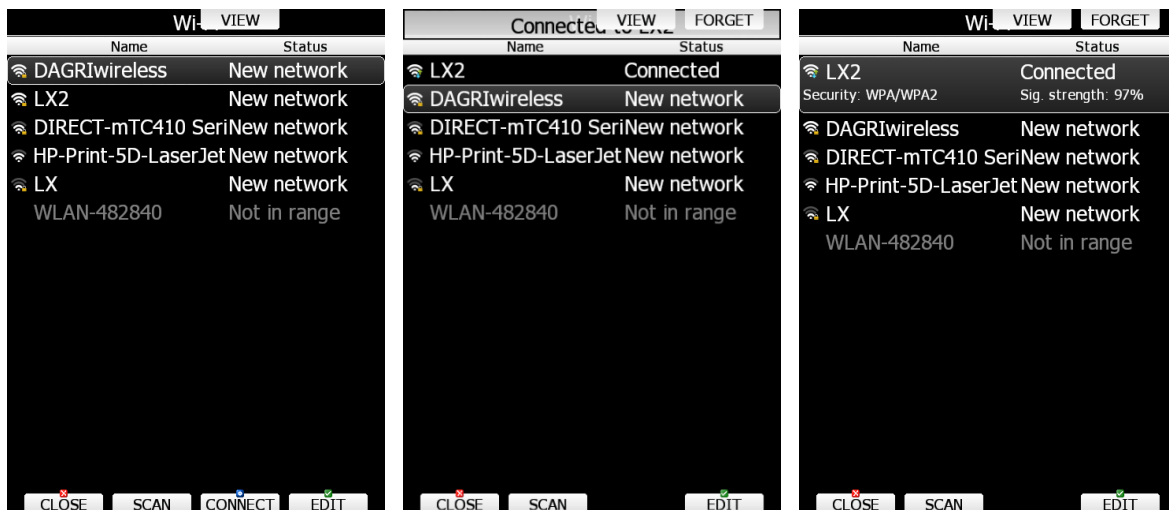

Press **SCAN** to scan for new networks. Use **EDIT** to enter a password for the selected network and to connect to it.

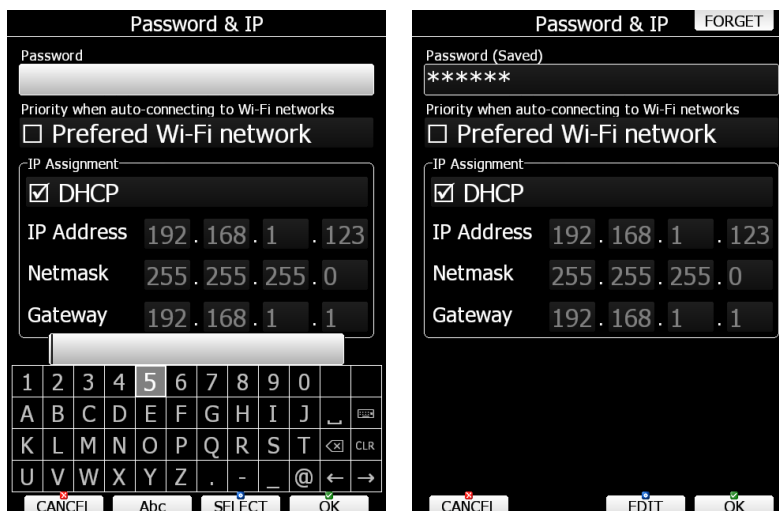

Use the preferred Wi-Fi network option if you would like to connect to this network only. Press **CONNECT** to connect to this network and press **FORGET** to forget this network.

5.1.12.14 Flaps*

When a flap sensor is installed, use this menu to set the flaps position. Use the page selector to select the desired flap position. Press the **SET** button to set the position. Repeat this procedure for all flap positions.



When all flap positions are set, a green dot will be displayed with current flap position. If flap labels are not set yet, press the EDIT button to name a flap label. Flap labels must be entered with increasing speed range. It is recommended that flaps labels are set together with speed range in the Polar and Glider setup. It is also possible to toggle between cruise and climb mode using the flap sensor. In this case there is no need to define digital input for SC.



It is very important to insert flaps in the correct order.

5.1.12.15 Battery Types*

This menu defines the type of battery being used. Selecting the type of battery is important to correctly display low battery warnings.

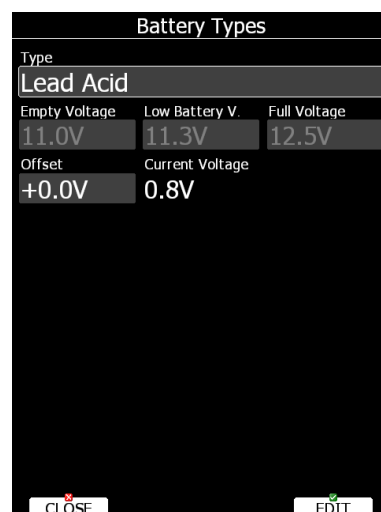

Use the **Type** combo to select the appropriate type of battery (Lead Acid, LiFe, LiPo, custom). You can see empty, low and full voltage for the selected type of battery. In case

of voltage drop due to cable lengths, you can set up the voltage **offset** there to the **current voltage** measured.

5.1.12.16 Analog Inputs

Analog inputs can be brought through with the LXdaq (data acquisition unit). LXdaq is unit connected to **RS485 bus** with 4 customizable analog inputs 0 to 5V. It can be edited under Setup>Hardware>Analog inputs.

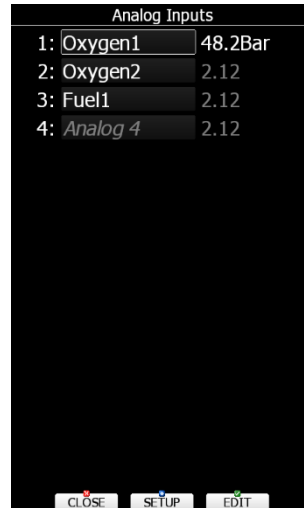

User can program each analog input by pressing **Setup**. You can change the name of the input, enter conversion table for a sensor connected to that input (which output value applies to which measured value).



An example is measuring of oxygen pressure on the bottle.



5.1.13 Polar and Glider*

With Version 8 we have significantly changed the way Polar and Glider is manipulated on the devices. Previously Polar and Glider data was stored in each profile file, now Polar and Glider data are stored on the device itself. It is possible to store up to three different Polar and Glider data on the device, which may be used for different glider configurations of wingspan.

Glider data was also extended with Weight and Balance parameters. See more about Weight and Balance setup in chapter 5.1.13.4 and 7



Weight and balance information is for informational use only. Always consult the aircraft's pilot operating handbook for the official weight and balance data.

On the first run of Version 8 when no Polar and Glider is defined in the device a migration wizard will be shown. Select first the profile with correct Glider and confirm message displayed with YES.

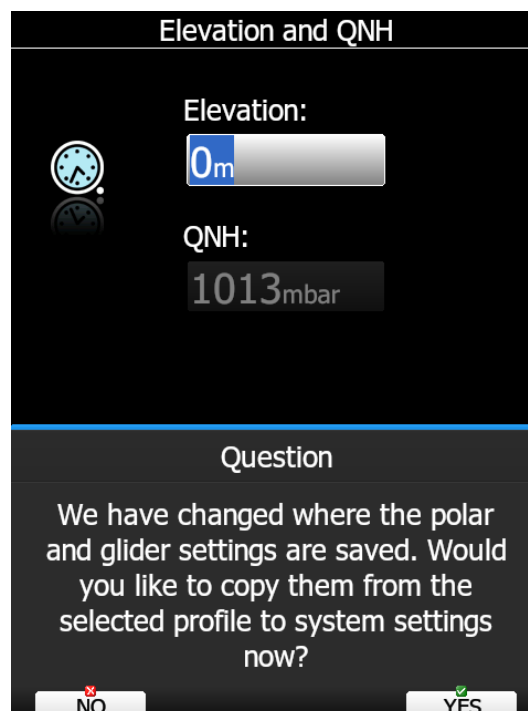

This will copy Glider from profile to device Glider and you are set up. For more detailed setup see next chapters. When you answer with NO, profile Glider will be used for calculations and you will be prompt same question next time you switch on the device.



You can add a Polar and Glider data to the system from profile also later using NEW option.

Polar and Glider data consists of four groups: glider polar parameters, weight and balance, speeds and dump rates. When opening Polar and Glider dialog, a list with defined gliders will be shown.

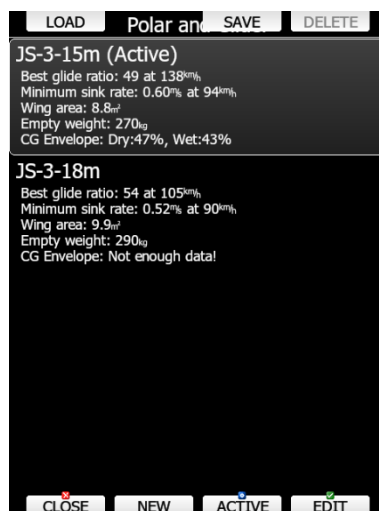

Press ACTIVE to active a glider. Press DELETE to delete a glider. An ACTIVE glider can not be deleted. Press NEW to create new glider. First a message, if you want to create a copy of selected glider will be shown, then a message, if you would like to copy polar and glider data from active profile (legacy).

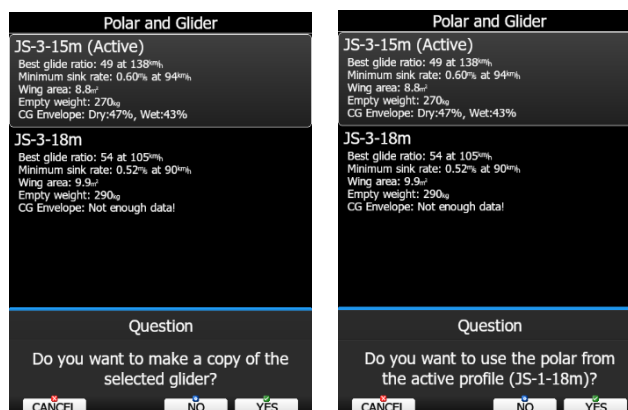

Press LOAD to load Glider data from SD Card or LXNAV Connect. Glider can be stored in file with extension .lxx, which is readable by LX Styler. Use LOAD/SAVE option to share gliders with other users.

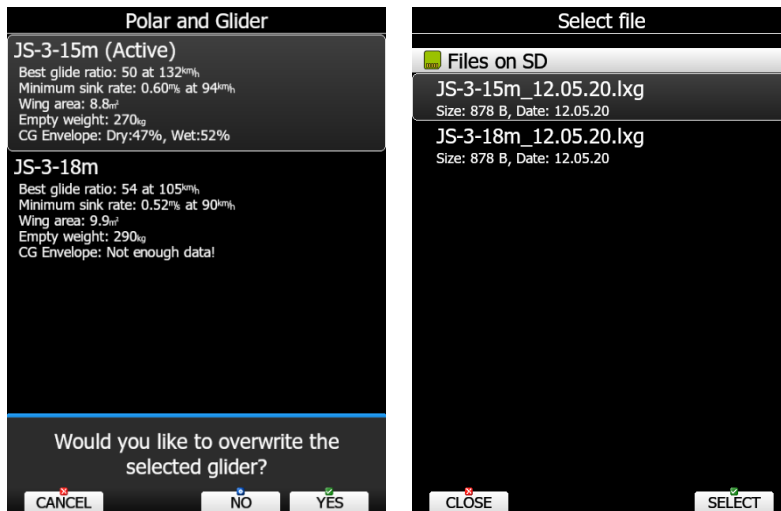

When storing glider to a file an empty glider arm is not stored intentionally. This is parameter, which is specific for each glider individually and should be obtained from latest weight and balance report.



Polar and glider are not saved on the pilot's profile. They are separate and will not be transferred to another device by just transferring .lxprofile file.

Press EDIT button to edit selected Glider.

5.1.13.1 Glider Polar

When you press EDIT button a polar dialog for selected glider will open.

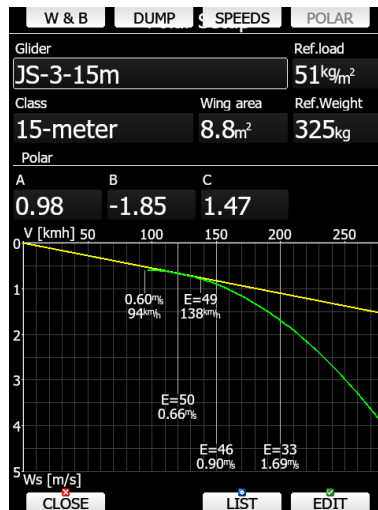

On this screen you can basic information about selected glider and graphical presentation of polar itself. You can change polar parameters or selected predefined polar parameters from the list. Polars for most modern gliders are already prepared. Press the **LIST** button and a dialogue with a list of all available gliders will be shown.

Select Glider			
Glider	E _{max}	W _{min}	Class
Antares 18S	54	0.54 ^{m/s}	18-meter
Antares 18T	51	0.49 ^{m/s}	18-meter
Antares 20E	55	0.51 ^{m/s}	Open
Antares 23T	59	0.40 ^{m/s}	Open
Antares 23E	60	0.46 ^{m/s}	Open
Apis 13m	38	0.60 ^{m/s}	Ultralight
Arcus	47	0.56 ^{m/s}	Doublese
Arcus T	47	0.56 ^{m/s}	Doublese
Arcus M	47	0.56 ^{m/s}	Doublese
ASG 29 18m	52	0.47 ^{m/s}	18-meter
ASG 29E 18m	52	0.47 ^{m/s}	18-meter
ASG 29 15m	45	0.57 ^{m/s}	15-meter
ASG 29E 15m	45	0.62 ^{m/s}	15-meter
ASW 22BLE	60	0.39 ^{m/s}	Open
ASH 25	59	0.43 ^{m/s}	Open

CANCEL
SELECT

Select the required glider using the PAGE selector knob and press the **SELECT** button. All glider data will be copied from the chosen polar.



When selecting polar from a list all glider parameters will be lost including weight and balance data and speeds.

You may quickly check the best glider ratio and minimum sink rate to see if the polar data matches the glider performance. You can modify the polar by changing coefficients **a**, **b** and **c**. A polar is defined as a quadratic equation with the parameters a, b, and c. Use the LX-Polar program to calculate coefficients a, b and c for a given glider's polar. The program requires at least three sink points entered at selected speeds (e.g.: 100 km/h, 130 km/h, and 150 km/h). The program will calculate the values of a, b and c, which should be noted and entered into the system.

You can download program free of charge from www.lxnav.com

Weights must be entered if user enters ballast in kilograms. There are three weights to enter. **Ref.weight** corresponds to the **Ref.load** value and represents the value at which the polar was measured or recalculated. Reference weight or reference wing load value will be automatically being recalculated based on the **Wing area** property.



Do not change reference weight unless you change also a, b and c parameters. Make changes in this dialog only, if you are familiar with it. Changes in this dialog will affect all gliding calculations in the device.

In top row there are four buttons used to toggle between different Glider setup pages. Press Speeds button to enter glider speeds.

5.1.13.2 Glider speeds

In this dialogue all speeds for glider and flap labels are set. Speeds should be given for a reference weight. **Stall speed** is used to generate stall warnings which are available only with the LX Voice module. For an aircraft with flaps it is also recommended to enter flap position labels and speed range for each corresponding flap position. Speed range shall be given for a reference wing loading or reference weight.

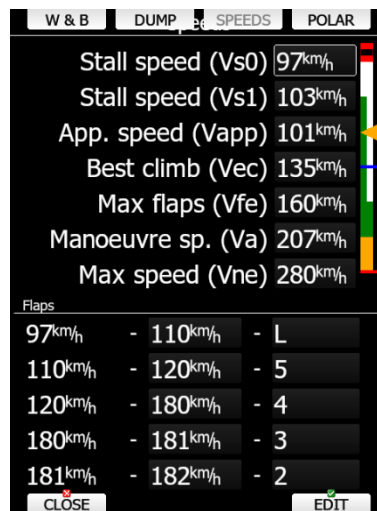

Once the speed range is entered, the system will be able to display a suggested flap position based on current wing loading and g-factor.

Press DUMP button to enter glider dump rates for water and fuel

5.1.13.3 Glider dump rates

It is possible to define various glider dump rates. These are used for calculation of the water dump rate and a fuel rate. If a dump rate is specified and water dump input is installed, the system can measure the amount of dumped water and thus automatically adjust the ballast value. Use this table to specify dump rate for a selected amount of water. At least one point must be entered. If there is only one point, it means that the dump rate is constant all the time.

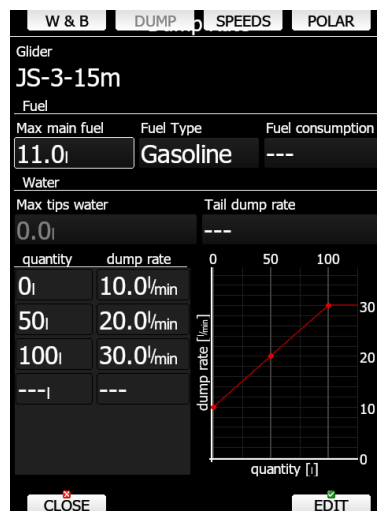

Fuel is automatically decreased, when ENL is higher than selected threshold. See chapter 5.1.12.12 how to setup ENL thresholds.



Fuel calculation is for your reference only and should not be used to estimate quantity of fuel on board. Always check your fuel quantity according to recommendation given by glider manufacturer.

Press W&B button to set parameters for weight and balance calculation.

5.1.13.4 Weight and balance setup

This dialog is used to setup parameters required for weight and balance calculation. Everything entering this dialog should be entered with great care and only, if you fully understand weight and balance.



Weight and balance information is for informational use only. Always consult the aircraft's pilot operating handbook for the official weight and balance data.



LXNAV does not take any responsibility for interpretation of data and results of weight and balance calculation. Weight and balance calculation inside the LXNAV device is not approved or certified weight and balance calculator. User should always refer to flight manual for the official weight and balance data and permitted loading of your aircraft.



Dialog consist of two parts: arms and weight defintions for parts of a glider and CG envelope defintion.

Glider arms and weights

In upper part user can define mass and arms for different parts of a glider. This data should be obtained from a glider manufacturer or should be measured. Negative arm value corresponds to value before datum point (pilot and cockpit) and positive arm value correspond to value beihnd the datum point (tail ballast). User can also input weight for selected item.

Empty glider arm and weight

Empty glider is a special entry, which must be obtained from latest weight and balance report for a given glider. Once you enter this values, a confirmation message will be shown.



It is crucial that empty glider arm and weight are entered for a given glider from latest weight and balance report otherwise calculation of weight and balance can be completely wrong and unusable for a pilot.

CG envelope

CG envelope can be entered as distance from datum point or momentum. Input method can be defined in Units setup (See chapter 5.1.11). By default, distance from datum point is selected. CG envelope consists of three areas. Permitted range defines area of allowable CG positions. Caution zone is a part of permitted area, where special attention must be paid by the pilot. Optimum zone is part of permitted area, which is suggested by glider manufacturer as optimal setting.

User should input at least four points to create CG envelope. Maximum weight for a glider with given forward and aft limits and minimum weight for a given glider with forward and aft limits for a glider.

Additionally, user can input an intermediate point for the forward limit. Caution and optional zone are also entered optionally.



In chapter 7 a sample how to enter weight and balance parameters for a glider Arcus M is explained.

5.1.14 Profiles and Pilots

All settings and navigational page layouts are stored in a profile. Profiles can be used in different ways:

- For club operation or multiple pilots sharing the same glider. Each pilot can have his personal profile.
- When a pilot is flying in several different locations. A separate profile for each location can be created (examples: France, Spain, Namibia, WGC2014).

Profile consists of two parts:

- **Navigational page layout** defines which navboxes and symbols are visible on navigational page. It defines colour of navboxes, font sizes and colours, how many navigational pages are visible and which modes are enabled. Navigation page layout can be setup with LX Styler or on device itself (See Chapter 6).
- **Device settings** includes selected databases, selected airspace and waypoints file, map colours, vario indicator settings and flight computer properties. Device settings can be modified on the device itself through the setup menu (see chapter 5.1) or with LX Styler.

An active profile is selected when the system is powered on (see Chapter 9.1.2).

5.1.14.1 Add/load profile

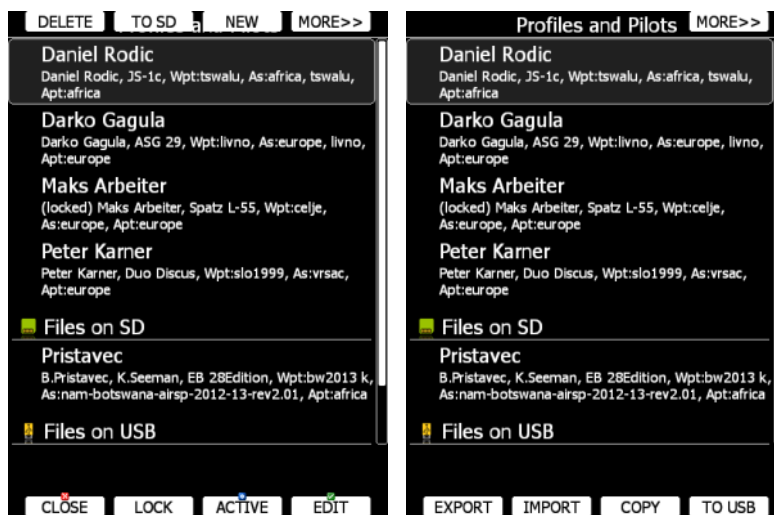

Use this dialogue to add a new profile, delete a profile, load/save a profile, copy device settings, change the name for an existing profile and to activate a profile. The active profile is the profile which is currently being used. Select a profile using the PAGE selector knob. Press **TO USB** or **TO SD** for the profile to be stored to a USB stick or SD card. Press **TO MAIL** to send the profile to email. A profile is stored as a file with the **.lxprofile** extension.

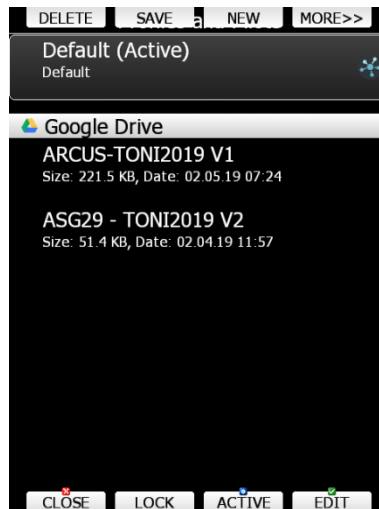

Press the **LOAD** button to load a profile from a SD card or USB stick. A profile will be copied to the main display internal storage. If you are using LXNAV Connect with Google Drive or Dropbox service, all profiles stored there will automatically appear at the bottom of the list. You can download them by clicking **LOAD**. You will be asked if you want to automatically sync this file. For details on that see chapter below. If profile with the same name already exists on your device, you will also be asked to rename the new profile. You can also save profiles on your device to your LXNAV Connect by selecting Save -> LXNAV Connect -> Google Drive/Dropbox -> Send.



LX80/90xx will detect ALL profile files (.lxprofile) stored on your Google Drive/Dropbox. Only profile files created specifically for your device type (for example LX8080) will work properly.

Press the **EDIT** button to edit the profile name, **pin protect** or **lock** it.



Pin protect your profile, if you don't want anyone to use your profile. This is recommended if your profile is registered to the LXNAV Connect service.



If you forgot the PIN, instrument will ask you, if you would like to retry or copy the profile to a new profile. Your profile will be copied, but without pilot data, saved Wi-Fi networks and without LXNAV Connect service.

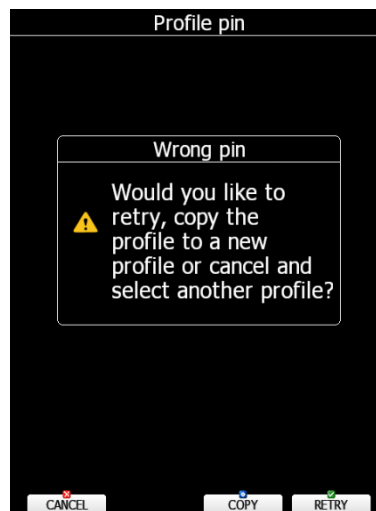

Locked profile option is very useful for club operation where one does not want a global club profile to be changed. When a profile is locked all settings will be read-only. Check **LOCK** option to lock/unlock a profile. When a profile is locked a message (locked) will be written below the profile name. Press **ACTIVE** to make the selected profile the active one.



When a profile file from a USB stick or SD card is selected, it will be available only if the SD card or USB stick is inserted in main display unit.



Selecting profiles from a SD card or USB allows you to create portable profiles, which can be transferred from one device to another.



Pilot profiles transferred from one device to another will retain all of the networks SSID and passwords used/saved on the first device.

5.1.14.2 LX Styler

A profile file can be opened and manipulated with the LXStyler program. LXStyler is a special program designed to customize layout navigational pages. It can be downloaded free of charge from our web pages www.lxnav.com. For more information about LXStyler please refer to the LXStyler manual.

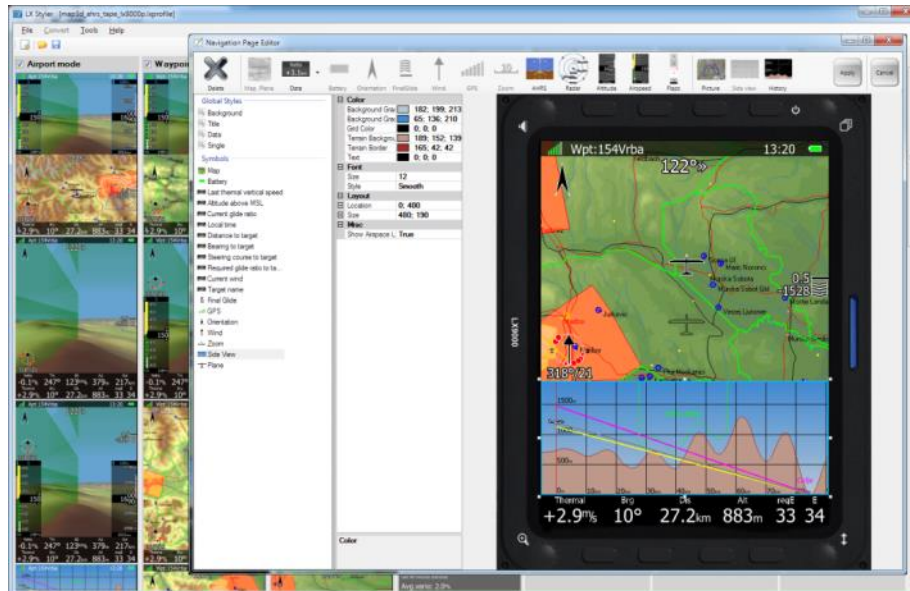

If a new profile is created with LX Styler it will have default device settings. However, it is possible to copy device settings from one profile to another profile. Select the newly created profile as the active profile. Select the profile from which you would like to copy settings to the active profile. Press the **COPY** button. A confirmation dialogue will open.

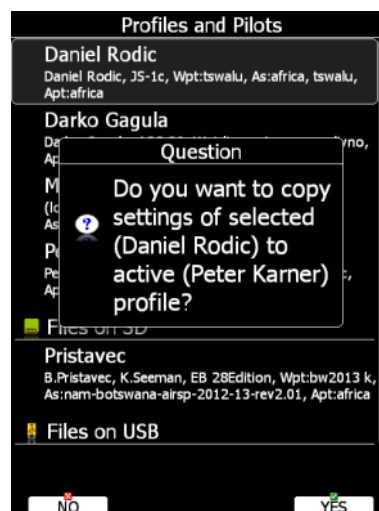

It is also possible to export a profile including all the airspace files and waypoint files. Use the **EXPORT** and **IMPORT** button to export/import a profile with airspace and waypoint data.



Export saves a file with the LXPACK extension which includes: Airspace, Waypoints and LX profile.

5.1.14.3 Sync

Profiles can be automatically synced between your instrument and Styler. To enable this option, select the profile where you wish this option is enabled and go to Save -> LXNAV

Connect -> Google Drive/SeeYou Cloud (or both) and click **SYNC**. Storage service icon will appear next to the profile. Now every time you edit this profile in LX Styler changes will automatically appear also in your LX80/90xx device. It works in both ways, so if you will change settings on your LX80/90xx device, profile will be synced with the one on your drive. For this to work LX Connect (see next chapter) must be paired, Google Drive or Dropbox service connected, and Wi-Fi connection established. If there is an error in the sync process the storage icon will have a red circle around it. For more information on how to upload/download and edit profiles in Styler please see our LX Styler manual. Sync is automatically done once a Wi-fi connection is established.

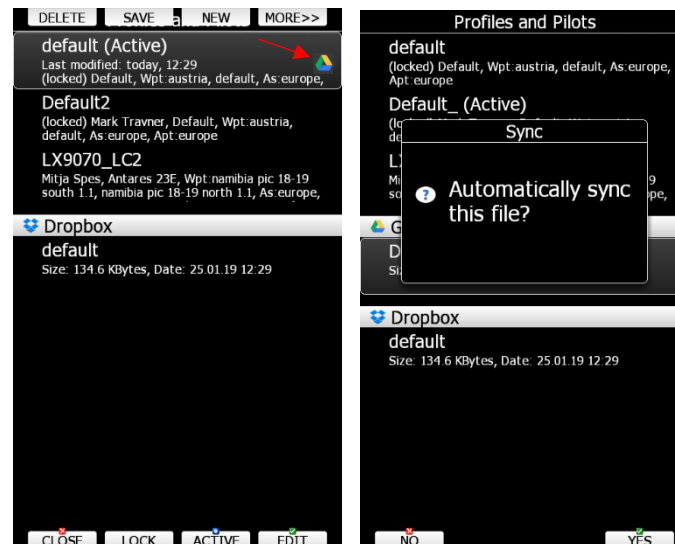

Editing profile in Styler and in the instrument at the same time can produce an error. Never try editing your profile with both Styler and in the instrument at the same time!



The profile is synced few seconds after internet connection is established. When profile is updated, you will also see a message.

5.1.15 LXNAV Connect

LXNAV Connect is a feature that allows you to overview and manage all your data and flight upload services. Once you have internet access you can check the status of each individual service.

5.1.15.1 LXNAV Connect Login

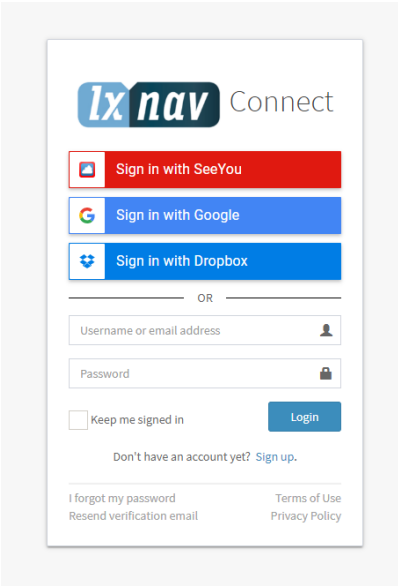

WIFI module is required for LXNAV Connect to work.

To login and connect all the different services please visit <https://connect.lxnav.com/account/sign-in> on your preferred web browser. First you have to sign up with LXNAV Cloud account, or login with Google, Dropbox, or SeeYou account. You can also recover your lost password by clicking "**I forgot my password**". Account settings can be managed in the top right corner.

5.1.15.2 Services

LXNAV Connect offers following services:

- US Sectional Charts
- Rain Radar
- GPS AeroData
- High resolution terrain packages
- SeeYou Cloud
- Google Drive
- Dropbox
- SkySight
- TopMeteo

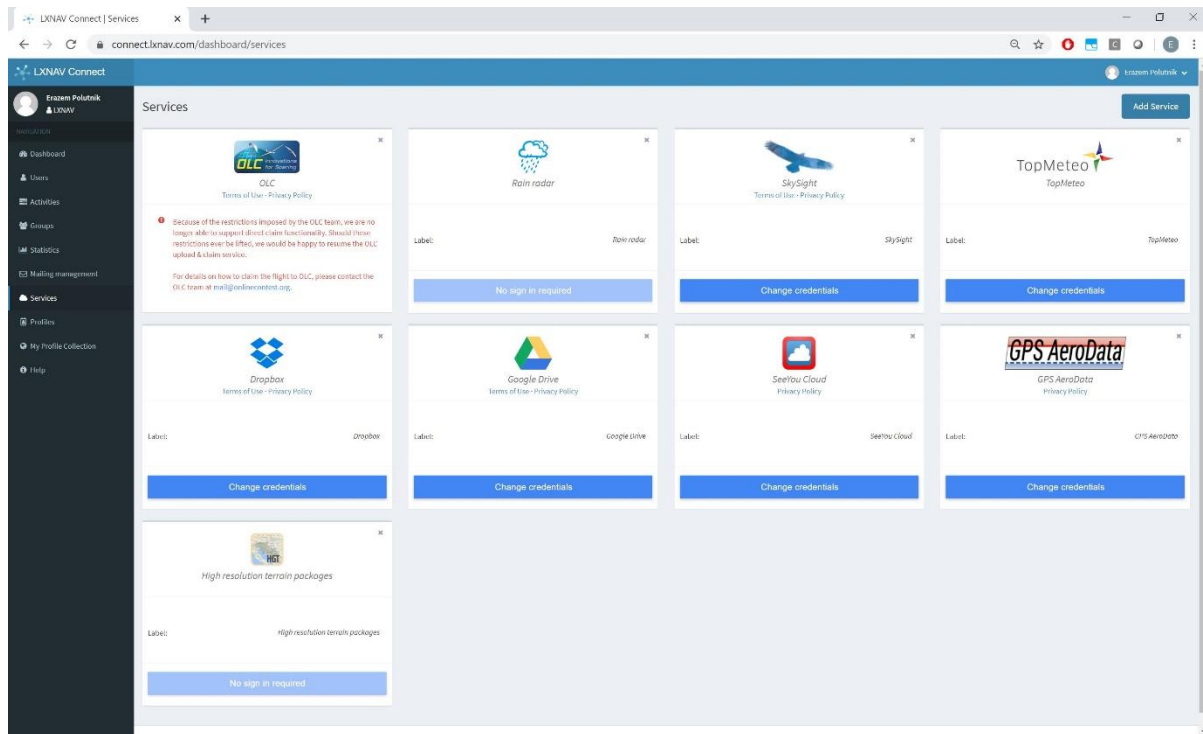

To add new service press, **Add Service**, select the desired service and login. To remove service press **X** in the top right corner of the service box.



Note that not all services are free, and some must be purchased. You can do that by visiting the website of the service you wish to obtain.

Free available services are: US Sectional Charts, Rain radar, High resolution terrain packages, SeeYou Cloud, Google Drive and Dropbox

Services, that require login account to be bought: TopMeteo, SkySight and GPS AeroData

US Sectional Charts

US Section Charts provides users with Sectional Aeronautical charts provided by FAA for the area of United States of America. Once this service is connected maps will be downloaded and be available for selection in Files and transfer>Maps menu. To see these charts on any of the navigational pages you also must enable them by going to Graphic>Map and Terrain>Show raster maps.

Rain radar

Rain radar is currently available for Europe only, free of charge.

GPS Aero data

GPS AeroData is a database that contains airspace, NOTAMs, and customized information. The database is generated and refreshed each day between 03:00 and 20:00 UTC with a 15-minute interval. It can be found at: <https://www.gps-aerodata.com/en/en-home/> - at the top bar click on **Subscribe**. Login with **email** is required.

High resolution terrain packages

High resolution terrain maps are available free of charge. You can install them by going to SETUP->Files and Transfer -> Maps.

SeeYou Cloud

SeeYou Cloud is a free of charge cloud service, which allows you to save Waypoints, Airspaces and flights. Register it at <https://connect.lxnav.com/dashboard/services>

Google Drive

Google Drive allows you to save Waypoints, Checklists, Airspaces, Profiles, flights and Flarm databases. Register it at <https://connect.lxnav.com/dashboard/services>

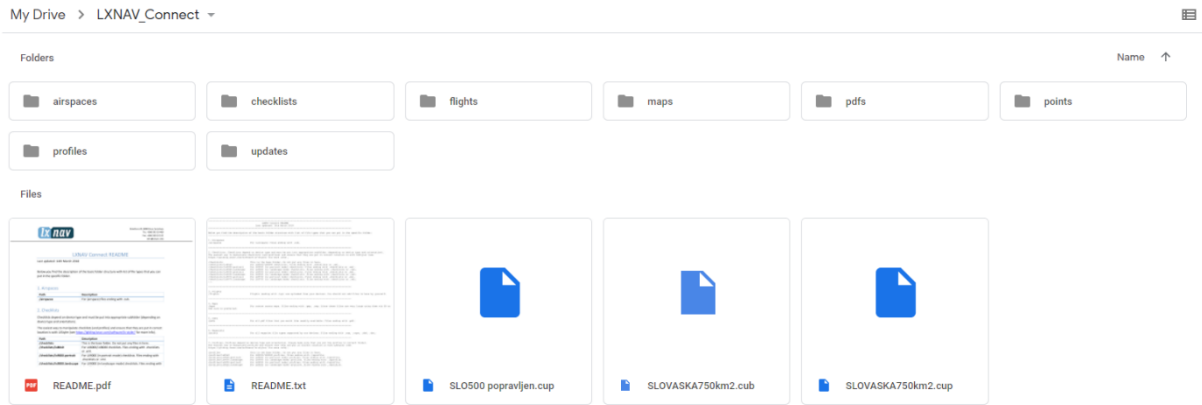

Google Drive -> LXNAV_Connect













Pilot profiles are not supported on the SeeYou cloud.

Dropbox

Dropbox allows you to save Waypoints, Checklists, Airspaces, Profiles, flights and Flarm databases. Register it at <https://connect.lxnav.com/dashboard/services>

Dropbox > Apps > LXNAV_Connect

Name +	Modified -	Members -
 airspaces	--	Only you
 checklists	--	Only you
 flights	--	Only you
 maps	--	Only you
 pdfs	--	Only you
 points	--	Only you
 profiles	--	Only you
 updates	--	Only you
 README.pdf	5 hrs ago	Only you
 README.txt	5 hrs ago	Only you

Dropbox -> Apps -> LXNAV Connect



Folder LXNAV Connect will be created in the root folder on your Google drive and in the Apps folder in Dropbox. This is the place where you can upload all your files for the instrument to access them. For details on where to upload specific files read README.pdf or README.txt file that you can find in the folder.



In order to protect your privacy LXNAV Connect can only access data located inside the LXNAV_Connect folder in your Dropbox/Google Drive!



It is possible to pair more Dropbox accounts to LXNAV Connect service.

SkySight

SkySight weather with weather layers is supported on navigation pages. Weather can be loaded during flight or even preloaded in the morning and then seen during the whole flight for the actual time available. SkySight account is required.

Following weather data is available:

- Thermal Strength & B/S Ratio
- Height of Thermals
- Depth of Thermals (AGL)
- Cu Depth
- Cu Cloud base
- Overdevelopment
- CAPE/Storms
- Rain
- Mid-level cloud cover
- High-level cloud cover
- Forecast Satellite View
- Ridge Lift
- Surface Wind (2m)
- Boundary Layer Wind (Avg)
- Convergence
- Vertical Velocity 600m/1.5km/3km/4km/5km
- XC Speed
- Freezing Level
- Turbulence



To adjust Rain radar and SkySight options, go to Graphic>Weather Layers (see also Chapter 5.1.6.9).

TopMeteo

TopMeteo weather data is supported as well. TopMeteo account is required.

Following weather data is available:

- Potential flight distance (18m)
- Cloud distribution
- Wind 3500ft (GND)
- Satellite picture



To adjust Rain radar and SkySight options, go to Graphic>Weather Layers (see also Chapter 5.1.6.9).

5.1.15.3 Profiles

Pair profile via the WEB browser.

In LXNAV Connect webpage on your computer go to **Profiles** and click **Pair profile** and type in the code described above. To remove profile simply press **X** in the top right corner of the profile.

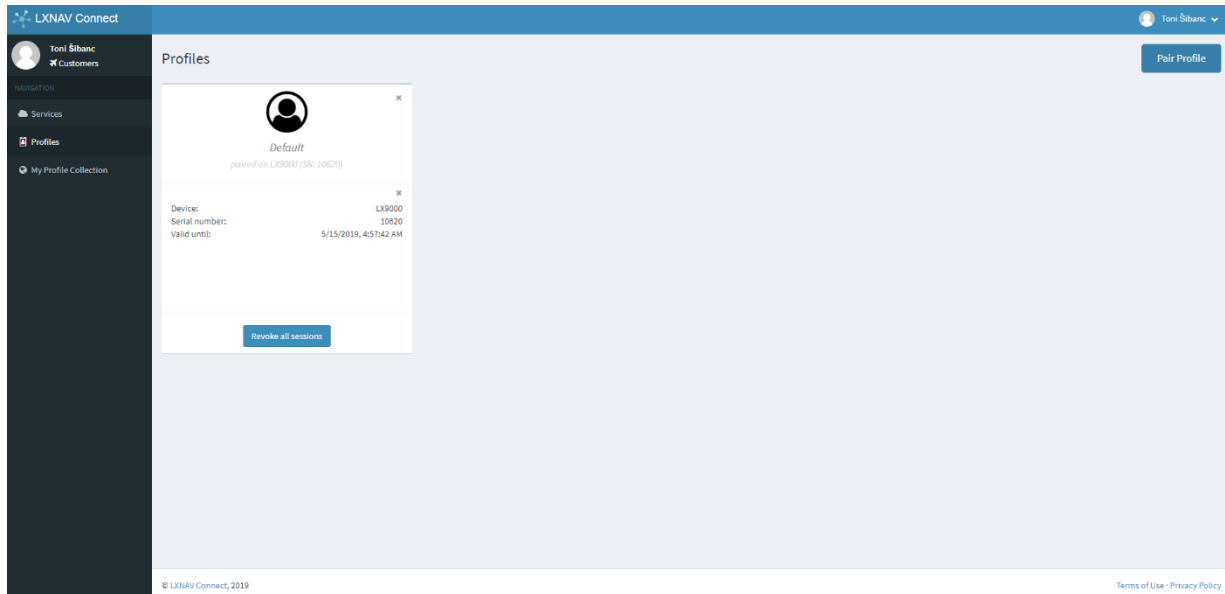

Pair profile on the device.

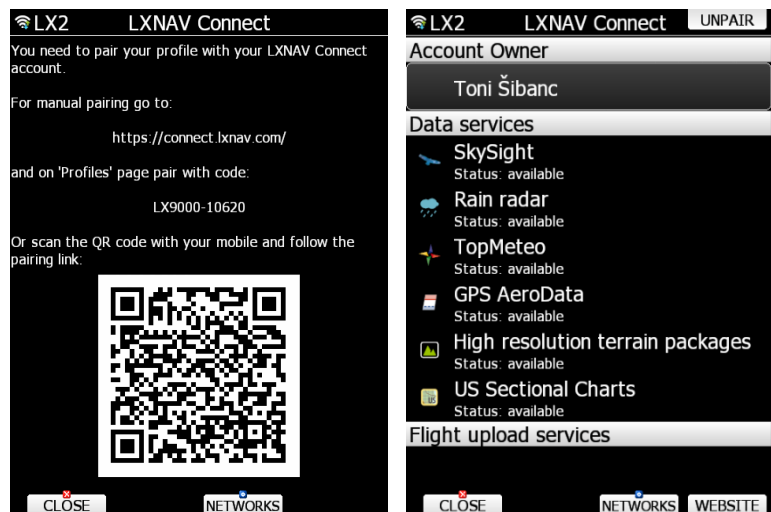

You can pair multiple profiles to the same LXNAV Cloud account. On your LX80/90xx device go to LXNAV Connect page. If profile is not yet paired there will be a welcome page with instructions on how to pair, link to the website and QR code that you can scan with your smartphone. There is also a code in the format of LXyyyy-xxxxx (yyyy – device model for example LX8080, xxxxx – serial number). Paired profile will have an LXNAV Connect icon displayed next to it.





Each profile of your instrument can only be paired with one LXNAV Connect account.



If you try to change the name of the profile (pilot name), profile will automatically unpair to prevent unwanted pilot accessing your profile. If you modified your profile intentionally simply pair it back again as you did before.



Please note that any user on of your LX80/90xx can access your profile if it is saved on the device and will be able to access your services even the ones you are paying for, if they are added to your profile as described below. You can avoid this by having your profile only on SD card that you remove after flying.

My Profile Collection

Pilot Profiles can be uploaded via LX Styler to LXNAV Profile Collection
<https://gliding.lxnav.com/lxdownloads/profile-collection/>

Published profile can only be deleted here by clicking on the "X" button.

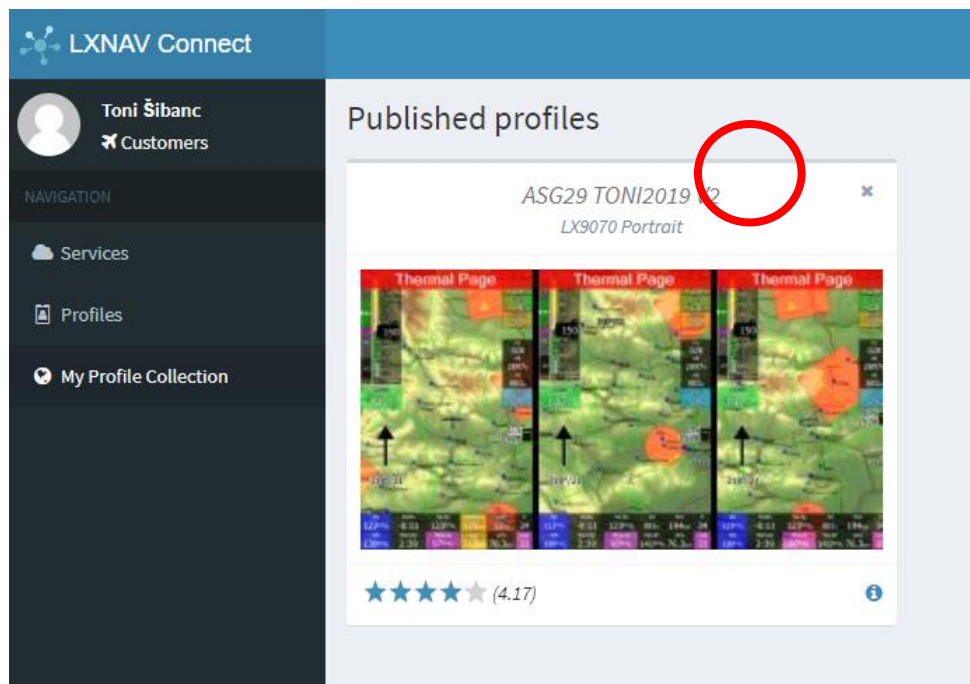

5.1.15.4 LXNAV Connect limitations

LX8000 Generation 1 doesn't support a Wi-fi module, therefore LXNAV Connect isn't available.

LX8000 and LX9000 Generation 2 supports a Wi-fi module, but there are some limitations. Following services are not available:

- SkySight
- TopMeteo
- High resolution terrain packages
- Google Drive
- Satellite pictures

Services are greyed out on the instrument.

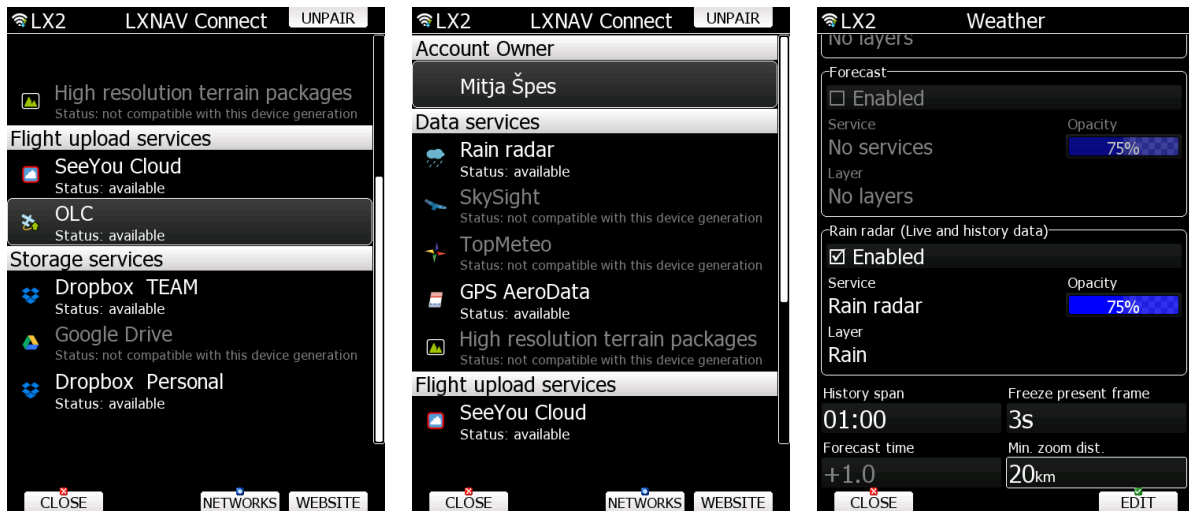

Based on your internet connection speed it might take some time to load functions or data. Blue icon will appear in the upper left corner of the screen whenever your device is still in the process of downloading or uploading data.



5.1.15.5 LXNAV Connect SERVICES button

If you click SERVICES button, you can switch between three pages: **services**, **website** and **cache**. Initial page is always list of the **SERVICES**. On the **WEBSITE** page is a link to the website and QR code linking to the website. On the **CACHE** page you can see the download progress of the weather layers.

5.1.16 Language

The system can run in different languages.



Select the desired language. The main display unit will reload and restart in the new language. If your language is not listed and you feel able to become a translator for the system, please do not hesitate to contact us.

Currently available languages are: Czech, German, English, Spanish, French, Italian, Dutch, Polish, Slovenian, Finnish and Russian.

5.1.17 Passwords

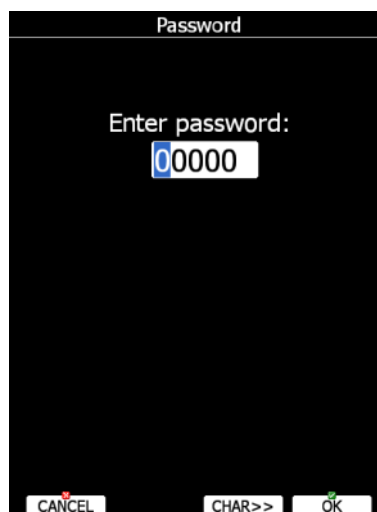

- **89891** is used to initiate the firmware update procedure.
- **89892** is used to update peripheral devices
- **99999** will erase all flights stored on the main display unit.
- **55556** will enable Condor simulator input via the PC port.
- **00111** display information about the system and its sensors.
- **00112** will perform integrity check of stored maps and terrain data
- **00113** will perform system temperature test
- **00666** will make factory reset
- **01043** will perform "Auto zero", set indicated speed to zero.
- **01044** enable or disable automatic auto zero of speed sensor at end of flight.
- **01045** will perform "Auto zero", align gyros.

- **01046** Reset gyro offsets.
- **01049** will perform "Auto zero" and set indicated speed to zero for OLD LCD varios.
- **19019** Flarm Carp reset
- **30000** browse through installed files (use with caution).
- **31000** browse SD card
- **32000** browse USBE drive
- **33333** reset recorded min/max temperature.
- **33400** shows menu with all passwords
- **41000** first or forced update of FLARM.
- **42000** update of FLARM through PC port (default).
- **42001** Flarm reset
- **43001** toggle 485bus logger.
- **43002** toggle V8x logging for HAWK data
- **44440** enter continuous grab mode.
- **44441** shows debug information.
- **44442** displays kernel log
- **49147** Toggle switch of the Flarm between internal/external

5.1.18 Admin Mode

Admin mode is very powerful tool to disable functionality of the system for normal users. It is designed for club usage where one person is taking care of all instruments.

To enable Administration mode, check the **Enable admin mode** box. The next step is to enter and re-enter the administration password. Once the password is entered it is possible to define which actions a normal user can perform. **Use single layout** will use Graphical LAYOUT (navboxes etc) settings only from the selected active profile. If you will change/activate any other profile, settings – layout will remain from the active one.

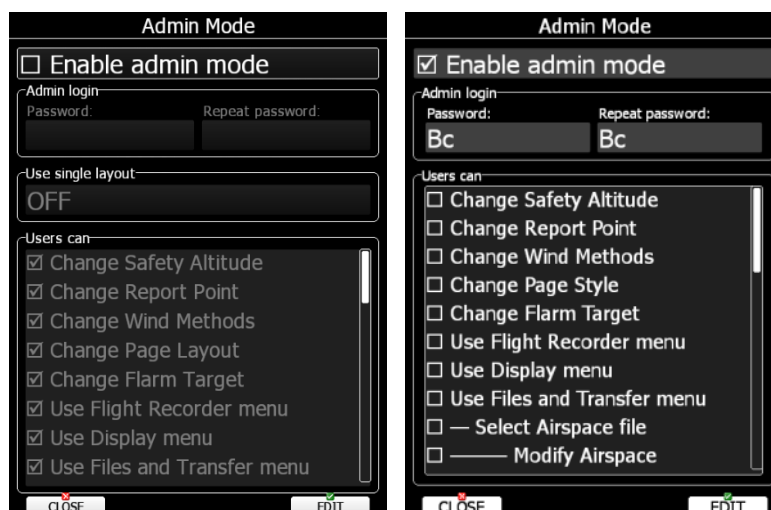

There are several actions, which can be disabled for normal user:

- **Change Safety Altitude**, user will not be able to set the safety altitude.
- **Change Report Point**, user will not be able to set report point, if it is already set.
- **Change Wind Methods**, user will not be able to change methods for wind calculation.
- **Change Page Style**, it is not possible to change page layout.
- **Change Flarm Target**, user cannot change FLARM targets names and other data for it.
- **Use Flight Recorder menu**, user cannot modify flight recorder properties.
- **Use Display menu**, user cannot modify display properties.
- **Use Files and Transfer menu**, it is not possible to use the entire files and transfer menu.

- **Select Airspace file**, user cannot select and modify airspaces at all.
- **Modify Airspace**, user can select different airspace file, but he cannot edit or delete it.
- **Select Airport file**, user cannot select and modify airports.
- **Select Waypoints file**, user cannot select and modify waypoint files.
- **Modify Waypoints**, user can select, but cannot delete, waypoint file.
- **Select Raster maps**, user cannot select and modify scanned maps.
- **Modify Raster maps**, user can select, but not modify scanned maps.
- **Format SD Card**, user cannot format SD card.
- **Update Databases**, user cannot update databases.
- **Modify PDFs**, user cannot delete stored PDF documents.
- **Delete Flight**, user cannot delete stored flight.
- **Use Graphics menu**, cannot use this menu.
- **Use Sounds menu**, cannot use this menu.
- **Use Observation Zones menu**, cannot use this menu.
- **Use Optimization menu**, cannot use this menu.
- **Use Warnings menu**, cannot use this menu.
- **Use Units menu**, cannot use this menu.
- **Use Hardware menu**, cannot use this menu completely.
- **Use rear/front seat menu**, user cannot use this menu.
- **Use NMEA output menu**, user cannot use this menu.
- **Use Polar menu**, user cannot modify any glider parameters
- **Use Profiles menu**, user cannot modify Profiles at all. He can change the profile only by restarting the device.
- **Modify Profiles**, user cannot delete, edit or lock a profile.
- **Use Language menu**, user cannot use this menu.
- **Use Passwords menu**, user cannot use this menu.

Once actions are selected and admin mode is closed, user will observe un-selected items greyed-out.

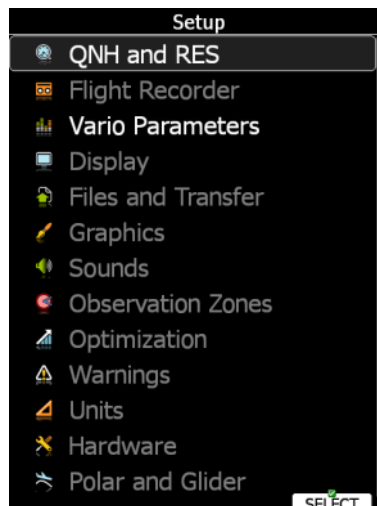

5.1.19 About

About dialogue show serial number, software version, installed terrain, software options and update status (if the Wi-Fi module is installed). Use this menu whenever you are experienced a problem with the system. The UPDATE button will give an option to update the system to the latest version.

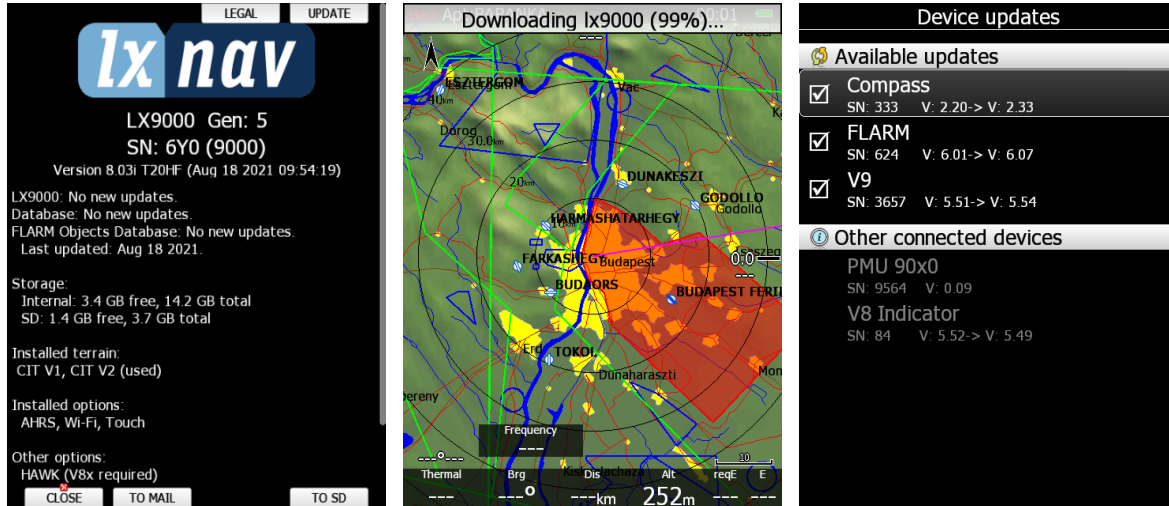

You can see also all options installed and available for this type of device. If particular option is not compatible, it will be written.

5.1.19.1 Debug report

If a SD card is inserted into the main display unit the TO SD button will be shown. Press TO SD and a debug report will be saved to the SD card. A report will have a name like »debug_20140216_14_21_28.report«. Please email this report to us for further help. If a network connection is available you can also use the function TO MAIL, which will send the Debug report to email, or even more, you will be asked if you would like to send this report to LXNAV support directly.

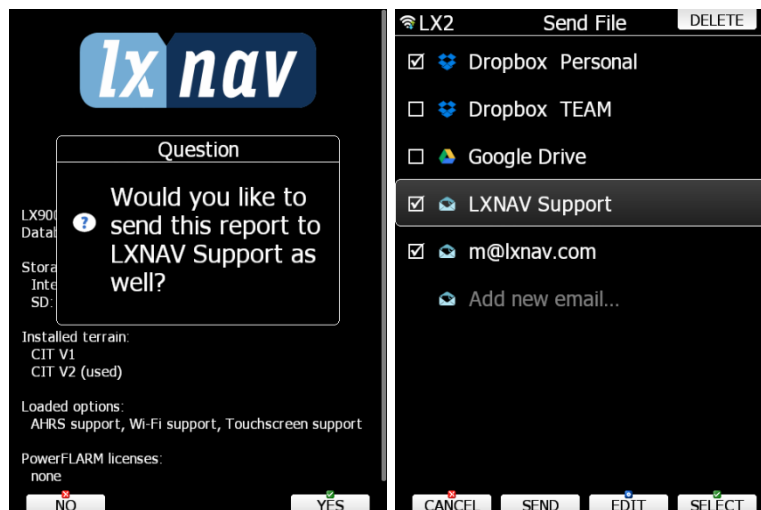

5.2 Information Mode

Information mode comprises four pages; GPS status page, position report page, satellite sky view page and network status page. Use the PAGE selector knob or the up/down arrow to toggle pages.

5.2.1 GPS Status Page

GPS status, altitude, flight level and height are shown on this page. Sunrise and sunset are calculated for the current position. In the upper-right corner the current FLARM status is shown. TX means FLARM is transmitting data to others and the number indicates how many other FLARM devices are within range.

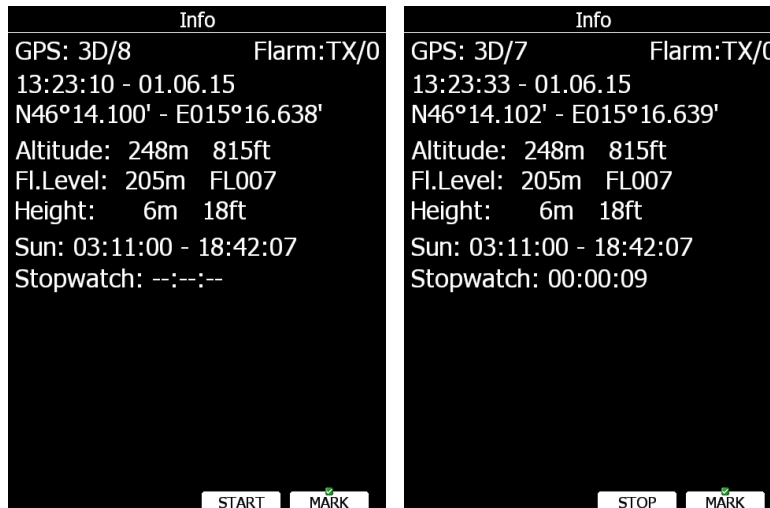

Press the **START** button to start the stopwatch. Press the **STOP** button to stop the stopwatch. If you press the **MARK** button a new waypoint will be created with the current latitude, longitude and elevation based on the terrain database. The waypoint name is generated from the current date and time separated by the minus character and is preceded by an underscore.



Waypoint data can be modified. Refer to Chapter 5.6.1 for more details. Press the **OK** button to save a marked waypoint or press **CANCEL** to exit without saving. Press the **GOTO** button to navigate immediately to the selected point.

5.2.2 Position Report

This page shows your position report relative to an arbitrary selectable point. Use this page when you are talking to ATC.



Press the **REPORT** button to select a report point. Radials will always be magnetic, and distance will always be in nautical miles. If you press the **MARK** button a new waypoint will be created.



Radial in position report page is based on magnetic compass reading and NOT true compass reading.

5.2.3 Satellite Sky View

Information about tracked satellites is given on this page. If no satellite information is available a message "No satellite info" is displayed.

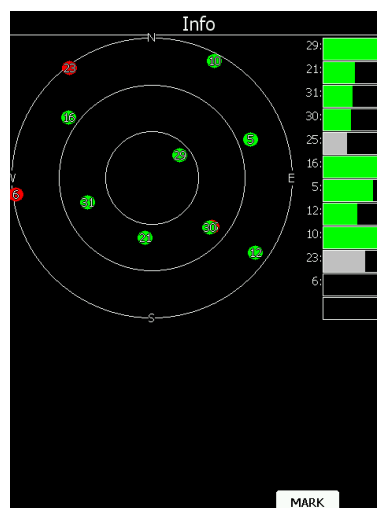

Green satellites are satellites currently being used for position determination. Three concentric circles represent satellite elevation (0, 30, 60 degrees above horizon). If a satellite is in the centre of the circles it is directly overhead.

When you are experiencing bad satellite reception, check this page. If the satellites are always red in a particular place, you should consider moving the GPS antenna to another position. If you press the **MARK** button a new waypoint will be created.



With some instruments that page is not visible

5.2.4 Network Status

Network status information is given on this page. Press the **LIST** button to list available networks. Press the **SETTINGS** button to set up network properties. See also Chapter 5.1.12.13.

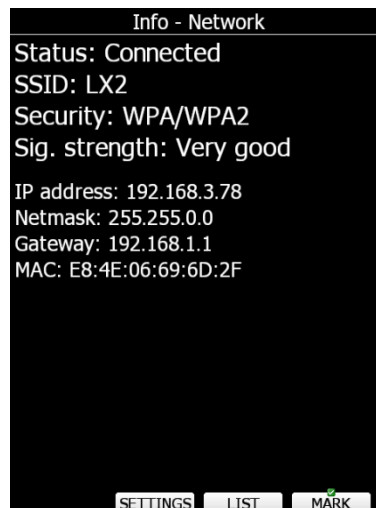

5.3 Near Mode

A list of all landable waypoints and airports is shown in this mode. The default sorting order of the items is by arrival altitude. Press the **SORT** button to toggle the sort method. The selected sort method is indicated by the grey background in the header.

Near			
Name	Dis.	Brg	Arr
BUDAORS	9.49km	229°	-354m
DUNAKESZI	13.4km	22°	-455m
HARMASHATARHE	9.52km	302°	-526m
BUDAPEST FERIH	15.4km	118°	-534m
FARKASHEGY	13.1km	262°	-536m
TOKOL	19.3km	202°	-583m
GODOLLO	19.7km	63°	-711m
ESZTERGOM	38.7km	317°	-1093m
KECSKED	56.9km	271°	-1634m
KECSKEMET	82.7km	141°	-2245m
MATKOPUSZTA	88.8km	149°	-2400m
JAKABSZALLAS	93.1km	154°	-2512m
SZOLNOK	97.1km	115°	-2595m
GYOR-PER	96.4km	278°	-2614m
SZENTKIRALYSZA	96.6km	240°	-2771m
SIOFOK KILTI-SA	104km	226°	-2814m

Near			
Name	Dis.	Brg	Arr
Mayerhofen	62.7km	8°	-424m
AJDOVSCINA	64.9km	205°	75m
SLOVENJ GRADEC	67.4km	84°	-494m
SENTVID	70.6km	137°	-374m
POSTOJNA	74.0km	182°	-608m
GORIZIA	76.2km	221°	-133m
CELJE	78.0km	104°	-530m
Rwy: 11/29-G-900-/0m Freq: 128.800 Elev: 244m			
Description: Tel. +386 3 5472030			
xMurau	77.9km	358°	-934m
xLendorf	78.5km	306°	-692m
xJenig	79.5km	286°	-907m
xMadlig	79.9km	334°	-1173m
DIVACA KRASKI	U83.7km	192°	-745m
xSchoeder	85.8km	353°	-1218m
TRIESTE RONCHI	88.8km	222°	-398m

Press the **VIEW** button to change how much detail is visible for a selected item.

In the **VIEW** mode you can define how columns order and which columns you would like to see.

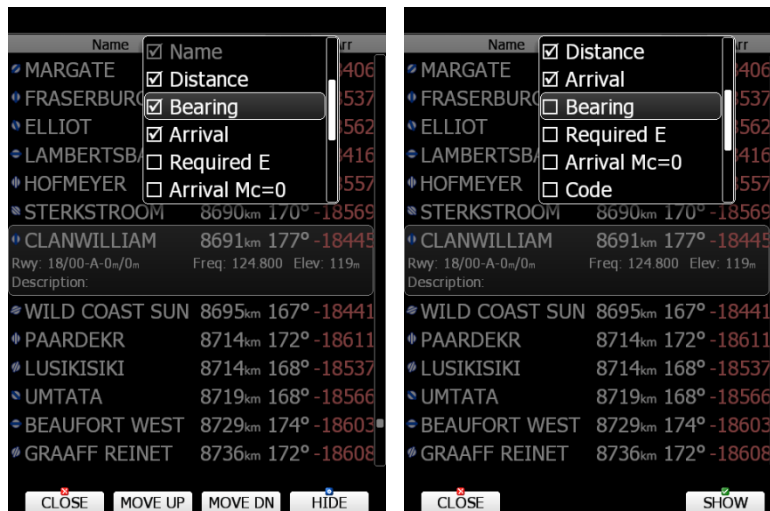

Select the preferred landable place via the PAGE selector knob and press the **GOTO** button. It will automatically change to airport mode and navigation will commence to the selected point.

Duplicates are automatically removed. If a target with nearly the same latitude and longitude is found within both the distributed airports database and user waypoint file, then only the target from the user waypoint file will be displayed. Press the **FREQ** button to set the standby frequency if this option is available (if a radio bridge is present).

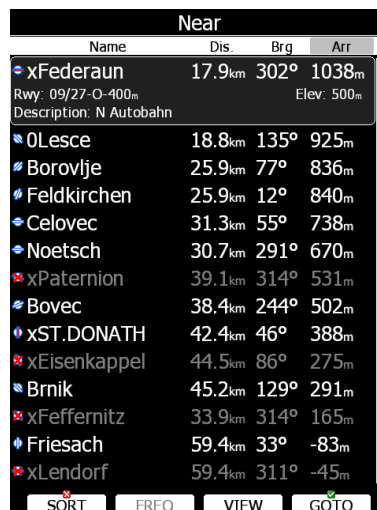

Press the **REPORT** button to quickly access the report page described in the chapter 5.2.2. This is useful when you need to quickly report your position while also attempting to find the suitable landing spot.



A small rectangle in bottom right corner of point icons indicates that there are images available for the selected point. A red cross is drawn over an icon, when the length or width of the landing point is smaller than that defined in Setup. See also Chapter 5.1.7.4

5.4 Statistics Mode

The Statistics mode operates in two different ways. During flight statistical data for the current flight is shown whilst on the ground the logbook for all stored flights is displayed.

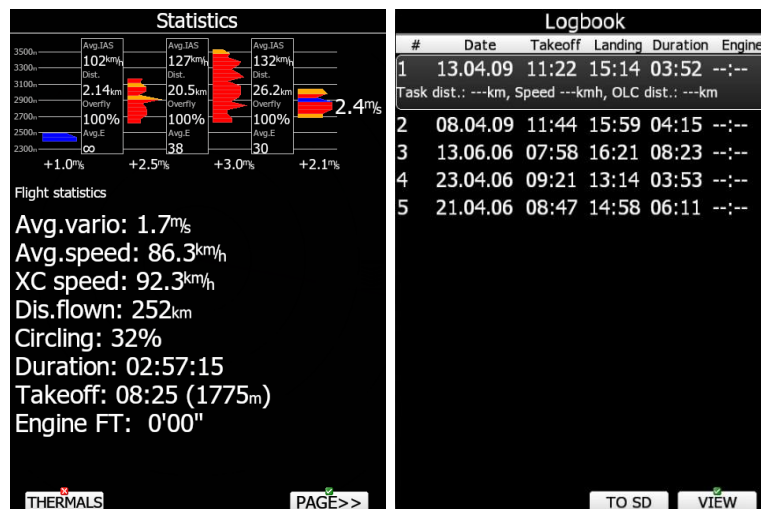

5.4.1 Logbook

If a SD card or USB stick is inserted into the main display unit, the user can copy a selected flight to it. Select the desired flight using the PAGE selector knob and then press the appropriate button. Press the **SAVE** button to save a flight to SD or LXNAV Connect. If user is having LXNAV Connect account, there is an LXNAV Connect option (if system has a Wi-Fi module).



LX8030 and LX8040 devices require add-on SD card reader to transfer flights via your SD card. You can still use USB stick or transfer flights via integrated Wi-Fi module.

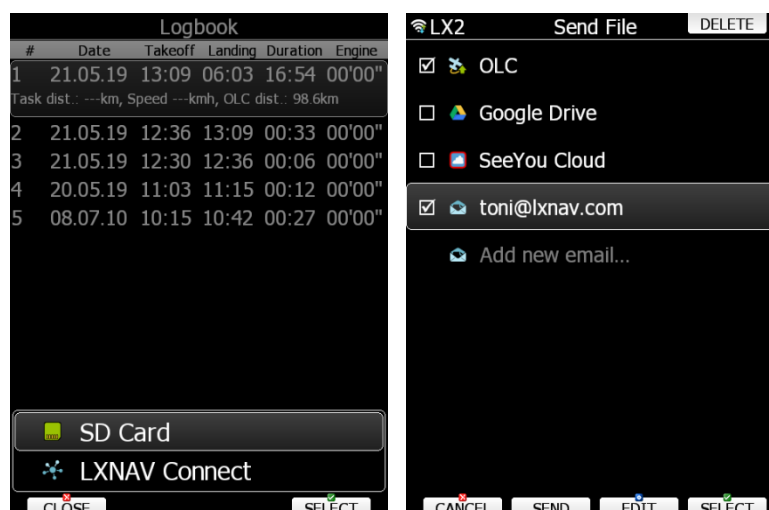

A flight is automatically copied to the SD card and/or USB stick if it has been inserted into the main display unit by the time the message "Calculating security" is displayed. This message appears when landing conditions are met.

You can also delete a flight using the **Files and Transfer** menu (see Chapter 5.1.6.7). Press the **VIEW** button to replay the flight. The flight viewer will open.

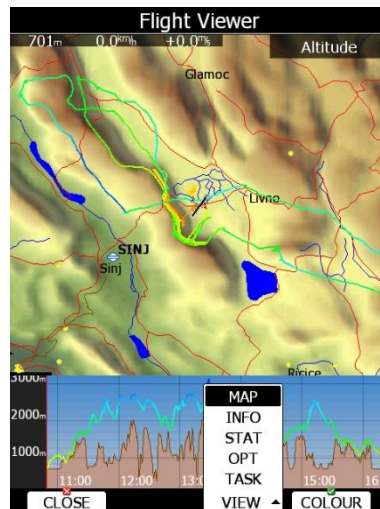

A map with the flown path is shown together with a barogram. Use the **ZOOM** selector knob to zoom in or zoom out. Use the **PAGE** selector knob to move through the flight. Press the **VIEW** button again to toggle between map view (date, take off, duration, soaring started), statistics (average speed/vario/altitude, maximum speed, minimum/maximum vario), optimizations (legs and distance) and task (distance, speed, task duration). On the map view you can also press **colour** to change flown path colours from altitude, ground speed to netto.

5.4.2 Statistics during flight

The main statistics page is split into two parts. In the top part the last four thermals are shown. Thermal average is shown below each thermal column. Thermals are coloured based on the MacCready value. Red colour means that thermal average was 0.5 m/s or more above current MacCready setting. Blue colour means that thermal average was 0.5 m/s or less below current MacCready setting. Orange colour indicates matching thermal average.

On the left side an altitude scale is drawn. On right side the average of last four thermals is displayed.

The shape of the thermal column corresponds to the strength of the thermal at a particular altitude.

You can see data for leg between two thermals in the columns between set two thermals. Data displayed are: Average indicated airspeed, Average efficiency, Distance and overfly factor. Overfly [%] is the ratio between integrated flown distance and the shortest (straight) distance between two thermals.

Overfly factor will be in most cases above 100%, however in very rare conditions when thermals are drifted with wind, it can be also below 100%.

Press the **THERMALS** button to disable or enable thermal's view.

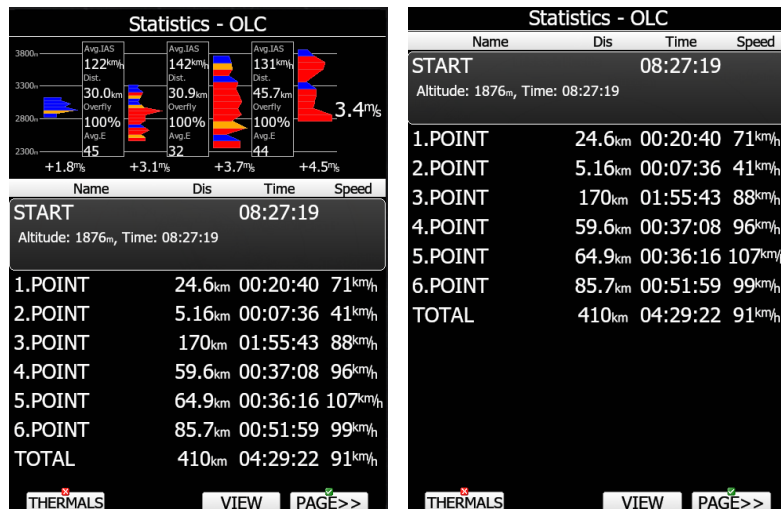

In bottom part selected statistics is shown. There are three different pages of statistics available:

- **General statistics**, which is divided further into flight statistics, task statistics and last 60 minutes statistics.
- **Detailed task statistics** displays detailed statistics for each task set.
- **OLC statistic** shows statistics for optimized part of the flight according to the rules defined in the Optimization menu.

Use the **PAGE>>** button to toggle between different pages.

5.4.2.1 General Statistics

Using the PAGE selector knob the user can change the statistics subpage.

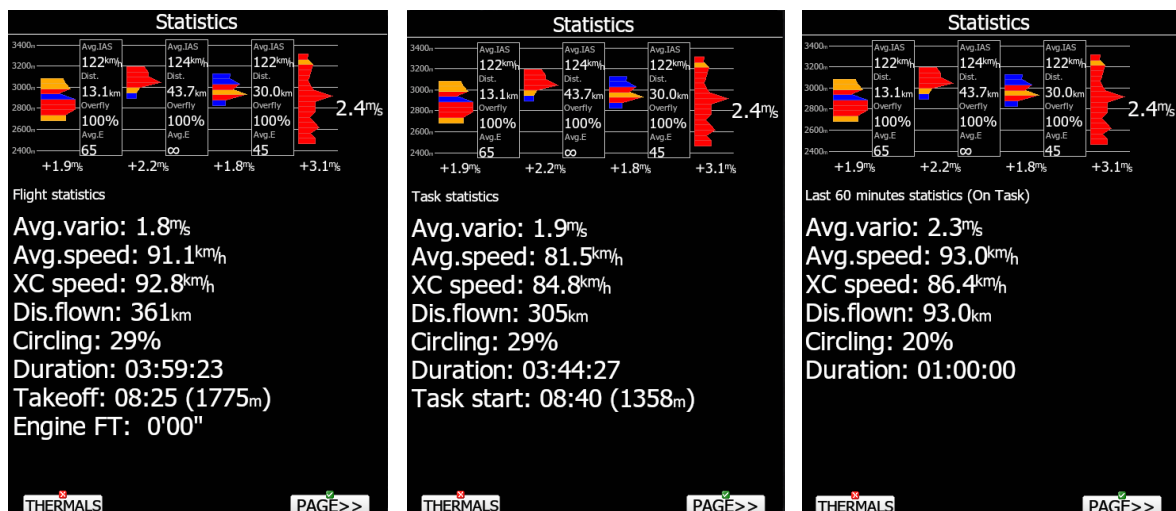

There are three subpages available:

- **Flight statistics** displays data for whole flight. **Dis.flown** is the optimised distance. XC speed is average speed corrected for altitude difference throughout the whole free flight (not task). **Average vario** is used in this calculation.
- **Task statistics** displays data for the started task. Distance flown is the distance that has already been flown on the task.
- The **last 60 minutes** statistics displays data for the last 60 minutes of flight. If the task was started then **Dis.flown** is the distance flown on the task for the last hour otherwise it is the optimised distance. If the task distance is used a remark (On Task) is displayed in the header.

5.4.2.2 Detailed Task Statistics

Using the PAGE selector knob the user can select different task points. Press the **VIEW** button to show more details for a selected leg.

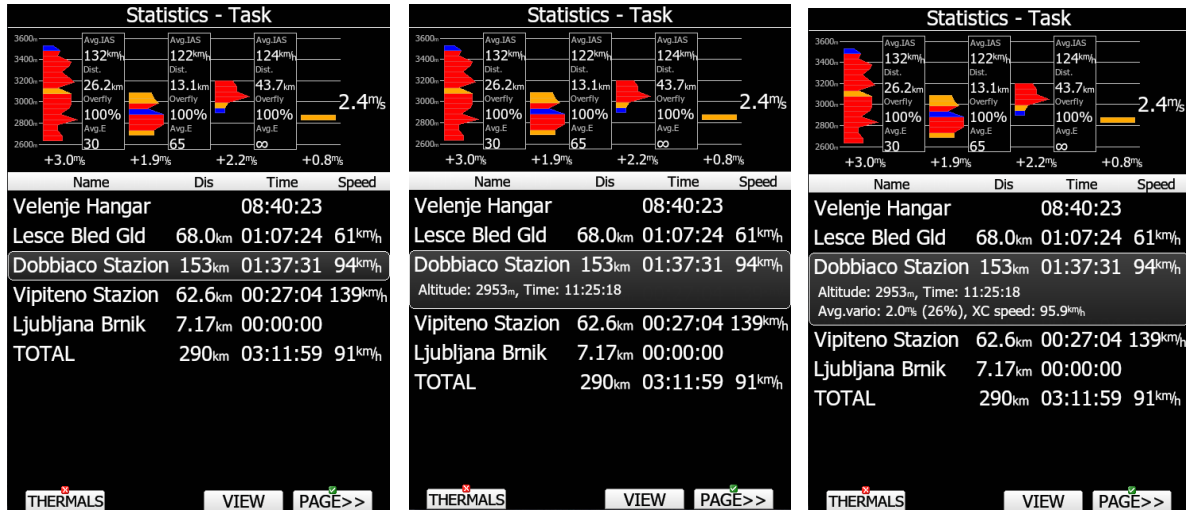

5.4.2.3 OLC Statistics

Using the PAGE selector knob the user can select different optimized points. Press the **VIEW** button to show more details for a selected optimized leg.

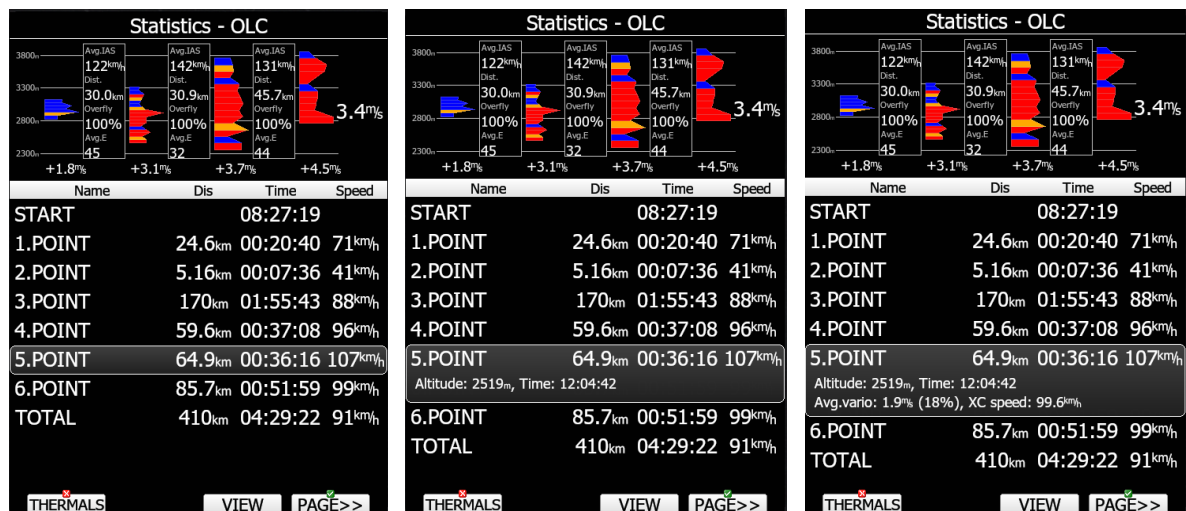

5.5 Airport Mode

Using the PAGE selector knob, you can scroll through the pages. There are several navigational pages available.



Navigational pages can be customised using LXStyler. The description below applies to the default navigational pages.

5.5.1 Initial Navigation Page

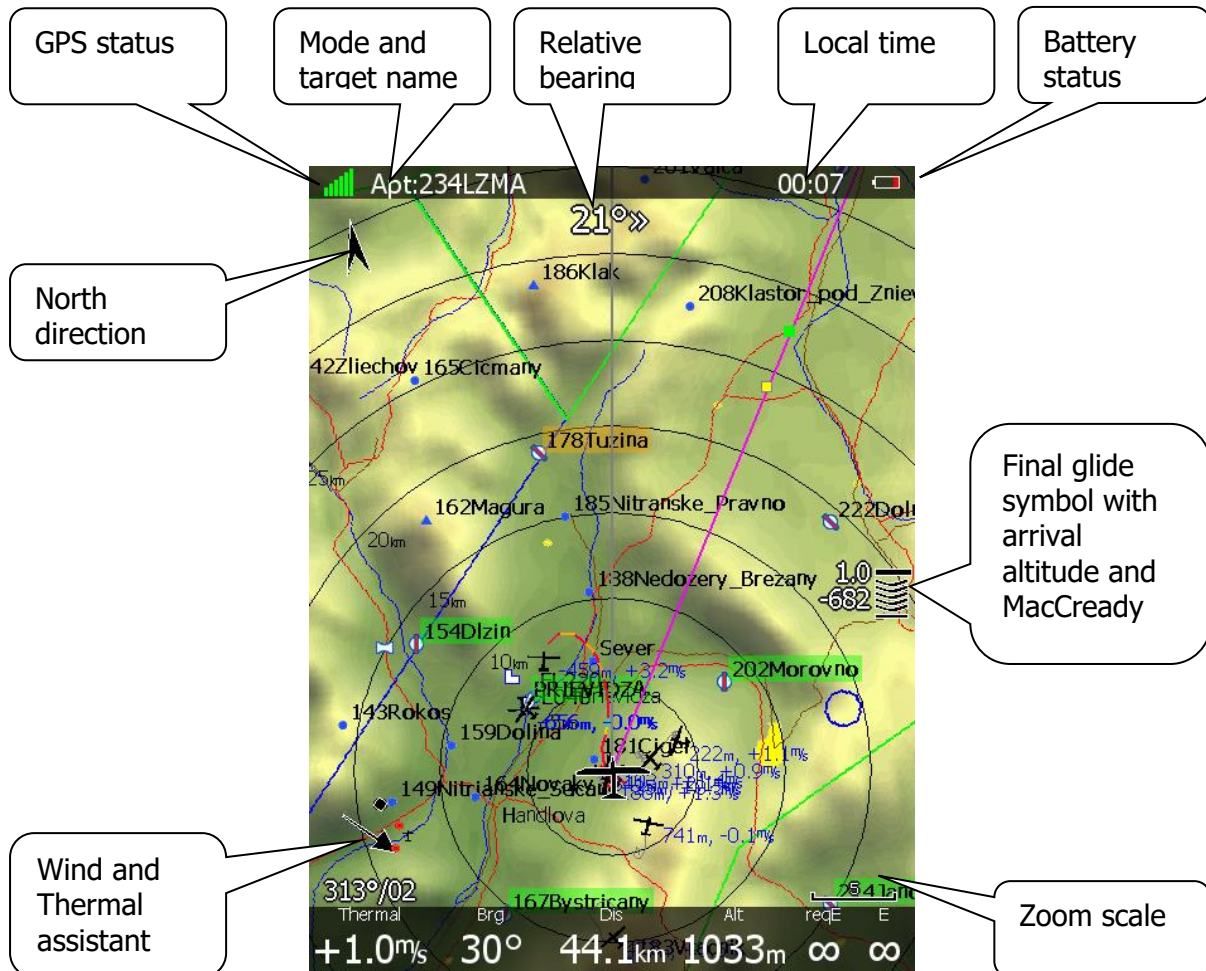

In the top row the GPS status is shown. Green colour represents GPS 3D, yellow colour means GPS 2D and red colour is GPS bad. The number of coloured bars indicates the number of visible satellites. Each bar represents two satellites.

Local time shows the local time. You can set a different time zone in the **Units** dialogue (see Chapter 5.1.10.5).

The battery symbol indicates the status of the battery. When the battery is very low the symbol will turn red and also the **Low battery** warning will be displayed.

North direction is pointing to true north. This is important if the map orientation is not north up at the top.

The airplane symbol in the middle of the screen is showing the current position. The grey line indicates our current ground track and the magenta line is connecting the airplane position to the selected goal. When we are below the glide-path to the current goal a green and a yellow rectangle will be displayed on the magenta line. The green rectangle

represents the position from where you will achieve the final glide with current altitude and current MacCready setting. The yellow rectangle represents the position from where you will achieve the final glide with current altitude and MacCready zero.

The relative bearing (near the top) gives advice on which direction and how much to turn in order to fly towards the selected target. In the above example we should turn right 21°.

In the lower-left corner of the screen a **wind symbol with Thermal assistant** is displayed. The thermal assistant continuously analyses the thermal whilst circling. The sizes of the dots indicate the strength of the thermal. The arrow indicates the wind direction relative to the map orientation. Wind direction and wind speed are presented numerically below the arrow.

The final glide symbol is a complex symbol. The bottom number shows your predicted arrival altitude. Negative numbers indicate that you are below the glide path and positive numbers indicates you are above the glide path. The middle number is the current MacCready setting.

Zoom scale is displayed in the bottom-right corner of the screen. A distance corresponding to the zoom symbol is plotted above the scale. If there is a letter "a" next to the distance scale it means that the scale of map will automatically adapt to the goal.

In the bottom row several items are displayed. **Thermal** shows the last thermal average, **Brg** is the bearing to the selected target, **Dis** is the distance to the target and **Alt** is the current MSL altitude.

The last two numbers (**reqE** and **E**) show the required glide ratio to the target. In the above example the required glide ratio is infinitive and current glide ratio is also infinitive. The current glide ratio is calculated over the last three minutes of flight.

5.5.2 Second Navigation Page

The second page is similar to the first page with additional data shown in the bottom line.



The additional items are the current net vertical speed, current track, ground speed, height above ground and optimised distance.

5.5.3 Third Navigation Page

The third page is a combination of first navigational page and side view.

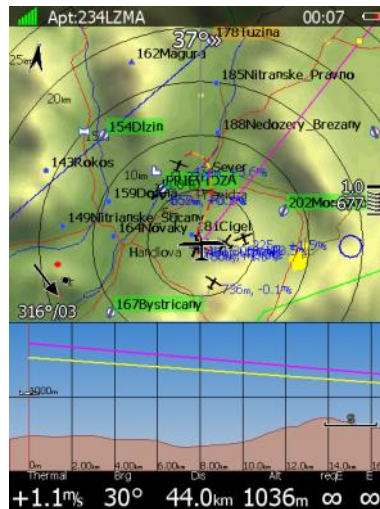

The side view is showing the lateral view from the glider towards the selected goal. Terrain below the glider is displayed including glider projected track in grey colour based on the glide ratio. Yellow and magenta lines are showing the requested glide ratio to goal based on zero MacCready setting and current MacCready settings.

5.5.4 Fourth Navigation Page

The fourth navigational page is combination of FLARM radar screen and some additional altitude data.

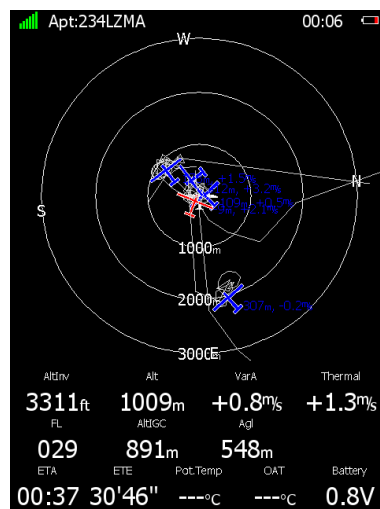

The internal pressure sensor altitude is shown as **AltIGC**. **AltInv** shows the altitude in opposite units to those defined in the **Units** setup. **OAT** is the outside temperature. **Potential Temperature** is temperature calculated to the mean sea level and can be helpful with identifying if there is enough heat to trigger thermals and how strong they might be. **Battery** displays the current voltage. The estimated time of arrival and estimated time established are displayed at the bottom part of page.

5.5.5 Fifth Navigation Page

On this page images of the selected airport are shown, if available.



Also, information for the selected airport is shown at the bottom part. This information includes airport frequency, runway info and description. The estimated time of arrival, estimated time established and sunrise/sunset times for the selected target are displayed in last row.

5.5.6 Button actions Related Only to the APT Page

5.5.6.1 Select an Airport

There are five different methods of selecting an airport. They are called **filter** mode, **ICAO** mode, **list** mode, **map** mode and **history** mode. You can toggle between these five modes by pressing the **select** button, then press the **METHOD** button several times to select the preferred mode.



Filter mode

Selecting an airport in filter mode is straightforward. Enter the first letter of the airport name using the PAGE selector knob. The helper will show the first airport matching this letter and the next few airports will be displayed in lower part of screen.



Press the **CHAR>>** button and the cursor will move to the second letter. Use the PAGE selector knob to select the second letter. If you wish to return to the first letter turn the ZOOM selector knob counter-clockwise.

You will note that part of the airport name is written in a darker colour. Once it becomes white it means this is the only selection. Pressing **GOTO** will navigate directly to it. If there are more than one airports starting with the filtered letters and you press the **GOTO** button the cursor will jump to the beginning of the airport name. The PAGE selector knob will select among the airports. Press **GOTO** once more and you will navigate to it.



If you do not know the exact name of an airport just select the first letter and press the **GOTO** button. Now scroll to the desired airport using the PAGE selector knob. Press the **GOTO** button once more and you will navigate to the selected airport.

By default, the main display unit will search airports through all countries. It is possible to create a search only from selected countries. Press the **COUNTRY** button and a dialogue with a list of all available countries will be shown.

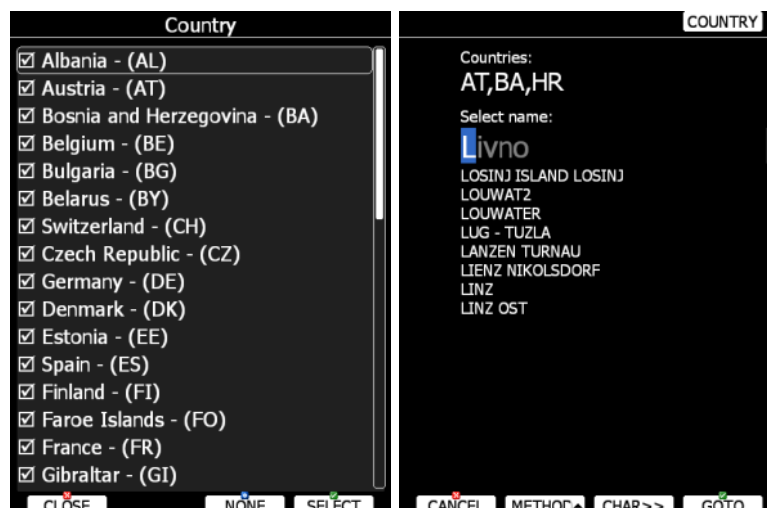

Select the desired countries and press **CLOSE**.

ICAO mode

In this mode airports are selected by ICAO identifier rather than by name. Operation is exactly the same as in filter mode.



List mode

In list mode airports are listed as in near mode.

VIEW	COUNTRY
Name	Dis. Brg Arr
▶ Livno	6.05km 48° -115m
▶ VISOKO	106km 73° -3567m
▶ SARAJEVO	119km 85° -4114m
▶ CILJUGE	165km 62° -5533m
▶ TUZLA	169km 61° -5693m
▶ LUG - TUZLA	176km 62° -5963m
▶ POPOVI	225km 59° -7643m
▶ OSIJEK CEPIN	244km 34° -8287m
▶ OSIJEK KLISA	245km 38° -8353m
▶ BEOGRAD	300km 65° -10418m
▶ SZEGED	377km 41° -13226m
▶ VRSAC	387km 64° -13630m
▶ JAKABSZALLAS	397km 32° -13960m
▶ MATKOPUSZTA	405km 32° -14278m
▶ SZENTES	416km 39° -14667m

VIEW	COUNTRY
Name	Dis. Brg Arr
▶ Livno	5.77km 51° -151m
Rwy: 13/31-G-810-/30m Freq: 123.500 MElev: 716m	
▶ SINJ	15.5km 244° -50m
▶ SPLIT KASTELA	51.0km 241° -999m
▶ BRAC BRAC ISLAN	54.5km 194° -1660m
▶ HVAR	66.6km 195° -1557m
▶ PLOCE	92.9km 149° -2550m
▶ MOSTAR	96.4km 123° -2789m
▶ VISOKO	106km 73° -3630m
▶ SARAJEVO	119km 86° -4181m
▶ UDBINA	123km 316° -4347m
▶ ZALUZANI-BANJA	125km 13° -3968m
▶ ZADAR ZEMUNIK	127km 288° -3743m
▶ BANJA LUKA	136km 15° -4371m
▶ URIJE - PRIJEDOL	137km 356° -4403m

VIEW	COUNTRY
Name	Dis. Brg Arr
▶ Livno	5.64km 49° -172m
Rwy: 13/31-G-810-/30m Freq: 123.500 MElev: 716m Description: MON ? SUN 09.00 ? 14.00 Winter time MON	
▶ SINJ	15.6km 245° -82m
▶ SPLIT KASTELA	51.1km 241° -1029m
▶ BRAC BRAC ISLAN	54.5km 195° -1685m
▶ HVAR	66.6km 195° -1582m
▶ PLOCE	92.7km 149° -2571m
▶ MOSTAR	96.1km 123° -2809m
▶ VISOKO	106km 73° -3651m
▶ SARAJEVO	119km 86° -4201m
▶ UDBINA	123km 316° -4378m
▶ ZALUZANI-BANJA	125km 13° -3995m
▶ ZADAR ZEMUNIK	127km 288° -3774m
▶ BANJA LUKA	136km 14° -4398m

Press the **VIEW** button to change details of the selected airport. In the **VIEW** mode you can define how columns order and which columns you would like to see.

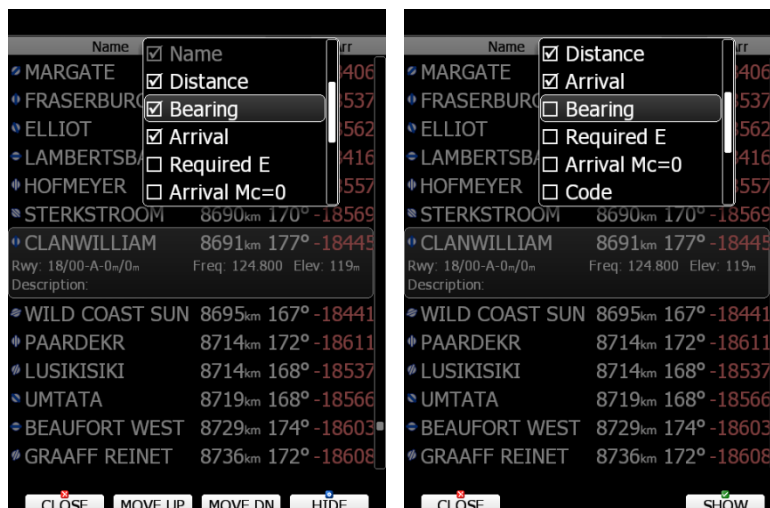

Press the **SORT** button to change the sort order of the airports. Select an airport using the PAGE selector knob. Press **GOTO** and you will navigate to it. Press the **COUNTRY** button and a dialogue window with a list of all available countries will pop up.

Map mode

In map mode, airports are selected directly on the map. Rotate the PAGE selector knob to select an airport.

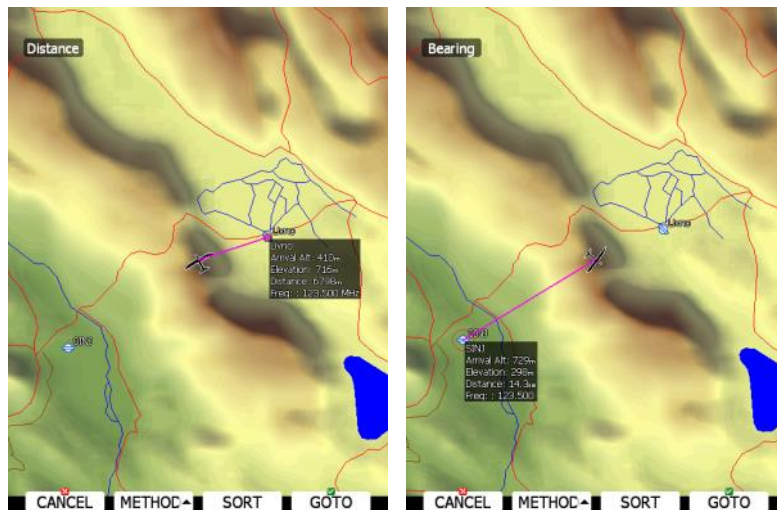

Details of the selected airport will be drawn next to it. In the upper-left corner of the screen current sort method is shown. There are two possibilities: distance sort or bearing sort. Press the **SORT** button to change it.

History mode

History mode shows all previously selected airports and additional two points: take-off location and soaring begin location (not shown on picture below).

Name	Dis.	Brg	Arr
• DIVACA KRASKI UI311	11km	314°	-5688m
• PLOČE	92.6km	149°	-1108m
• UDBINA	123km	316°	-2427m
• Livno	5.95km	48°	-156m
• Take-off location	6.17km	42°	-152m

CANCEL METHOD GOTO

Use the PAGE selector knob to select the desired airport. Press **GOTO** to start navigation to it.



If you are flying a free cross-country flight and you wish to finish it under the OLC rules, you can select a waypoint called Soaring Start, which will show you where to finish the task.

5.6 Waypoint Mode

Waypoint mode is very similar to airport mode. In this mode the user can navigate to waypoints from selected files. In addition to the options in airport mode there are three additional options: Edit waypoint, new waypoint and delete waypoint.



Navigational pages can be customised using LXStyler. The description below applies to the default navigational pages.

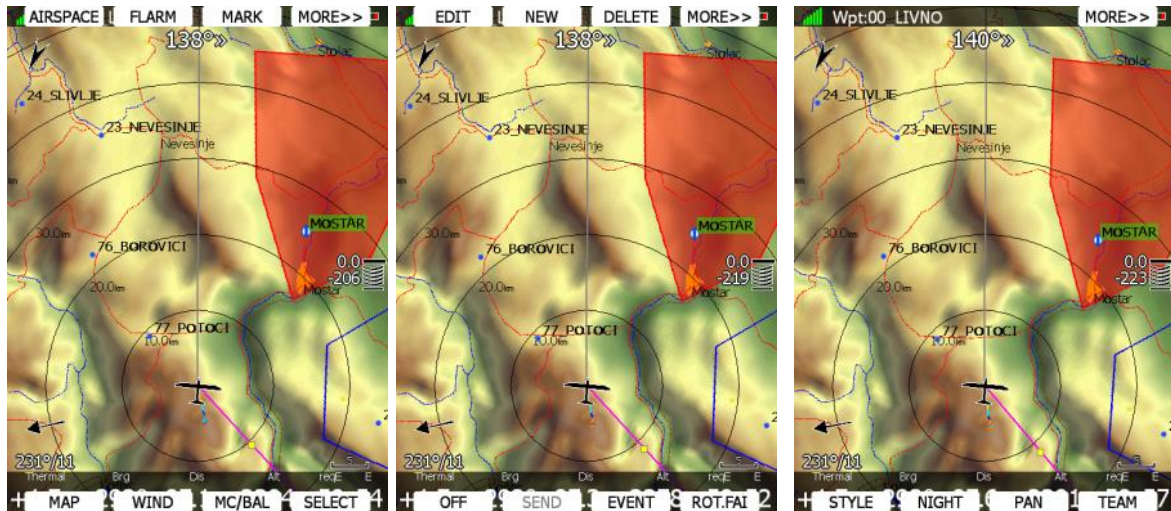

5.6.1 Button Actions Related Only to The WPT Page

5.6.1.1 Editing Waypoints

Press the **EDIT** button. The Edit dialogue will be open with details of the selected waypoint.



There are two possibilities to enter a position. You can modify latitude and longitude to define a position of the point or press the **DIS/BRG** button to enter the position as distance and bearing to a selectable point.

Name		Code	
00 LIVNO		00	
Style		Elevation	
Grass airfield		707m	
To waypoint		Brg	Dis
00 LIVNO		0°	0.00km
RwyDir	RwyLen	RwyWidth	Frequency
130°	800m	---m	

Press the **LON/LAT** button to toggle back to input of latitude and longitude. Modify other attributes at your discretion. When finished, press the **OK** button to confirm changes or press **CANCEL** to dismiss changes. The modified waypoint will be updated in the appropriate file automatically.

5.6.1.2 New Waypoint

Select this option if you want to add new a waypoint to the active waypoints file. If no waypoints file is selected a new waypoint file will be created with name **default.cup**. A message *"Do you want to copy from airport?"* is displayed first. Press **YES** if you would like to copy it from the Airports database. An airport select dialogue will be opened. Select the airport you wish to copy. If none is selected a blank edit dialogue is opened.

Name		Code	
UDBINA		LDZU	
Style		Elevation	
Grass airfield		750m	
To waypoint		Brg	Dis
00 LIVNO		133°	123km
RwyDir	RwyLen	RwyWidth	Frequency
125°	2750m	0m	118.200

The minimum data that must be entered are name, latitude and longitude. Press the **OK** button to confirm changes and create the new waypoint. The new waypoint is added to active waypoint file. Press the **CANCEL** button to abandon creation of new point.



Elevation will be assigned automatically once the position is entered. Elevation is taken from digital elevation model which is stored in the main display unit for the entire world.

5.6.1.3 Delete Waypoint

Press **DELETE** if you wish to delete a Waypoint from your list.



5.7 Task Mode

Task navigation mode is used for task manipulation. Navigation in this page is exclusively to the selected turn point of the declared task.



A task can be created only from stored waypoints or airports. A task can also be loaded from stored tasks. A task can be saved to an active waypoint file (see Chapter 5.1.6.6 for details how to set an active waypoint file). A task used for navigation will also be declared in the IGC file.



Navigational pages can be customised by using LXStyler.

Task mode (valid for DEFAULT profile) has five pages. Use the PAGE selector knob to switch between pages. These pages are designed to suit the needs for racing tasks as well as for assigned area tasks with minimum task time.



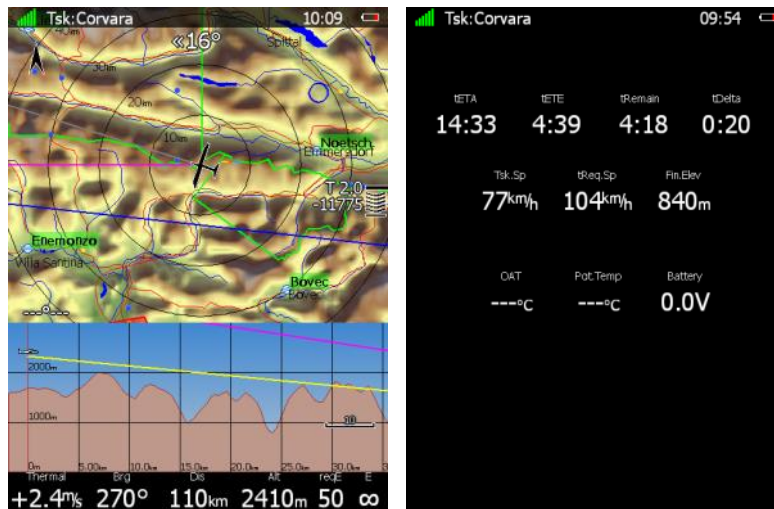

The first page is identical to first pages of the airport and waypoint modes. It shows navigational data to the current turn point. However, the final glide indicator always shows the required altitude to complete the task.

On the **second page** additional data is shown:

- **current net vertical speed**
- **current track** and **groundspeed**
- **tDis** shows the remaining total task distance.
- **tskE** shows the required glide ratio to task finish.

The third page is designed for tasks with time limits which are in most cases going to be assigned area tasks.

Three new symbols are added:

- **Tsk.Sp** which is the task speed achieved up to this moment.
- **tReq.Sp** which is the required speed to task completion. It is calculated as the remaining task distance divided by the remaining time.
- **tRemain:** indicates the remaining task time.

The fourth page is identical to the fourth page of the airport or waypoint mode. It shows the side view.

The fifth page has no map and shows time values for the task being flown and the elevation of the finish point. In addition, outside temperature, potential temperature and battery voltage are shown.

5.7.1 Button Actions Related Only to TSK Page

5.7.2 Task Edit

On the TSK page press the **EDIT** button and the task edit dialogue will open. A task is created and manipulated within this dialogue. A list of task points is shown. In the upper-left corner the type and total distance is displayed. In the upper-right corner the task time is shown (for AAT tasks). Use the PAGE selector knob to select task points or task time control.

There are numerous actions available within the task edit dialogue to make creation of tasks as easy as possible.



Press the **MORE>>** button to see more options.

Available actions are:

- Press the **EDIT** button to enter a new task point, edit an existing one or to enter task time.
- **OK** action will confirm changes to the task and return to the navigational page.
- **CANCEL** action will cancel all modifications of the task and return to the navigational page.
- Use the **ZONE** button to modify the observation zone for selected point. The default zone style is defined in the Observation Zones menu in the setup mode (see Chapter 5.1.8.4).
- **OPTIONS** action will open a new dialogue where additional properties for the task can be defined. The task name is set in this dialogue.
- **VIEW** changes track creation method (see next chapter for more details).
- Press the **LOAD** to load the task from the active waypoint file. You can load a task from SoaringSpot (**S.SPOT**), where you can select an actual contest.
- Press the **SAVE** button to store the task to the active waypoint file. This task can later be loaded from the active waypoint file.
- The **TO NANO** button will be available, if a Nano flight recorder is connected to the main display unit. Press this button to send the declaration to it.
- **INVERT** will invert the complete task.
- **INS PNT** will insert a new point above the current cursor position.
- **STARTS** will open new dialogue, where the user can enter multiple start points.
- **DEL PNT** will delete a point at the current position.
- **CLEAR** will completely erase the task.
- **MOVE UP** is used to move the selected point upwards within the task.
- **MOVE DN** is used to move the selected point downwards within task.

5.7.2.1 View options

There are three different views of creating task: **list** view, **detailed** list view and **map** view. Press the **VIEW** button and scroll to desired mode to change the method (don't click ok). List is your default mode that displays task distance, start, turn and finish points, together with bearing and time (for AAT tasks). Detailed list view is same in all aspects except it also enables you to see coordinates of each point. Map view allows you to view the task on the map and edit zones by scrolling over them (use upper and lower rotatory knobs to do so). If option FAI area is enabled under **MAP** options (see chapter 6.2.1.1), you will also see this area here. When using this view, it is usually faster and easier to first create task in one of the previously described views and then only edit it in map view.

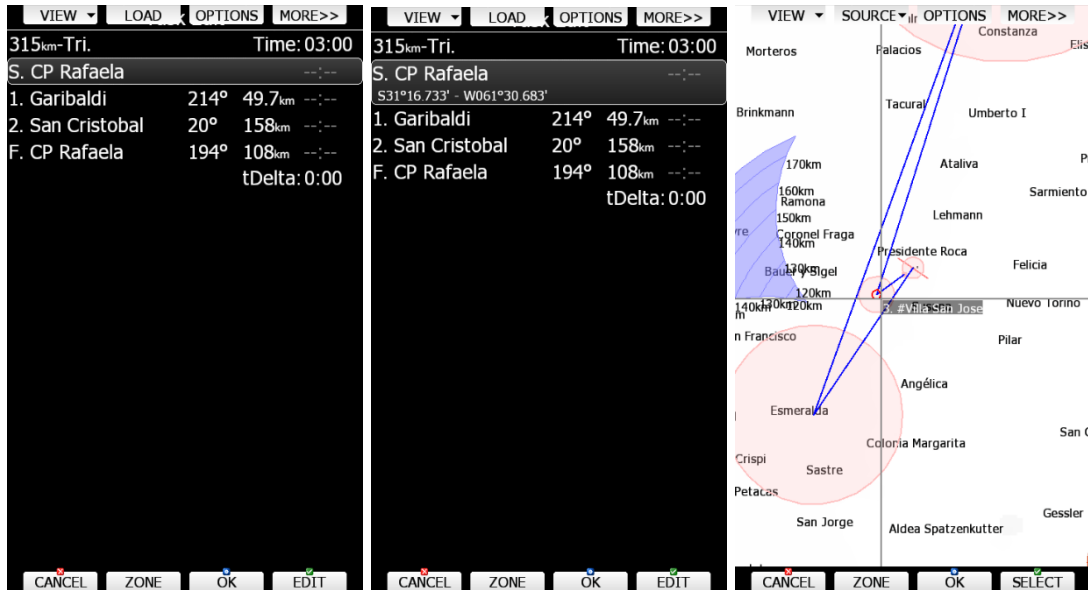

5.7.2.2 Starts (Multiple Start Points)

In some competitions, multiple start points are used for start. Press the **STARTS** button to open the multiple starts dialogue.



The first start point will be greyed out. This is point which is defined in task. Add as many start points as required. Subsequently it is possible to cycle through the start points via the **CYCLE** button.

5.7.2.3 Zone (Modifying Zones)

Select a point and press the **ZONE** button. A new dialogue with the observation zone for the selected point will open.

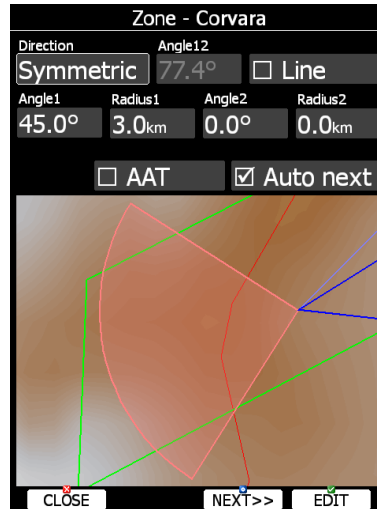

Using parameters in the zone dialogue it is possible to describe all types of observation zones. **Angle12** defines the orientation of the observation zone. Available parameters for **Direction** are:

- **Symmetric:** the most common selection for a turn point.
- **Fixed:** mostly used for assigned areas.
- **Next:** orients the observation zone in direction of the outgoing leg. This is usually used for the start.
- **Prev:** orients the zone in direction of the incoming leg and is usually used for the finish.
- **Start:** orients the sector always towards the start.

If the **Line** box is checked the sector will become a line type of observation zone. The **Radius1** parameter defines half the width of the line length. Use the PAGE selector knob to increase the radius by 0.1 of the selected distance units and the ZOOM selector knob to increase the radius by 5 units.

If **Line** is not checked the **Angle1** parameter will define the basic shape of the observation zone. A value of 180° means that the zone is a cylinder and 45° is the classic FAI sector. Rotate the PAGE selector knob to increase the angle by 0.5° or use the ZOOM selector knob to choose values 22.5°, 45°, 90° or 180°.

Angle2 and **Radius2** are used for more complex observation zone setups.

When changing observation zone parameters, the screen is automatically updated to display the new zone.

Check the **AAT** checkbox if you want to make the selected zone an assigned area. The **AAT** checkbox will be automatically checked when **Radius1** is greater than 10 km.

By default, navigation to task points will be automatically advanced; uncheck **Auto next** if you do not want to change over to next point when reaching selected point. This option will be automatically unchecked when **Radius1** is greater than 10 km.

Press the **NEXT>>** button when you are happy with the changes and to continue with the next observation zone setup.



If the zone is for an assigned area turn point it will be marked with symbol '#' in front of the point name.

5.7.2.4 Task Options

Press the **OPTIONS** button. The options dialogue will be opened.

The 'Task Options' dialog box is shown with the following fields and options:

- Description: [Text input field]
- Navigate to nearest point
- Use start arm mode
- Before start:
 - Gate opens: --:--
 - Below time: ---
 - Below alt.: ---m
- Start procedure:
 - Normal start:
 - Gate int.: 0min
 - Start alt.: ---m
 - Start gsp.: ---km/h
 - Event procedure:
 - Wait before: 0min
 - Start period: 0min
 - Wait after: 0min
 - Max. events: 0
- Finish:
 - Finish is below start for: 1000m
 - Finish elev.: ---m

Buttons: CLOSE, EDIT

Enter the task description. This is very useful during competitions where you are given more than one task per day. Some hints for names are **DAY1-B, Triangle1000km** etc.

Check **Navigate to nearest point** and the system will navigate you to the nearest point on the start zone or start line and finish zone.



The **Navigate to nearest point** option is very useful and actually a must if a finish cylinder is used with a significantly large radius. Enabling this option will calculate the final glide to the edge of the cylinder rather than to the centre of the cylinder.

When the finish line is crossed or the start sector is exited, **use start arm mode** if you want to arm start rather than start manually. When using arm mode, pilot must press the **ARM** button, which is displayed on main navigational screen instead of the **START** button. When the ARM button is pressed a message "Task armed!" will be displayed. The pilot can now start the task. When the start line is crossed or the start sector is exited, the system will automatically advance navigation to the first turning point.

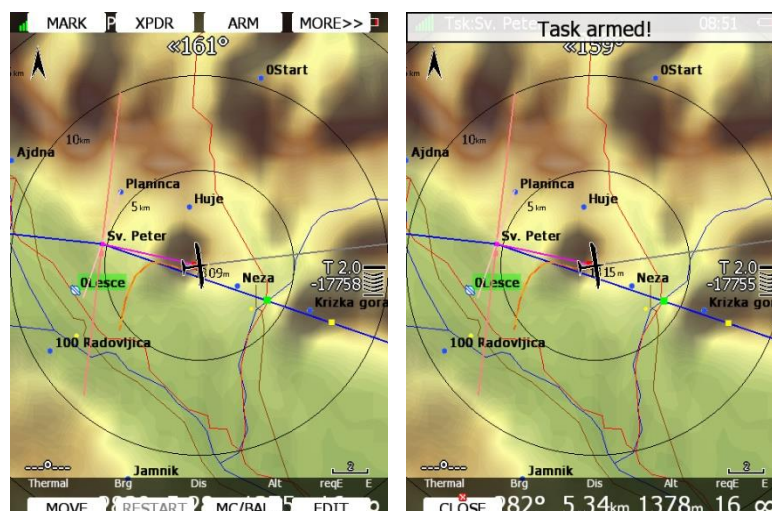

In **Before start** section you can setup when start will open. Setting up this value will prevent user from getting the message "Task started", before task can really be started. In this section you can also adjust bellow time and bellow altitude for special start procedure. See chapter 9.2.1 for more detailed explanation of these parameters.

Start procedure section allows competition pilots to adjust maximum starting altitude, maximum starting groundspeed and gate interval. Gate interval will repeat every set amount of minutes and will open the start for 1 minute each time. Use Start out of the top option for special start procedure used in USA, which allows **start out of the top** of the start cylinder. If **Start within zone** is selected, user can start task in any place inside the starting sector. **Normal start** procedure will start task when crossing the start line.



Start speed and start altitude mode is available only if the **Navigate to nearest point** is checked.

Event procedure is a special start procedure, where event button is used and is described in Annex A to Section 3 – Gliding document, Edition 2020. **Wait before** defines a time period pilot must wait, after pressing event button before he can make a valid start. **Start period** is a time window following wait before period in which start is valid. **Max.events** defines maximum number of pilot events per flight. For more detailed explanation see chapter 9.2.1.

Check **Finish is below start for** when you are making a badge or record flight. If this option is checked the system, it will not navigate you to the finish point elevation as shown in last line but to the altitude which is going to be defined value below the start altitude. If you have set the safety altitude it will be added to this number.

5.7.3 Saving a Task

Once a task is completed it could be saved to the active waypoint file. Press **SAVE** and the message "Task saved" will appear on the screen.

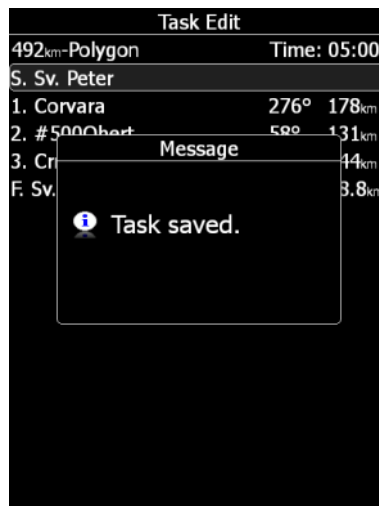

If the task already exists in the active waypoint file the message "Task is already saved!" is shown.

5.7.4 NEW task (Task Creation)

Make sure that at least one waypoint file is loaded into the main display unit and that it is checked and marked as an active waypoint file. Refer to Chapter 0 for details on how to upload waypoint files to the system.

Select task time (if AAT taks) and press the **EDIT** button. Enter the task time if required (AAT). Rotate the PAGE selector knob to increase time in 15-minute steps and the ZOOM selector knob to increase task time in 1-minute steps. Close the task time edit and rotate the PAGE selector knob to select the **first empty point**.

Press the **EDIT** button and enter a turn point name. Entering a point name is very straightforward. Enter the first letter of the task point name using the PAGE selector knob. The "Helper" will show the first waypoint that matches this letter.



Press the **CHAR>>** button and the cursor will move to the second letter. Use the PAGE selector knob to select the second letter. If you want to return to the first letter turn the ZOOM selector knob anticlockwise.

Repeat this procedure until your desired point is selected. Press the **SELECT** button to complete this selection. If you do not know exact name of a point just select the first letter and press the **SELECT** button. Now scroll to the desired point using the PAGE selector knob. Press the **SELECT** button once more to complete this selection.

The task edit dialogue should now look like the screen below. The letter "S" indicates you entered the start point and a letter "F" indicates you entered the finish point.

Move the cursor down to the next empty point and repeat the above procedure until the entire task is entered. Next to the task name bearing to point and distance from previous point are shown. When on ground the time needed from start is shown in last column. On ground calculation for time needed is based on MacCready theory only and it does not take into account wind. If task time is entered, delta time (tDelta) is displayed in last row.

Once a task is started, needed time will change to estimated time of arrival to a point.

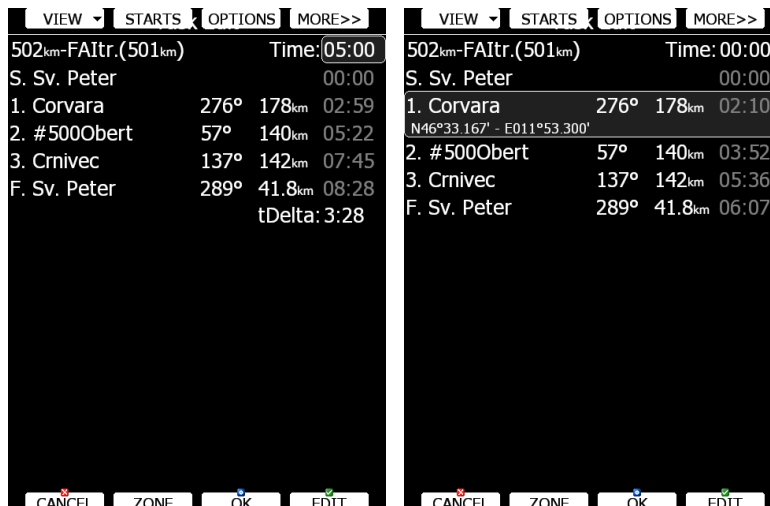

If you would like to change source for selection of waypoints which are used to create task, press the **SOURCE** button and select the appropriate source. There are three options available: **active waypoint file**, **all selected waypoint files** or **waypoint files and airports**.

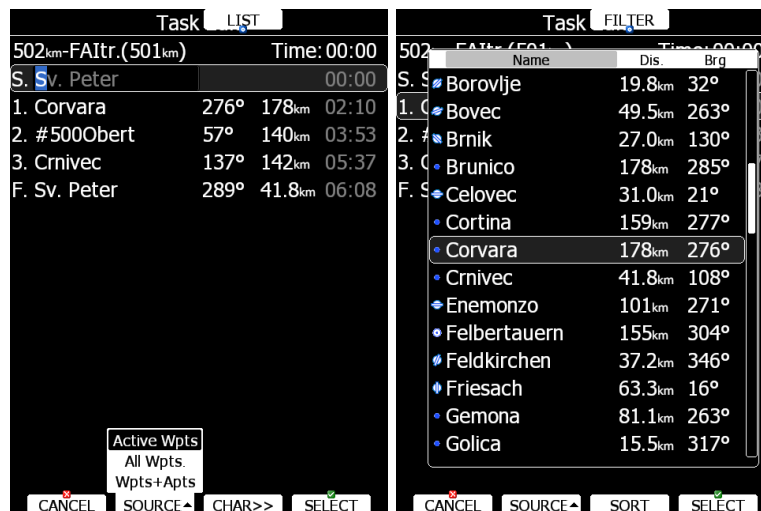

Sometimes it is easier to see a list of all waypoints. Press the **LIST** button to change the selection method to list mode. Press the **FILTER** button to go back to this mode. In list selection mode it is possible to **SORT** waypoints on name, distance or bearing. Distance and bearing are calculated to the previous point in task. This is very useful when you do not know exactly the waypoint name, but just direction and distance and where to go.

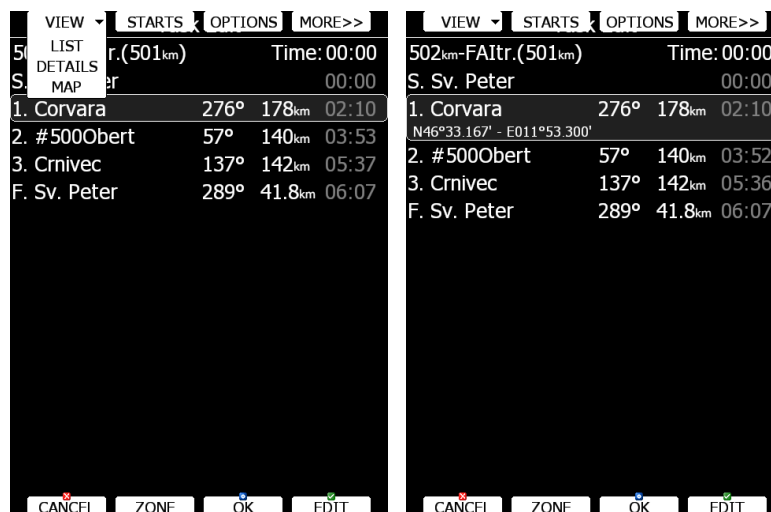

Press the **VIEW** button to change view from list to detailed list view. In detailed list view also, latitude and longitude for selected task point are given. Press the **VIEW** button once more to enter map edit mode.

5.7.5 Creating a Task in SEEYOU

Tasks can be also created in SeeYou software and loaded into LX systems.



For more information about creating a task in SeeYou, please read the manual which can be found here: www.naviter.com

For loading a task into LX system please refer to Chapter: 5.7.6.

5.7.6 Loading a Task

It is possible to load a task from the stored tasks within the active waypoint file. Select the **LOAD** action within task mode. A dialogue with a list of all stored tasks will appear.



Total task distance, task description and task points are shown for each task stored. Select the desired task by rotating the PAGE selector knob and press **LOAD**. The task will be loaded into the active task and the task edit dialogue will be opened.

It is also possible to delete tasks from the active waypoint file. Press the **DELETE** button to delete the selected task.

Tasks can be sorted by start point, task distance and task description. Press the **SORT** button to toggle the sort method.

Loading a Task from Soaring Spot (S.SPOT)

If LX has the Wi-Fi option enabled and has an established internet connection then the S.SPOT button will be available. The user should select the contest and racing classes. By enabling options "automatically download tasks and upload flight" everything will be done without any operation needed on the instrument (if tasks are available and if internet connection is established).

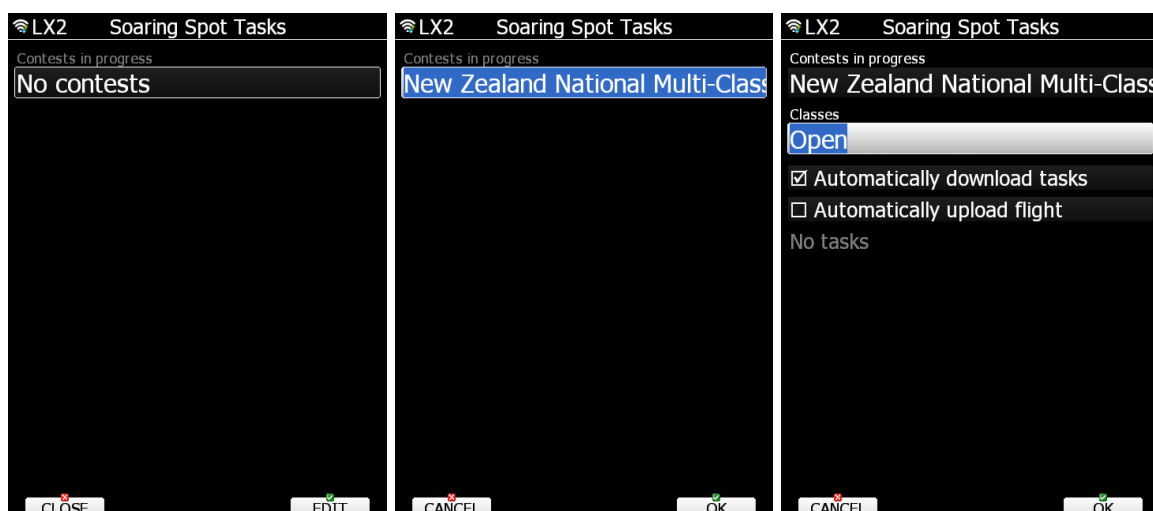

5.7.6.1 Map Edit Mode

In map mode, it is possible to create a task on a map. Use the MODE selector knob to move the grey cross left or right and the PAGE selector knob to move up and down. Turn the ZOOM selector knob to zoom.

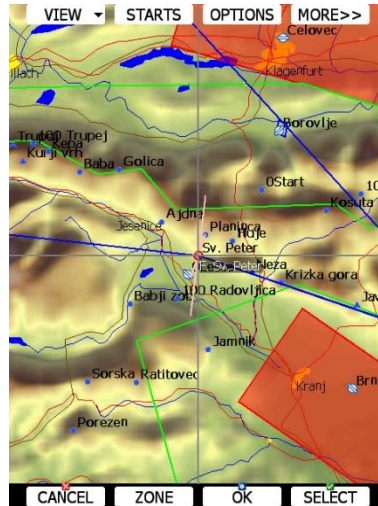

Move the cross to a task point to select it and move it around. Move the cross to a task leg to insert a point.

5.8 Thermal Mode

The system can automatically switch to thermal mode. When the glider enters thermal the device will switch to thermal page and zoom will adjust according to settings set in Chapter: 5.1.7.6.

There can be only one page set as thermal for airport mode, waypoint mode and task mode. You can change the current page to thermal mode in layout settings described in Chapter 6.3.25.

In this dialogue you can enable it and also change track length, colouring of line and zoom of map when in thermal mode.

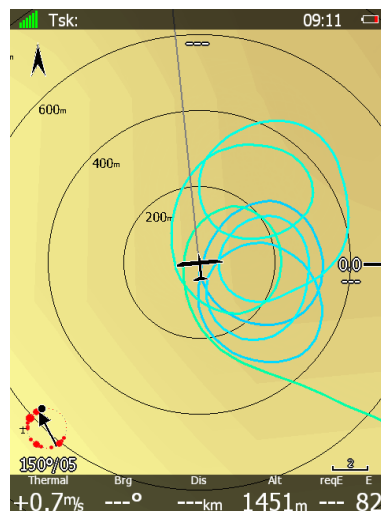

The previous navigational page will be restored when your aircraft stops circling. You can also manually exit thermal mode by rotating the PAGE or ZOOM knobs.

6 Navigational Page Layout

On the main display unit navigational page layout can be completely modified and customized to match user preferences. There are two possibilities for page customization.

- **LX Styler program**, a free program for Windows operating system, which can be downloaded from our webpage www.lxnav.com (see the LX Styler manual for more details).
- The **LAYOUT** option on the main display unit, where you can modify selected navigational pages.



We highly recommend using the LX Styler program instead of the LAYOUT option. **LX Styler** can be used in comfort of your home during long winter period, when you have limited access to your glider. Use the **LAYOUT** option to make quick changes to layout just before going to fly.

In this chapter only, customization on the device will be explained. For more info about LX Styler please refer to its manual.

The navigational page consists of many symbols and navboxes, each of them is fully customizable.

Press the **LAYOUT** button on the navigational screen and a dialogue with several options will appear.

- **EDIT** option will enter page customization mode.
- **DELETE** will delete current page. A confirmation message will be displayed prior to this action.
- **ADD (ABOVE/BELOW)** options create empty page and place it above or below the current one. Newly created pages will then be entered in edit mode.
- **COPY (ABOVE/BELOW)** options copy the current page above or below it. Duplicated pages will then enter in edit mode.
- **SETTINGS** will open a dialogue, where global properties of a navigational page are set. Use this dialogue if you want to change font properties for all the symbols at once.



6.1 Edit Page Layout

When you are in edit mode the selected symbol will be drawn with light blue background. In the top-left corner information about this symbol is displayed. In the middle of the symbol there is cross with arrows drawn, which indicates that symbol is now in move mode. This is also indicated by position label in the information text box in the top-left corner.

Use the PAGE selector knob to move the symbol left and right and the ZOOM selector knob to move the symbol up and down. Rotate the MODE selector knob to select other symbols.

There are several actions available via speed buttons:

- **NEW** will create a new symbol. A dialogue appears with list of available symbols.
- **DELETE** will delete the selected symbol. A confirmation message will be displayed prior to erasing of the symbol.
- **EDIT** action will launch the edit dialogue for the selected symbol. All details for the selected symbol are placed there.
- **RESIZE/MOVE** button will toggle between move mode and resize mode. When in move mode a cross with arrows will be drawn inside the symbol and the position is printed within the information text-box. When in resize mode, two arrows are drawn on the edge of the symbol. They are also showing the direction of resizing. In the information text-box height and width of the symbol are given.
- **CLOSE** action will close customization mode and return to normal navigational mode. A save confirmation dialogue will appear prior to exit.

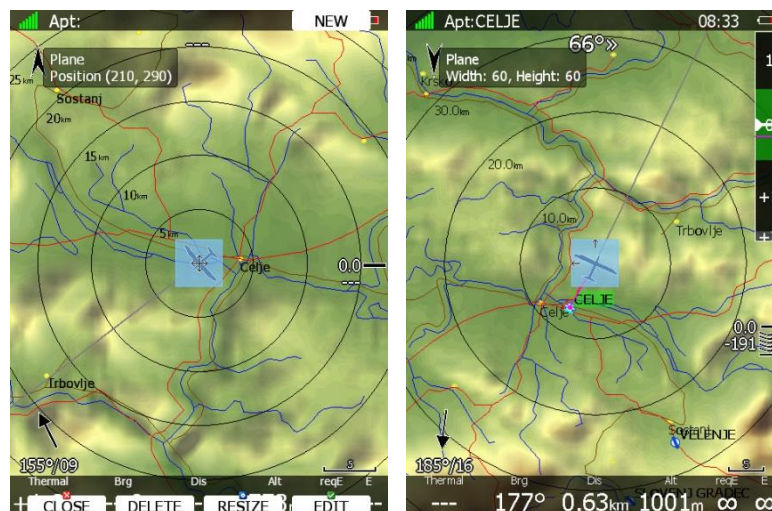

6.2 Button Actions

- **Pan** will change the main display unit to panning mode. In this mode the user can move over the map in all directions.
- **Flarm** will display a list with all visible FLARM objects. You can select one and use it for navigational purposes.
- **Airspace** shows a list of airspace zones in the vicinity (20km in each direction) of the current position.
- **Map** item is used to quickly modify map parameters (see chapter 6.2.1.1)
- **Wind** will open a dialogue where wind changes with altitude are shown, wind can be set and methods for wind calculation are shown. See Chapter 6.2.1.3 for more details.
- **Mc/Bal** will set MacCready, ballast and bugs (see Chapter 6.2.1.1 for more details).
- **Select** option is used to select an airport as the new navigational target.
- **Event** is used to log an pilot event (PEV). The recording rate will be increased to 1 per second for one minute. A message *"Event marked. (1)"* will be displayed on the screen. Number in parenthesis indicates how many times event button was already pressed during flight.
- **Mark** is used to mark the current position and create a waypoint.
- **Rot.FAI** will rotate the FAI area if it is enabled. This option is not shown if it is not enabled.
- **Team** will open a dialogue, where the pilot can enter the team code of his partner. The team code is compatible with the SeeYou Mobile application.
- **Layout** will run the page layout editor. Here it is possible to modify the layout of the current navigational page.
- **Night** will reduce backlight to level acceptable for flying in very dark conditions.
- **Notam** Use this option to view, manage and filter NOTAMs.
- **Xpdr** opens a panel to setup transponder, when this 232 Bridge option is installed.
- **Radio** opens a dialogue to setup the radio, when this 232 Bridge option is installed.
- **Send** is available only when we have a two-seat configuration with a rear-seat device. Press this button to send the current navigational point to the rear seat device. This action will force a change of navigational target for the selected navigation mode on the rear seat device.
- **Off** will switch off the instrument. The message *LX9000 is switching off. Please wait.* will be displayed.

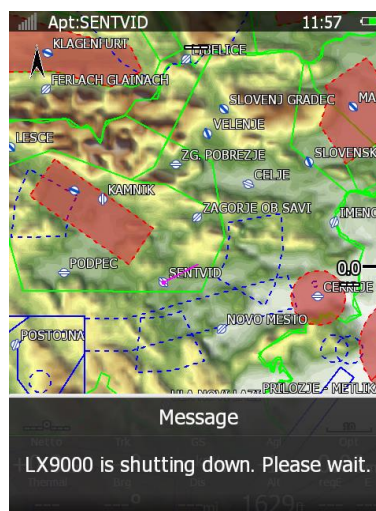

The main display unit can also be powered off by pressing the upper-left button until the message "switching off" appears.

- **Edit** action is used to edit the task. This is the one and only task that will be declared and will be available for navigation.
- **New** button will add a new point. A new point can also be copied from the airports database.
- **Delete** button deletes the selected point.
- **Move** action is used in assigned area tasks to move the navigation point inside the selected assigned area.
- **Restart** is used to restart a task. This action is available only when flying.
- **Cycle** is available when multiple start points are defined and is used to change, cycle through start points.
- **Arm, Start** or **Next** option is used to start a task or to advance to the next turn point.

When any of the eight buttons are pressed, the functions for the buttons are shown. If a selected button is pressed once more the selected action will take place.

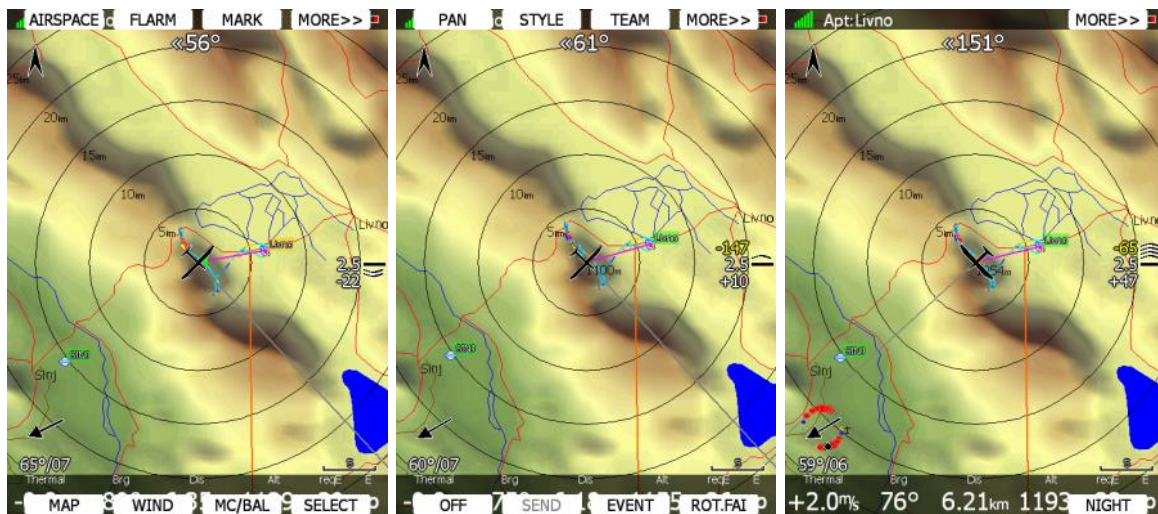

Press the **MORE>>** button to see more options. If the remote stick is available, the behaviour is slightly different. When the check button is pressed on the remote stick a menu will appear instead of the button functions.



By using the UP/DOWN key the pilot may select between the options.



Button functions or the remote menu will disappear automatically after 10 seconds if no further action is taken.

6.2.1.1 MacCready, Ballast and Bugs Settings

These are probably the settings pilots use most often during flight. Press the **MC/BAL** button. The dialogue for MacCready, ballast and bugs will appear.

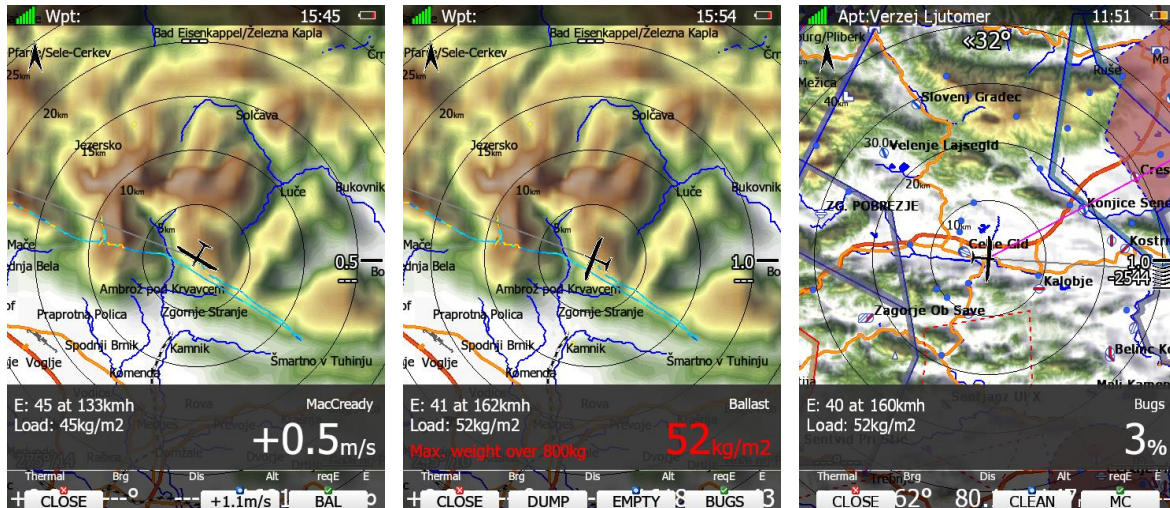

Use the PAGE selector knob to modify the MacCready setting. In the middle button there is a suggestion for the MacCready setting which is based on the last four thermals. Additionally, to the selected MacCready value a wing loading is also shown together with the calculated glide ratio with corresponding speed.



You will notice that the MacCready value displayed on the final glide symbol is coloured yellow or red. The coloured value indicates that your MacCready value is too low corresponding to the current wind and selected target. Increase the MacCready value.

Pressing the **CLOSE** button will close the dialogue and return to the navigation page. Changes will be saved. The dialogue will automatically be closed after 10 seconds if no action is taken.

Pressing the **BAL** button will toggle the menu from MacCready setting to Ballast setting. Ballast is entered in values which are defined in the Units menu (see Chapter 5.1.10.5). You can set the load for an empty glider by pressing the **Empty** button. When parameters for water dump rate are given, the **DUMP** button will appear. Press the DUMP button when you open water valve. The system will automatically count down the amount of water being released. Once you close the water valve press the **STOP** button. This calculation is working only, when all weights are properly entered. Dump function is also available through the remote menu.

If ballast is entered as water quantity in litres, additional button **TAIL** may appear. Use it to enter tail water quantity.



You can also wire digital input to the water valve. In this case the countdown will automatically start and stop. See also Chapter 5.1.12.1 for details on how to define digital input.

Pressing the **BUGS** button will toggle the menu again from the Ballast setting to Bugs setting. A bug setting is used to set polar degradation due to a dirty wing. The input is in

percentage degradation of glide ratio (5% means glide ratio degradation is 5%). Pressing **CLEAN** will set bugs instantly to zero. **MC** will return to the MacCready screen.

6.2.1.2 Map Settings

Map can be quickly configured using this dialogue. Select map orientation in the orientation setup.

A map can have **north, east, west** or **south** orientation. These orientations are fixed and are not changed with glider position. Additionally, to this orientation there are several more which will rotate the map as the glider position changes:

- **Track up** will always have the glider ground track in the up direction.
- **Heading up** will always have glider heading in the up direction. If the compass module is available, the heading will be taken from the compass otherwise the heading is calculated from the wind and the ground speed vectors.
- **Goal up** will have target point in upper part of screen.



Map orientation is setup separately for straight flying or circling. If **Zoom to target** is checked the zoom will be automatically adjusted so that the target point is always visible. Maximum zoom is 200 km and minimum zoom is 1 km. The check boxes will turn on or off the following items:

- **Map** – complete map is turned on/off.
- **Terrain** – only terrain is turned on/off.
- **Raster** – scanned maps is turned on/off
- **Airspace** – toggle airspace display on/off.
- **Wpts** – waypoints drawing is turned on/off.
- **Flarm** – Flarm radar display is turned on/off.
- **Path** – flown path is switched on/off.
- **Cur.trk** – current track vector.
- **Rng.cir.** – range circles
- **Opt.dis.** – optimised distance.
- **Opt.tri.** – optimised triangle.
- **FAI area** – FAI triangle assistant is turned on/off.
- **Gld.rng.** – is gliding range and shows which area is still reachable with current altitude, wind and MacCready setting.
- **Satellite** – will show a satellite picture layer over the map
- **Forecast** – will show a weather forecast layer over the map
- **Rain** – will show a rain radar layer over the map



Satellite, Forecast and Rain layers are seen if LXNAV Connect is activated on the device.



A FLARM object may also be hidden because competition mode is on or privacy mode is on. Please check these settings if FLARM objects are not visible, even if the item is checked.

You can adjust these parameters separately for APT, WPT and TSK pages.

With Software version 7, user can configure all custom map and graphics settings for every page in every mode. **Use only for current page** will affect settings for currently active page, otherwise you will be changing the global style and changes will take effect on all the pages in every mode. **Advance** button allows you to change graphics settings for current page (if **Use only for current page**) or global settings.

To understand it better, you can find an example below of different map and graphics settings for APT mode.

Example:

- APT mode, page 1 (low contrast graphics)

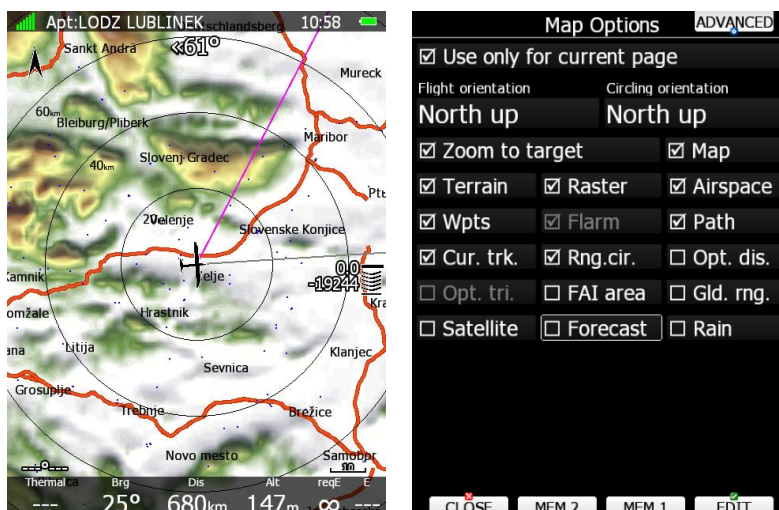

- APT mode, page 2 (ICAO graphics, bigger fonts)

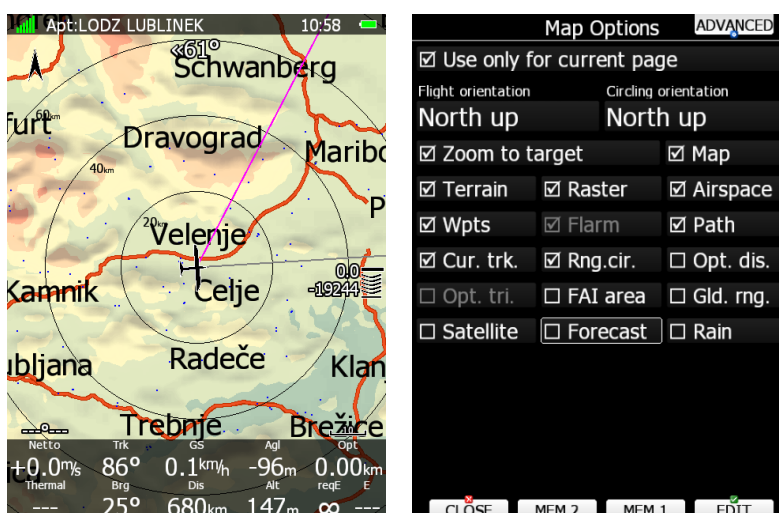

- APT mode, page 3; forecast TopMeteo

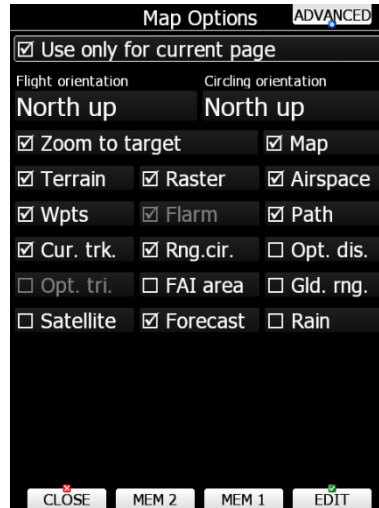
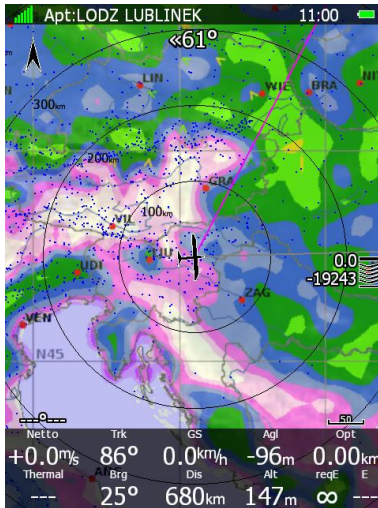

- APT mode, page 4; forecast SkySight

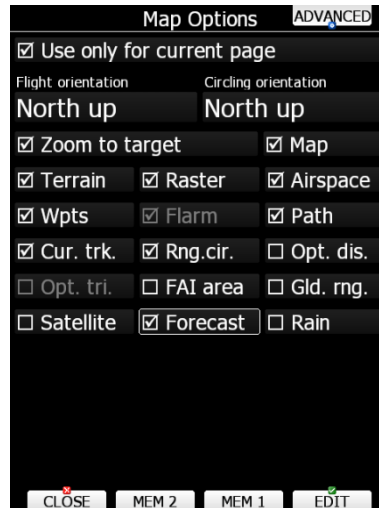
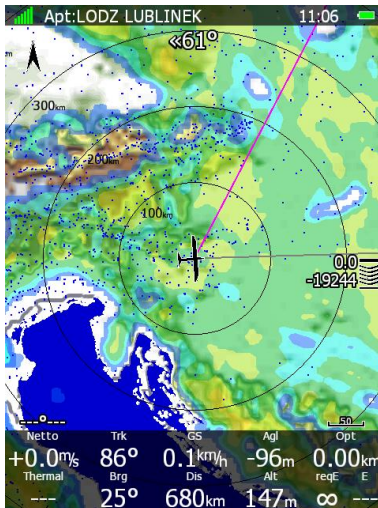

- APT mode, page 5; Satellite picture

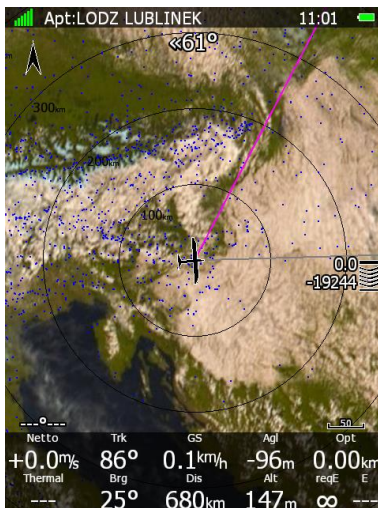

- APT mode, page 6; Satellite picture with SkySight forecast

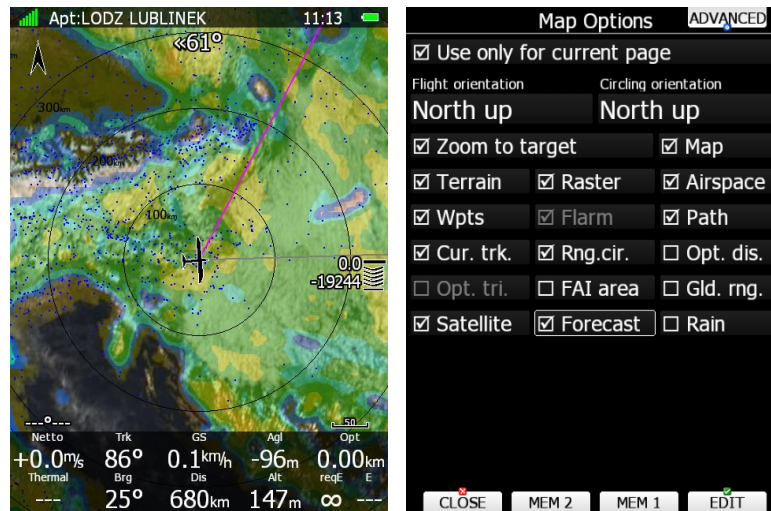

It is possible to store map settings for future use. There are two memory locations MEM 1 and MEM 2 for two different memory settings.

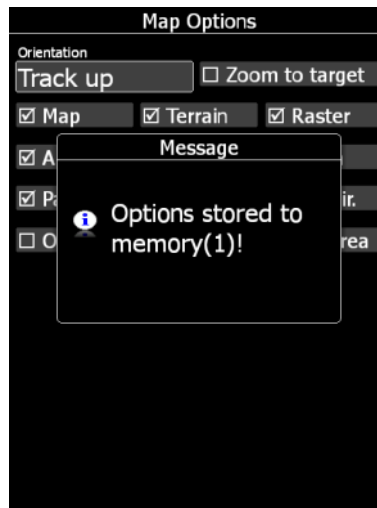

Press button **MEM 1** for a long time. A message "Options stored to memory (1)" will be displayed and the settings are stored. Change the settings a little bit. Press button **MEM 2** for long time. A message "Options stored to memory (2)" will be displayed and the settings are stored to memory location 2. Now short pressing of **MEM 1** will invoke the saved settings from memory 1.

6.2.1.3 Wind

The main display unit constantly calculates wind using four different methods. **Speed difference** method is used during circling and is taking into account ground speed difference in a single circle. **Position drift** is calculating wind based on position drift during circling. A minimum of three circles must be completed to obtain the first wind measurements. The third method is **combination**, which takes into account also airspeed received from the vario unit.

If the **compass** module is available the wind is also estimated using the wind triangle. Calculated wind is stored in layers. Layer height is 300 m or 1000 ft and cannot be modified by the user.

When **HAWK** option is available also **HAWK** method is shown.



On the rear seat device there is additional method called **front seat**. When **front seat** method is selected the device will use the wind calculated by the front seat only and all other methods will be disabled. This will ensure that both devices are using same wind for final glide calculations.

The user can also disable or enable a particular wind method. It is recommended to have all methods enabled.

The wind profile is shown on the left side of the dialogue. Yellow coloured altitude indicates our current MSL altitude. Using the ZOOM selector knob, you can scroll up and down through the wind layers.

Use the **EDIT** button to manually enter wind data. If a new wind direction is entered all wind directions in range from start altitude to end altitude will be modified. The same procedure is used for wind speed.

Once the wind is modified to suit your needs press the **OK** button to accept the wind values.

If you have touch screen, you can also draw wind speed and direction. Below checkboxes for wind methods there is an area, where user can draw a direction and strength of the wind.

The dialogue will exit automatically.

If the **CANCEL** button is pressed the wind dialogue will be closed without applying the changed values.



In double seater configuration, the second seat device can be set to receive wind information from the first seat by ticking the **FRONT SEAT** option.

6.2.1.4 Airspace

The Airspace dialogue shows a list of airspace zones in the vicinity of your position. Vertical and horizontal distances are calculated to all airspace zones in the list. On the right-hand side, you can also see the upper (top number) and lower limit (bottom number) of the selected airspace in feet and meters. Values are marked with FL (flight level), MSL (mid sea level) or AGL (above ground level).

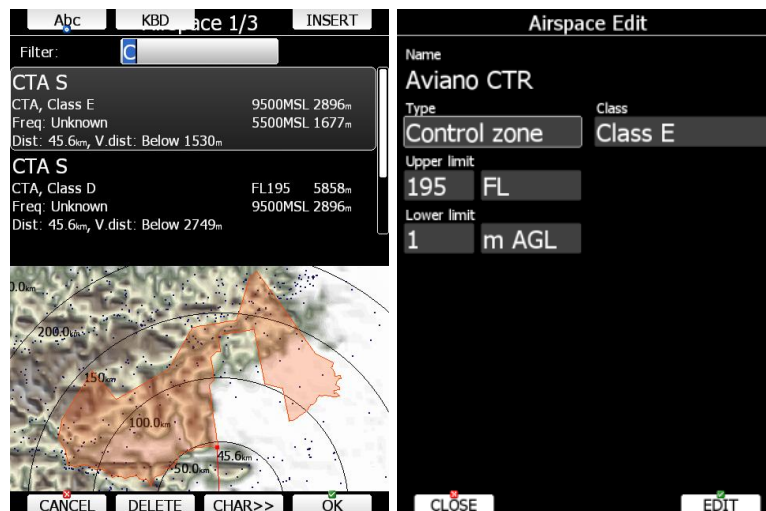

The **VIEW** button toggles the list views. When the **STATUS** button is pressed the status of the selected airspace zone will toggle between **OFF always**, **OFF today**, **OFF hh:mm** and enabled.

If the **EDIT** button is pressed a new dialogue will open where you can modify properties for the selected zone. Refer to Chapter 5.1.6.4 for more details.

When a zone is alarmed the distance will be coloured orange.



Map display of airspace is available only on LX90xx series. The LX80xx series cannot show it due to display size limitations.

Pressing **ALL** will disable all airspaces for TODAY or ALWAYS. To enable them again press ALL and select ENABLE.

Button **FILTER** will show airspaces by inserted name/character.



Press EDIT to edit data for the selected zone. Airspace type, class and altitude borders can be modified in this dialogue.

6.2.1.5 Mark

If you press the **MARK** button a new waypoint will be created with the current latitude and longitude and elevation based on the terrain database. The waypoint name is generated from the current date and time separated by the minus character and preceded by an underscore.

The image displays two side-by-side screenshots of a waypoint editing interface. Both screens have a title bar 'Edit' and a tab indicator.

Left Screenshot (DIS/BRG tab):

- Name: 110111-141033
- Code: [Empty]
- Style: Marker
- Elevation: 3841ft
- Latitude: S24°52.043'
- Longitude: E018°27.880'
- RwyDir: 0°
- RwyLen: ---ft
- RwyWidth: ---ft
- Frequency: [Empty]

Right Screenshot (LON/LAT tab):

- Name: 110111-141033
- Code: [Empty]
- Style: Marker
- Elevation: 3841ft
- To waypoint: KIRIPOTI
- Brg: 343°
- Dis: 178km
- RwyDir: 0°
- RwyLen: ---ft
- RwyWidth: ---ft
- Frequency: [Empty]

Both screens have a bottom navigation bar with buttons: CANCEL, GOTO, OK, and EDIT.

Waypoint data can be modified. Refer to Chapter 5.6.1 for more details. Press the **OK** button to save a marked waypoint or press **CANCEL** to exit without saving. Press the **GOTO** button to navigate immediately to the selected point.

6.2.1.6 Xpdr

This dialogue will be available only when a 232 Bridge is installed and used as a transponder bridge. In this dialogue current squawk, mode and flight level are displayed.

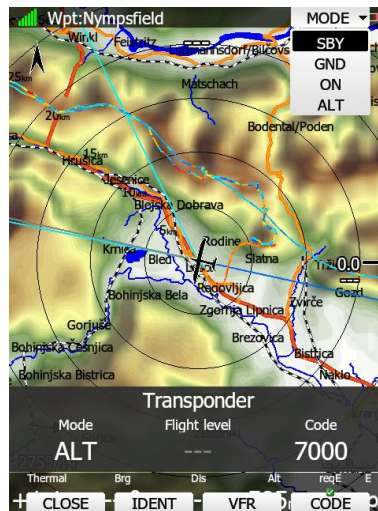

Use **MODE** to select mode of operation of the connected transponder (**STBY**, **GND**, **ON**, **ALT**). Press **CODE** to enter a squawk code. Press **VFR** to automatically set the squawk code to 7000. Press **IDENT** to identify.

6.2.1.7 Radio

This dialogue will be available only when a 232 Bridge is installed and used as a radio bridge. In this dialogue active and standby frequency, transmit status and volume control are shown.

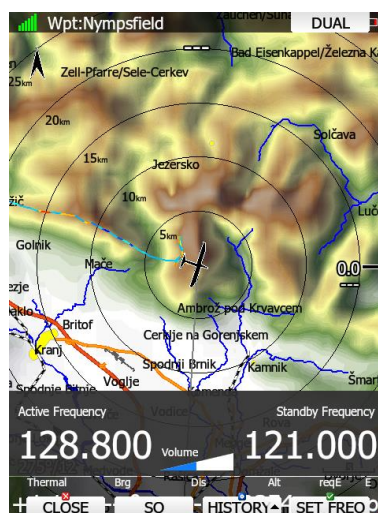

Press the **SET FREQ** button to swap active and standby frequency. Press **SQ** to toggle the volume control between **volume**, **squelch** and **vox**. Use the upper-left rotary knob to adjust it. In the **HISTORY** pull down menu, a list of last ten recently used frequencies is stored. Press **DUAL**, when available, to listen to active and standby frequency simultaneously. Press **8.33 KHz** to toggle between **25 KHz** and **8.33 KHz** channel spacing.

6.2.1.8 Team

The Team feature will help you find or hide your teammate. It lets you share your position with other pilots and even encrypt this information so that your competitors won't be able to decode it.



To use it press the **TEAM** button. First you will have to enter the team reference point. Press **Setup** to select a source waypoint for the calculation. It is imperative that your teammate does the same. If you would like to hide the information from others, enter the Team password. Again, all pilots have to share the same key. When flying you are asked about your position, answer "Hotel-Golf-Echo-Mike". Your teammate will tap the Team button, enter the code and say "Thanks" while others won't have a clue unless they have the key.

6.2.1.9 FLARM

Press the **Flarm** button to view the list of other aircraft received by FLARM. A split screen with the map and a list with all received aircraft since the last switch on is shown.

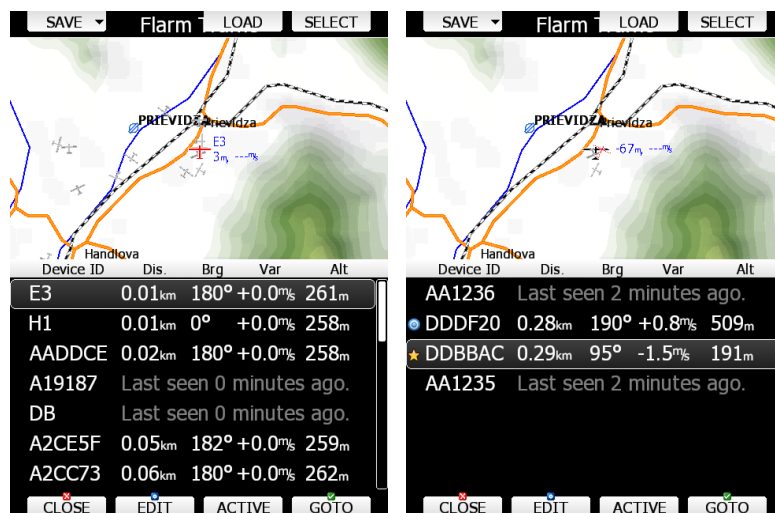

The list is sorted by distance. Device ID, distance, bearing, vario and altimeter parameters are displayed in the list. A lost target is still seen in the list showing when it was lost. Move through FLARM targets using the PAGE selector button. Press the **SELECT** button to mark a selected target as favourite target. A yellow star will be drawn next to it. You can select as many favourites as you want.

One target can be selected as an active target. Press the **ACTIVE** button to make a target the active one. A blue bulls-eye will be plotted next to it. Team navboxes will show distance and bearing to this target.

Press the **GOTO** button to start navigation to this FLARM position.

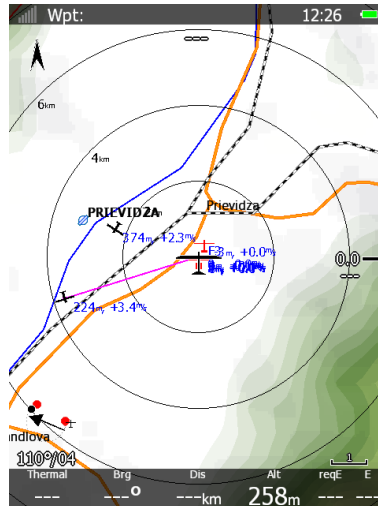

Instead of the FLARM device ID you can also show the competition number for a particular glider. Press the **EDIT** to enter the edit dialogue for the selected FLARM object.

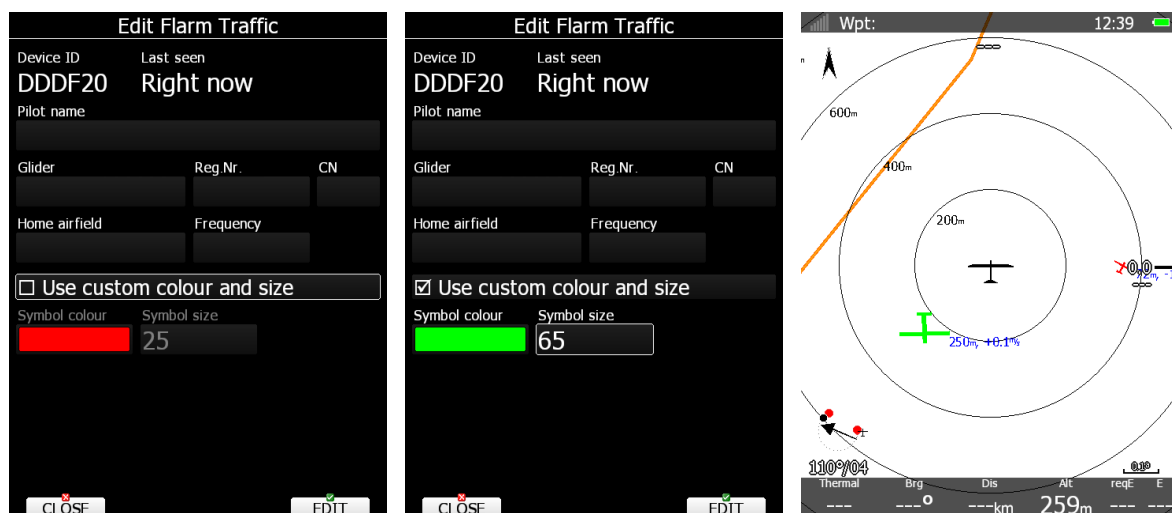

Enter data about the FLARM glider and pilot. The colour and size of each target can be adjusted by ticking the custom box.

The main display unit is pre-loaded with the FlarmNet database to identify known FLARM Device IDs with plane and pilot data. You can upload the latest FlarmNet database after downloading it from <http://www.flarmnet.org>. The update procedure is similar to the update procedure for airport databases. See Chapter 5.1.6.2 for more.

Edited FLARM objects with custom settings can be **saved/loaded** to a SD/USB key. Press the **Save** button to save custom settings to an SD/USB key. The resulting file can be loaded onto other LX80/90 systems with the **Load** button.



We encourage all users to upload their data to the FlarmNet web site. It is very easy. All you need is to determine your FLARM device ID which you will find in the Hardware->Flarm dialogue (see Chapter 13.1.6) and then register at FlarmNet.

6.2.1.10 Pan

Pan mode is a special mode where you can freely move around the map and to zoom in and zoom out to explore details along the course. Press the **PAN** button to active this mode.

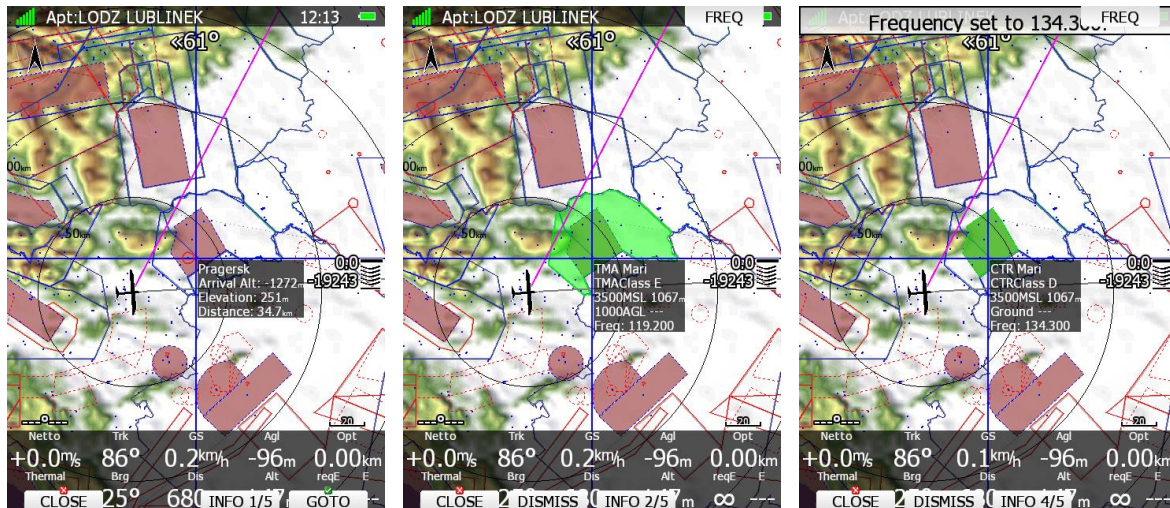

A blue cross will be plotted over the screen with an info box for given cross position. Move the cross up and down on map using the PAGE selector knob. Move the cross left and right using the MODE selector knob. Turn the ZOOM selector knob to zoom.

If a remote stick is being used move the jogger to move the map. Press the **INFO** button to change information for given position of the cursor.

There are three types of information possible: information about waypoint in the vicinity, airspace information and current position.

When airspace info is given, press the **DISMISS** button to dismiss a zone for the selected time period. If Frequency for the current airspace is available and you would like to have it as a passive frequency on your radio (radio bridge is required) you need to press the **FREQ** button. When waypoint or position info is given, press the **GOTO** button to navigate to this point. Press **CLOSE** to leave pan mode.



If a LX80/90xx has a touch option, long press on the map will automatically jump into PAN mode.

6.2.1.11 Rotate FAI Area

This option is used to rotate the FAI triangle assistant to match your suitable position. If the FAI area is not enabled this option will be greyed-out.

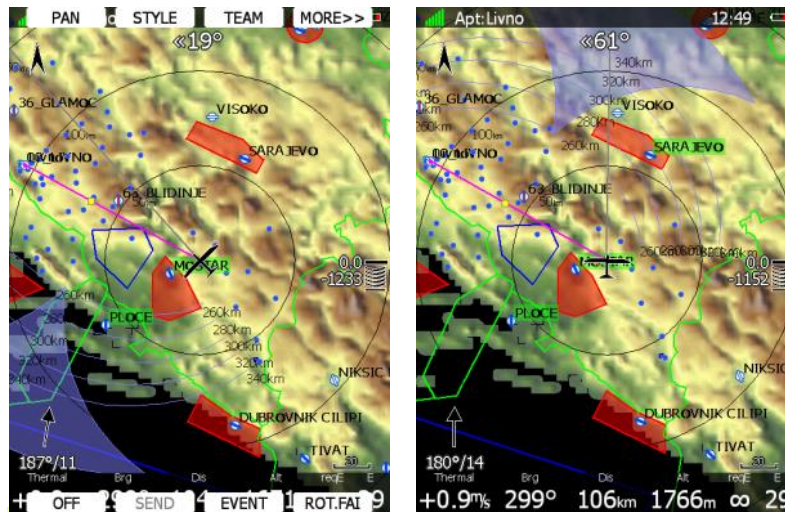

6.2.1.12 Layout

Use this option to modify layout of the navigational page. See Chapter 6 for detailed explanation.

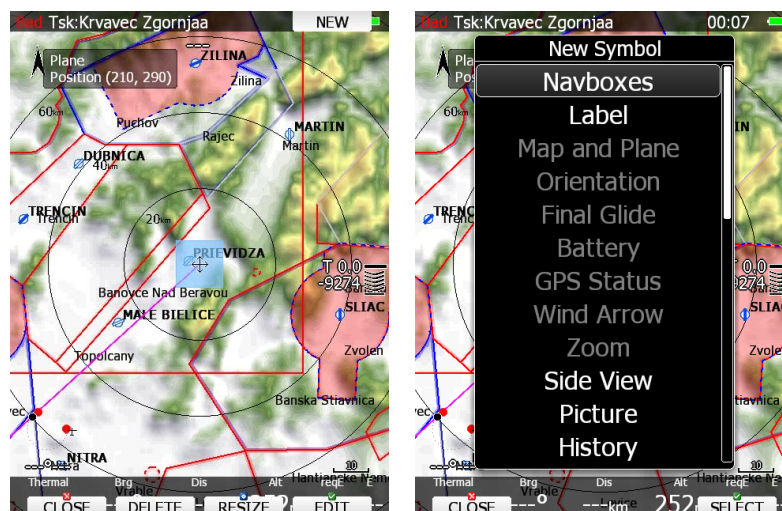

6.2.1.13 Night

Use this option to switch the display brightness to minimum visibility which is suitable for night flying.

6.2.1.14 NOTAM

Use this option to view, manage and filter NOTAMs. For this function you need a GPS AeroData subscription (please visit: www.gps-aerodata.com). The GPS AeroData database contains NOTAMs from the Eurocontrol server, Airspace from national AIPs and customized airspace data. GPS AeroData covers all European countries as well as several FIRs at the borders of Europe and is updated every 15 minutes. The database can be uploaded to the device using an SD-card or USB-stick or via Wi-Fi using the LXNAV Connect Services (see chapter 5.1.4 Airspace and 5.1.14 LXNAV Connect). Editing the graphical display of NOTAMs is the same as with Airspace and can be found in the same GRAPHICS section of the SETUP menu (see chapter 5.1.6.3 Airspace and NOTAMs). When selecting the

NOTAM push button, you will be able to view the list of NOTAMs and sort the list in various ways, reset hidden NOTAMs, and filter NOTAMs.

SORT: the list of NOTAMs can be sorted based on distance, responsible ATS unit, FIR, NOTAM ident and date of creation.

VIEW: allows various layouts of the list including a graphical view.

SHOW ALL: resets all types of hiding NOTAMs.

FILTER: this button leads to a new page that provides various ways of filtering NOTAMs:

- **Show only for today:** NOTAMs not valid on this date will be filtered out.
- **Distance filter:** NOTAMs with a boundary that is further away from the present than the selected value is filtered out.
- **Hide big NOTAMs:** this is a very helpful filter option. With this filter you can filter out irrelevant NOTAMs with a very large radius and a center far away from present position.
- **Don't show above:** NOTAMs with a lower limit above the selected value (MSL) are filtered out.
- **Don't show below:** NOTAMs with an upper limit below the selected value (AGL) are filtered out.
- **Show trigger NOTAMs:** trigger NOTAMs are filtered out by default. Select this option to show these NOTAMs.
- **Show FIR wide NOTAMs:** FIR wide NOTAMs are shown by default. By deselecting this option these NOTAMs are no longer shown.
- **Show Aerodrome NOTAMs:** Aerodrome NOTAMs are shown by default. By deselecting this option these NOTAMs are no longer shown.

6.3 Creating New Symbol

Press the NEW button to add a symbol to a navigational page. A pull-down menu will open.



When a symbol is already included on the page or unavailable, it will be greyed-out. There are several symbols available:

- **Navboxes** are symbols which have numeric value.
- **Label** is just a plain label with text. You can use it for checklists.
- **Map and Plane** will add map and aircraft symbol to the page.
- **Legend** for the data displayed as part of SkySight service.
- **Orientation** symbol is showing direction of north.
- **Final glide** symbol shows the current MacCready setting and information about required altitude. It is highly recommended to include this symbol on navigational pages.
- **Battery** displays status of the power supply.
- **GPS Status** indicates status of the GPS signal.
- **Wind Arrow** shows direction of wind relative to map orientation.
- **Zoom** symbol defines scale of the map.
- **Side View** enables a lateral view of our position toward the selected goal or plane bearing.
- **Picture** symbol will display images bound to the selected waypoint or airport.
- **History** symbol shows aircraft altitude and terrain elevation over past time.
- **Flarm Radar** symbol will display a radar screen showing FLARM targets at predefined zoom.
- **Artificial Horizon** will show an artificial horizon symbol and optional compass points.
- **Altitude Tape** shows altitude with some additional features like on modern primary flight displays.
- **Airspeed Tape** shows airspeed with some additional features like on modern primary flight displays.
- **Vario Tape** is displaying the Variometer value.
- **Magnetic Rose** and **HSI** symbols are displaying magnetic direction.
- **Compass tape** shows magnetic direction.
- **Flaps tape**[®] is unique display of current and required position of flaps. Scale of flap tape matches airspeed tape.
- **3D map** enables display of synthetic 3D terrain. This option is not available in version 4.0 of the firmware.
- **Vario Indicator** symbol is displaying Variometer value.

- **G-Meter** symbol displays current g-load and also minimum and maximum value.
- **Wi-Fi** symbol indicates current status of Wi-Fi signal.
- **Wind Profile** symbol is representing wind profile information very similar to Wind dialogue.
- **Thermal Graph** shows thermals history which are coloured by the MC setting.
- **Meteogram** shows a weather forecast in graphics from selected APT (if available).
- **SC Vario** is an indication of vario mode (speed command or vario mode).
- **Flarm** shows a FLARM indicator on the navigation page.

6.3.1 Navboxes

Navbox is basic element used on navigational pages to display a numerical value for a selected type. Press the EDIT button to edit navbox properties.

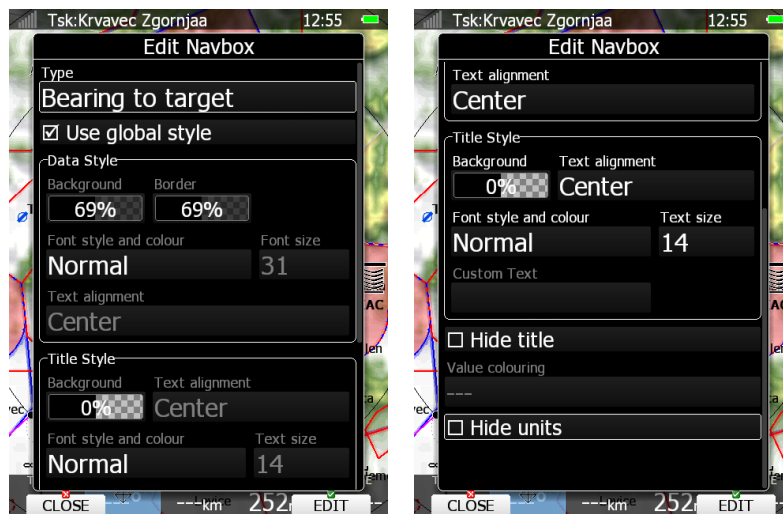

A navbox consists of title, numerical value and unit. Titles can be changed or hidden. In this case navbox will use single global style if the "Use global style" property is checked. You can change displayed units and also hide them. Value unit can be set to AUTO (depends from your main UNITS settings) or you can select the desired one. See the following table for more details.

Navbox titles are sometimes using prefix to identify to which group of navboxes they are belonging. For example: Dist. navbox will show distance to selected target point, tDist will display remaining task distance to finish point and tmDist will display distance to selected teammate. Following prefixes are being used:



- t – for task parameters,
- tm – for teammate,
- req – for required and
- th – for theoretical

Title	Description	Title	Description
60'.Sp	Last 60 minutes speed	Req.Mc	Required MacCready to target
AgI	Height above ground	ReqAlt	Required altitude to target
Airport	Nearest Airport	reqE	Required glide ratio to target
Airspace	Distance to nearest zone	reqFlaps	Requested flaps
Alt	Altitude above MSL	reqSTF	STF for required MacCready
Alt.150'	Altitude 150 minutes ago	RevT	Revolution time – time spent for 1 circle
AltGain	Gained altitude in thermal	Rwy.Dir	Target runway direction
AltGps	GPS altitude	Rwy.Len	Target runway length

AltIGC	Altitude above MSL(source is IGC pressure sensor)	sBrg	Bearing to zone center
Alt.150'	Altitude 150 minutes ago	sDis	Distance to zone center
Analog 1	Analog input 1	sideslip	HAWK sideslip
Analog 2	Analog input 2	Sp.150'	Last 150 minutes speed
Analog 3	Analog input 3	STBY	Passive frequency
Analog 4	Analog input 4	STF	Speed to fly
AOA	HAWK angle of attack	Stopwatch	Stopwatch
Arrival	Arrival altitude on target	Sunrise & Sunset	Sunrise and sunset at target
ArrMc0	Arrival altitude for Mc=0	T.Start Alt	Task start altitude
Avg.Sp.60'	Average speed in 60min	TAF	Target parsed TAF
Ballast	Current ballast	TAF	Target raw TAF
Batt.remain	Battery remain [min]	Target	Target name
Batt.remain	Battery remain [%]	tArr	Arrival altitude for task
Battery	Battery voltage	tArrMc0	Task arrival alt. for Mc=0
Brg	Bearing to target	TAS	True airspeed
Circ.60'	Circling 60min	tDelta	Task delta time
Circ.Flt	Circling Flight	tDis	Remaining task distance
Circ.Tsk	Circling Task	tETA	Task estimated time of arrival
Code	Target code	tETE	Task estimated time enroute
COM	Active frequency	Th.Dist	Distance between thermals
curFlaps	Current flaps	Th.E	Thermal glide ratio
cWind	Cross wind component	Th.Path	Flown distance between thermals
Date	Local date	thE	Theoretical glide ratio
Description	Target description	Thermal	Last thermal vertical speed
Dew.Temp	Dew point temperature	Time	Local time
Dis	Distance to target	TimeLeft	Time left on task
E	Current glide ratio	TkOff	Takeoff time
Elevation	Target elevation	tmAlt	Team partner altitude
Emc	MacCready glider ratio	tmBrg	Team partner bearing
Energy used		tmCode	Team code of my position
Eng.TT	Engine total time	tmDist	Team partner distance
Eng.FT	Engine flight time	tmName	Team partner name
ETA	Estimated time of arrival	tMinDis	Task minimum distance
ETE	Estimated time en route	tMaxDis	Task maximum distance
Fin.Elev	Task finish elevation	tmRelAlt	Relative altitude of teammate
FL	Flight level	tmTo	Relative bearing of teammate
Fl.E	Flight efficiency	tmVario	Team partner vario
Flarm	FLARM RXTX	tmWptcode	Teamcode for waypoint
FIIGC	Flight level from IGC pressure sensor	To	Steering course to target
FltTime	Flight Time	toWind	Head/tail Wind to target
Frequency	Target frequency	tRemain	Task remaining time
g-load	Current g-load	tReq.Mc	Task required MacCready
g-max	Max. g-load	tReq.Sp	Task required speed
g-min	Min. g-load	Tri	Optimized FAI triangle or just largest triangle
Gnd	Terrain elevation	Trk	Ground track
GS	Groundspeed	trqSTF	Task STF for required MacCready

GS-TAS	Groundspeed – TAS difference	tunAlt	Task uncompensated arrival altitude
Hdg	Heading	Tsk.Sp	Task speed
Height	Height above takeoff point	tskE	Task required glide ratio
Humidity	Relative humidity	tVario	Average vario for task
IAS	Indicated airspeed	UTC	UTC time
liveWind	Live wind direction and speed	VarA	Average vario for last 20 seconds (20 seconds is default time, which you can set in vario parameters)
LON/LAT	Longitude and Latitude	Vario	Current/actual vertical speed of a glider
Mc	MacCready Value	vario avg	HAWK average vario
METAR	Target parsed METAR	VarioFL	Average vario for flight
METAR	Target raw METAR	VMG	Velocity made good
Netto	Current Netto-vertical speed of the air mass	Waypoint	Nearest Waypoint
netto avg	HAWK average netto	Weather info	Time and name of currently displayed weather layer.
OAT	Outside temperature	Wind	Current wind
OLC.Sp.60'	OLC 60' Speed	WindX	Side Wind Component
Opt	Optimized distance	XPDR	XPDR Transponder
OptHome	Optimized distance to home	xTrk	Task cross track distance
Pot.Temp	Potential temperature	xsDist	Cross distance to zone centre
QNH	QNH setting	Rain age	Shows the time of last received rain picture
Radial	Radial from target	Rain time	Shows relative time of the rain picture
Radius	Circling radius	RawIGC	Raw altitude from IGC pressure sensor (Above 1013 level)

6.3.1.1 Detailed Description of NAVBOXES

Title	Description
E	The current glide ratio calculated over 3 minutes. Total altitude is taken into account and distance is calculated over one point.
Emc	Best final glide ratio at chosen MacCready, same as displayed in the MacCready/Ballast/Bugs dialogue.
Req.Mc	Required MacCready value to reach the selected goal at safety altitude. If this value is negative, the arrival altitude is shown.
Th.E	The thermal to thermal glide ratio. Calculated from last thermal exit to current thermal entry altitude. Total altitude is taken into account and distance is calculated over one point.
thE	Theoretical glide ratio for given MacCready and head/tail wind.
STF	Speed to fly for selected MC. It is the same number as in the MC dialogue
ReqSTF	It shows you the speed, to arrive on the WPT at your desired altitude (reserve is calculated). Example: if your FG is very much in +, it will tell you how fast to fly to use all the energy(height) to arrive at desired altitude.
TrqSTF	Same as reqSTF, except that it over all WPT on the task to the finish point.
Thermal	Thermal shows an average vario from entering the thermal, after leaving the thermal it shows an average from the last total thermal.
Pot.Temp	Potential temperature calculated to the mean sea level and can be helpful with identifying if there is enough heat to trigger thermals and how strong they might be.

VMG	Velocity made good is a speed to the waypoint. Example: if your TO shows 30>>, it means you are flying 30 degrees away from the Waypoint and if you fly at 100kph, your VMG will show you a speed of 86 kph. If you are flying 60 degrees away, your VMG will show you a speed 50kph and if you will fly perpendicular to the point, your VMG will be 0.
TMinDis	Is a minimum possible task distance from your position to the finish at AAT.
TMaxDis	Is a maximum possible task distance from your position to the finish at AAT.
tunALT	Task uncompensated arrival altitude doesn't calculate additional kinetic energy, which you have as you are flying faster than best polar speed.

6.3.2 Map and Plane (Plane Symbol)

The plane symbol shows the current position and direction on the map. It will always be automatically added and deleted together with the map.

Plane has two different position settings. The symbol is placed in one position when the map orientation is North up, East up, South up or West up and in the other position when current orientation is Track up, Goal up or Heading up. Depending on settings, the position of the plane can automatically change when circling.

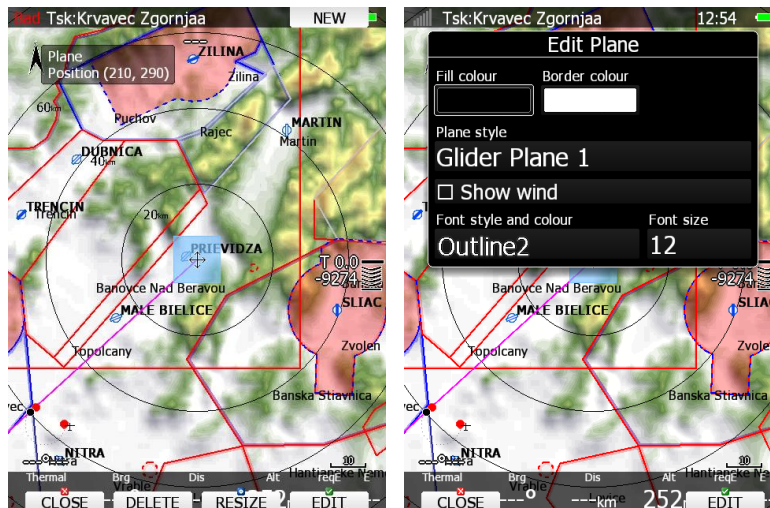





















There are several representations of the plane available. Change style to select a different plane symbol. You can also add a live wind or average wind indication which will rotate around the symbol. Enable it by checking the Wind property. Average wind is calculated from all available wind methods.



When **HAWK** is running, live wind will be coloured light blue. In next table symbols displayed on the map are shown.

Symbol	Description
?	Unknown type of point
●	Default waypoint symbol
▲	Mountain top

	Outlanding place with known direction
	Outlanding place with unknown direction
	Grass airfield with known runway direction
	Grass airfield with unknown runway direction
	Glider site
	Solid airfield with known runway direction
	Solid airfield with unknown runway direction
	Mountain pass
	Sender
	VOR
	NDB
	Cooling tower
	Dam
	Tunnel
	Bridge
	Power plant
	Castle
	Intersection
	Marker, temporary point
	Control point

6.3.3 Orientation Symbol

Orientation symbol shows North direction.



6.3.4 Final Glide Symbol



The final glide symbol is a complex symbol. The bottom number shows your predicted arrival altitude. Negative numbers indicate that you are below the glide path and positive numbers indicates you are above the glide path. In the above example the glider is 226m above the glide path. Chevrons show the position relative to the required glide path in percent. One arrow means 5% above or below final glide. The middle number is the current MacCready setting. In task mode it is prefixed with the letter **T, A, B, G, S, U** or **AG**. Sometimes there will be another number above MacCready in yellow colour, which is used for arrival over terrain. If we are on final glide to a selected target but between it and the current position there is terrain which cannot be crossed without more height, then this

number will give you an estimate how much you must climb to pass over the terrain. A **red** rectangle will also be shown on the magenta line indicating the point of potential collision. In above example we have to climb 544m in order to cross terrain.

6.3.4.1 Final Glide Character Explanation

The character "**A**" will be displayed before the MacCready value if a start altitude was entered and/or the character "**G**" will be displayed if a start speed was specified. **AG** combines both **A** and **G**. See Chapter 5.7.2.4 how to enter start speed or start altitude. On example below, glider will reach start line 212m above required altitude and current speed is 108kph.



At some competitions there is a rule that a pilot must be below a defined altitude for a certain amount of time. Enter **Below alt.** and **Below time** to use this option. An indication will be given on the final glide symbol. Character "**B**" will be displayed before the MacCready value which indicates that the final glide is in below altitude mode. See Chapter 5.7.2.4 how to enter below time and below altitude. On example below, glider must be below specified altitude for 17 seconds. At the moment glider is 228m below specified unit.



The Character "**T**" means TASK, which means final glide to finish on task. Picture shows we are almost on final glide for task over all remaining points.



The Character "**S**" means START, which means final glide to the start line.

The Character "**U**" means UNCOMPENSATED, which means the extra energy which you have with the speed above best glide speed is not taken into account when calculating final glide. It appears when you are close to the finish line. In picture below, you would be 245m above final glide to task finish taking into account extra kinetic energy. If finish is at 200m, your current altitude is 436m.



If **EVENT** button is pressed, Wait time counter is seen in orange colour about the Mc value. Once wait time counter counts down, a start window will open and count down for start window is displayed in white colour above the MC value. Number next to letter "E" indicates how many pilot events are already recorded in IGC file.



According to latest completion rules (November 2020), maximum number of events is three. This value can be set in task options. See chapter 5.7.2.4

6.3.5 Battery Indicator

Battery will visually display the current level of the battery. Green indicates that battery is ok. It will turn yellow and later red when the battery is empty. Battery symbol colours are related to the battery voltage which can be set in Chapter: 5.1.12.15.



6.3.6 GPS Indicator

GPS shows the status of the GPS signal. Green colour indicates that GPS is acquiring a 3D position and yellow colour stands for a 2D position fix. When red, no position is calculated by GPS. Each bar represents two visible satellites. If the symbol N.C. is present, there is no GPS connection/detected.



6.3.7 Wind Arrow and Thermal Assistant

The wind symbol shows the wind direction. A black arrow shows combined wind information (position drift, speed difference and combination method). A grey arrow is a live wind. When **HAWK** is running grey arrow will become light blue coloured. The number represents the average wind measurement. Around the wind symbol a thermal assistant can be shown during circling. Enable or disable this feature via the "Has Thermal" property.

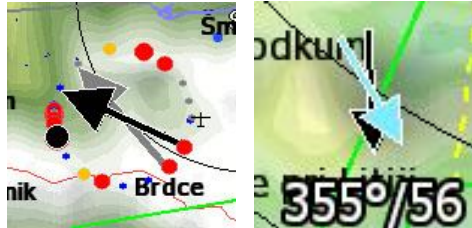

Wind arrow can be configured in the LX Styler or on the instrument. On the instrument, you need to go to LAYOUT and select the Wind symbol. After pressing EDIT it is possible to change the colour for the current/average or both Wind arrows.



Wind direction and strength can also be shown around plane symbol. See chapter 6.3.2 for details.

There are few Wind navboxes which can be very useful.

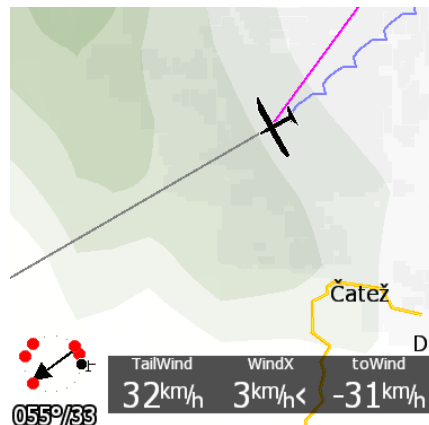

cWind: Head/Tail wind component

WindX: Side wind component

ToWind: Head/Tail wind to target

The thermal assistant continuously analyses the thermal whilst circling. The sizes of the dots indicate the strength of the thermal. Big dots mean stronger lift at that point. On the left or right side of the circle a small airplane symbol is shown. This airplane indicates your position. A black dot indicates the thermal maximum. The pilot should extend the circle when the black dot is about 60° away from glider. This value varies and depends on the turn rate of the glider and type of thermal. All other dots are coloured based on the MacCready setting. Red colour means values above MacCready, blue values below

MacCready and yellow dots represents lift about the same strength as the MacCready setting.

This colour scheme gives us hints about a thermal at glance. If most of dots are red we should consider increasing the MacCready value; if most of dots are blue we should consider decreasing the MacCready setting.

Colour scheme can be changed in 5.1.7.6 Thermal Mode menu.

6.3.8 Zoom

The zoom symbol shows the current map zoom. It can be used only when the map symbol is already on the page. Zoom can be presented in two ways: a number on the symbol indicates the length of the zoom symbol or the number indicates length of the whole screen. You can toggle the "Show full screen distance" property to change this setting. The displayed value is given in distance units (km, nm or mi).



6.3.9 Side View

This symbol shows the lateral view of our position towards the selected target or bearing of the glider. It shows terrain and airspace in that direction.

A grey line represents the projected track based on the glide ratio. A yellow line is showing the requested glide ratio to goal based on zero MacCready setting and a magenta line shows the current MacCready setting.

You can change the appearance of airspaces in the Setup > Graphics > Airspaces settings dialogue.

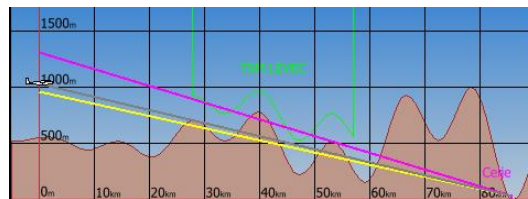

Safety altitude that you set under the QNH and RES in the setting menu is already included into the projected lines.

6.3.10 Picture

Waypoint files with extension .cupx include also pictures for specific waypoints which can be displayed if this option is enabled.



6.3.11 History

With History symbol you can see the flown path of the whole flight or just some last minutes of it. By default, it shows the complete flight. The symbol displays the altitude of aircraft and terrain.

By default, circling to the left is coloured in orange and circling to the right is displayed in yellow colour.

On the left side there is a blue marker that indicates the current position and change in position in last 20 seconds.

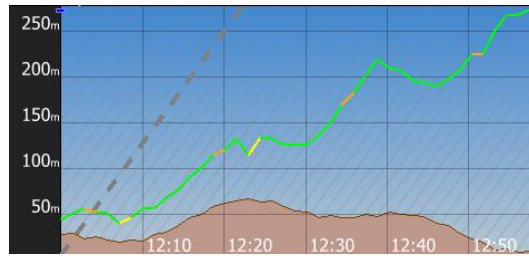

6.3.12 FLARM Radar

A radar screen will show FLARM (and ADSB) targets at a predefined zoom. You can change the zoom in the edit layout dialogue, or you can rotate the ZOOM knob to change it. This will work only if the map symbol is not on the current page.

There are also ascending slopes drawn with grey colour. This indicates the MacCready values.

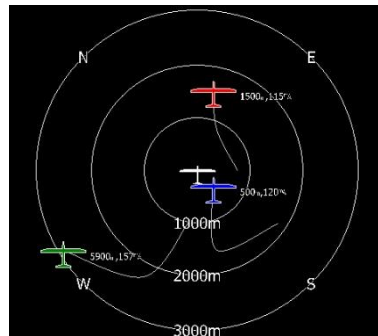

6.3.13 Artificial Horizon

The artificial horizon symbol together with speed tape and altitude tape make a very sophisticated primary flight display out of your main display unit.

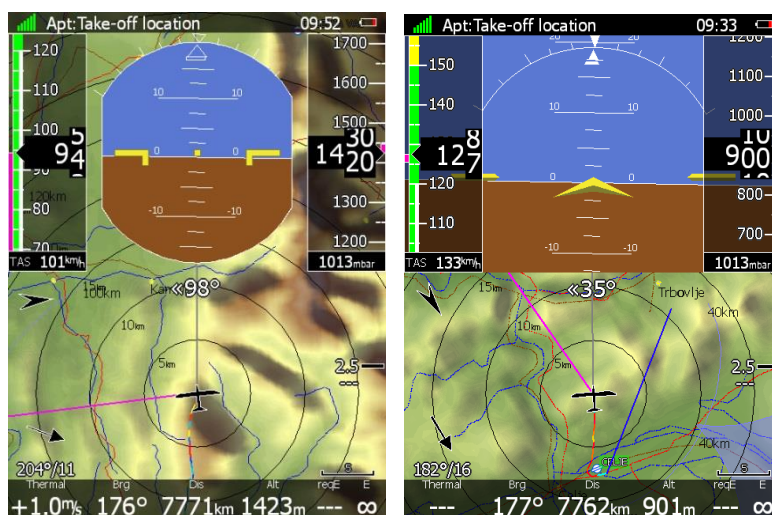

The shape of the symbol can also be customized. You can also enable the display of sky directions with checking the "Show compass" property.

6.3.14 Altitude Tape

The altitude tape comprises an altitude band with the current altitude in the middle. Additional to that a trend vector is displayed. You can also customize the tape's top and bottom boxes to display current QNH setting, AGL altitude, flight level or MSL elevation. The nearest airspace marker is also drawn on the tape. In task mode instead of airspace elevation the task finish point is shown. The latest thermal is drawn on the tape with an appropriate colour. Yellow tape shows an arrival altitude for Mc setting MC = 0. Green tape shows an arrival altitude for selected MC setting.



6.3.15 Airspeed Tape

The airspeed tape shows the current indicated airspeed. A blue-green marker on the tape represents the speed to fly value. Band colours are fully customizable to match your aircraft speeds, see more in Chapter 5.1.13. Additional to that a trend vector is displayed. You can customize the tape to show current true airspeed, groundspeed or outside temperature inside the top or bottom boxes.



6.3.16 Vario Tape

The Vario Tape displays variometers values. Font size, font style, text alignment and round corners can be adjusted.

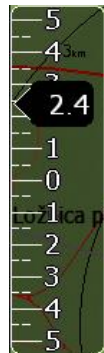

6.3.17 Magnetic Roses and HSI

The magnetic rose and HSI symbols display the compass. The magnetic rose cannot be detached from the plane symbol while HSI can be freely moved. HSI always points in the heading direction. HSI also displays additional information.

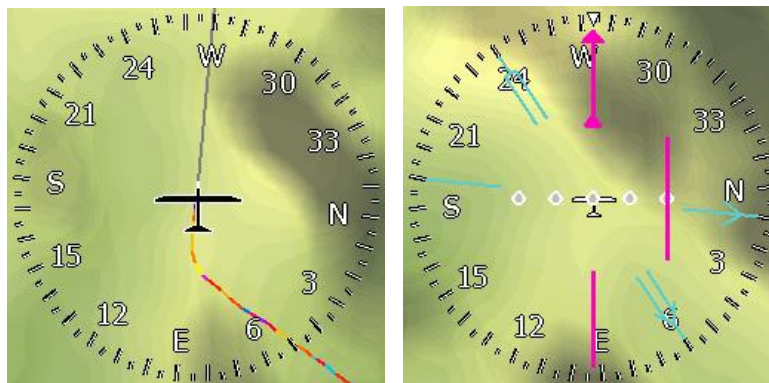

6.3.18 Compass Tape

The Compass Tape shows the magnetic direction. The user can set pointer colour and compass scale.



6.3.19 Flap Tape®

The flap tape displays current and required flap positions. The scale of the flap tape matches the airspeed tape.

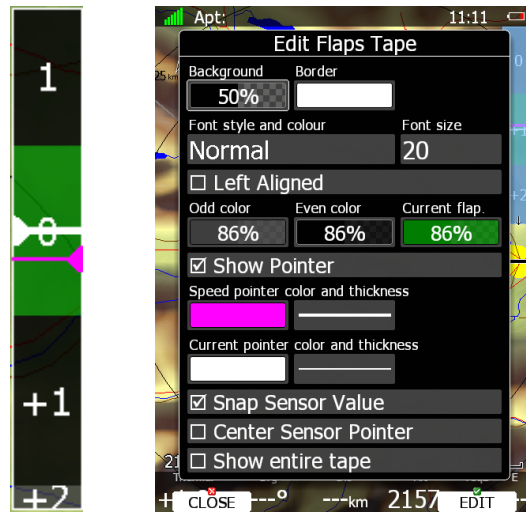

The magenta pointer shows the required flap setting. A white pointer shows the selected flap position. The Selected flap position band is coloured green when matching flaps are set. When wrong flaps are set the selected flap band will be coloured red. When the property "Show entire tape" is set, all bands are visible and have equal size regardless of their configured speed bounds.

If Snap Sensor Value is ticked, flaps will also show the current flaps setting and required flaps setting. To calibrate the flaps settings properly, refer to the Chapter: 5.1.12.14.



System will be able to display a suggested flap position based on current wing loading and g-factor.

6.3.20 3D Map – Synthetic View

The synthetic view shows 3D terrain including rivers, streets, roads and airspace. FLARM traces can also be seen in the 3D view.



6.3.21 Vario Indicator

The Vario Indicator symbol displays Variometer values. While the Vario Tape only shows the speed trend value, the indicator displays more information.

The orange needle pointer on the meter can indicate vario, netto, relative or the speed to fly value, depending on your settings and current mode. On the right side there is an icon that displays the current mode. When in Vario mode a circular arrow will be drawn and in SC mode straight ascending line will be shown.

A red diamond shows the average vertical speed. A blue arrow shows the current MacCready value. The green T pointer shows the last thermal average value.



6.3.22 G-Meter

The G-meter symbol shows the current g-load value. It also displays the minimum and maximum g-load. Initially the, symbol is always visible, but it can be hidden automatically when below a certain value. You can configure this behaviour by changing the "Show above" property.



6.3.23 Wi-Fi Indicator

Show status of the wireless network connection. Symbol changes as described below:



No Wi-Fi option installed or module present and no Wi-Fi networks detected



Module not present, not detected or faulty



Not connected, Wi-Fi networks in range



Connected, good signal. White lines indicate the strength of the signal.



Connected, bad signal.



Connected, good signal, no internet access. Please check your internet access point (router, mobile hotspot...).

6.3.24 Wind Profile

The wind tape symbol shows the wind. You can see the wind direction and speed at different altitude bands. This information is depicted graphically with an arrow on the left side and with values on right side. The current aircraft altitude is indicated by a yellow horizontal line. You can also see the wind profile in Wind dialogue. Here you can also manually change values.



6.3.25 Thermal Graph

The Thermal Graph shows thermals statistics during the flight. It shows the point of entering and leaving the thermal and where thermal was the strongest and the weakest. A numerical value below each thermal column shows the thermal vario between the first and last circle of the thermal. Colours are related to MacCready settings. Thermals are coloured based on the MacCready value. Red colour means that the thermal average was 0.5 m/s or more above current MacCready setting. Blue colour means that the thermal average was 0.5 m/s or less below current MacCready setting. Yellow colour represents matching thermal average.

On the left side an altitude scale is drawn. On the right-hand side a big numerical value shows the average thermal vario of last 4 passed thermals. Number of thermals that are averaged can be adjusted under Setup->Graphic->Misc.

The shape of the thermal column corresponds to the thermal strength at a particular altitude.

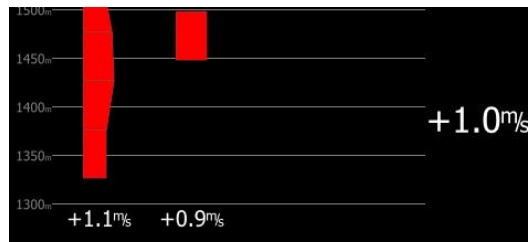

6.3.26 Meteogram

This is a graphical representation of a weather forecast from the selected APT with valid ICAO sign (if available).

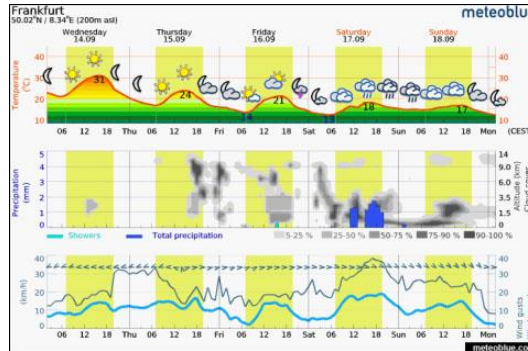

6.3.27 SC Vario

SC Vario is an indication of the vario mode (speed command or vario mode).



6.3.28 FLARM

Shows the FLARM indicator on the navigation page.

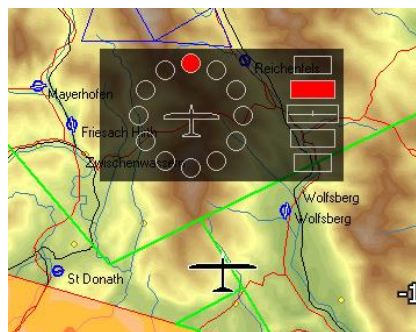

5 vertical squared LEDs are describing vertical angle of threat divided by 14°.

6.4 Navigational Page Settings

Press the SETTINGS option to open the dialogue for page global styles.

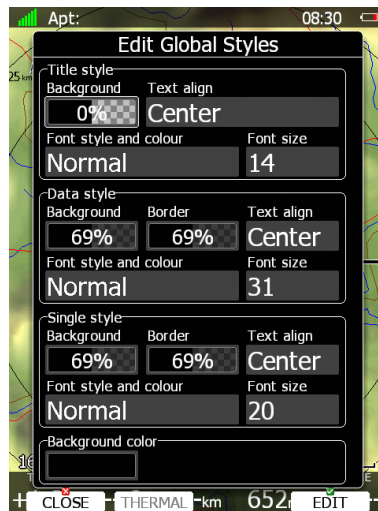

The dialogue is split into four groups. The first group defines colours and font properties for the title of the navbox. The second group defines colours and font properties for the navbox main value. The third group defines properties of navboxes, which have only a single line. In last group background for the navigational page is defined.

You can set the current page in mode as a thermal page by pressing the **THERMAL** button. The button will become disabled which means that current page is already a thermal page.

7 Glider setup

In the following chapter and example how to enter weight and balance parameters are entered for a glider Arcus M. Data is taken from Maintenance manual for powered sailplane model Arcus M, edition October 2012 and from a Weight and Balance report for a selected Arcus M.

Create a new glider in the Glider and Polar dialog. Select Arcus M from a list of predefined gliders. Polar dialog will look like the one below and weight and balance will be empty.

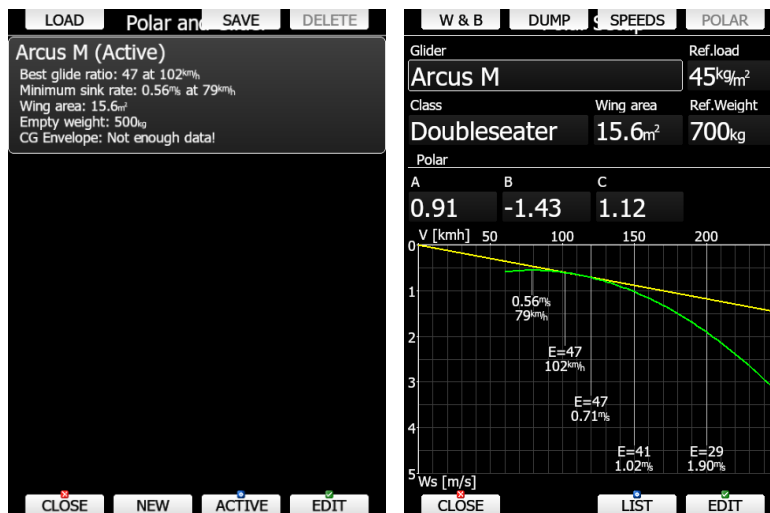

First, we will enter weight and balance parameters and define CG envelope.

7.1 Weight and balance parameters

7.1.1 Weights and arms

Empty weight and balance shall be entered first. Values should be obtained from latest weight and balance report as shown on picture below.



If you are not interested in CG of your glider, you can only set up ballast and ignore the accuracy of the arm length values. In this case you must ignore the proposed CG values as they are not accurate.

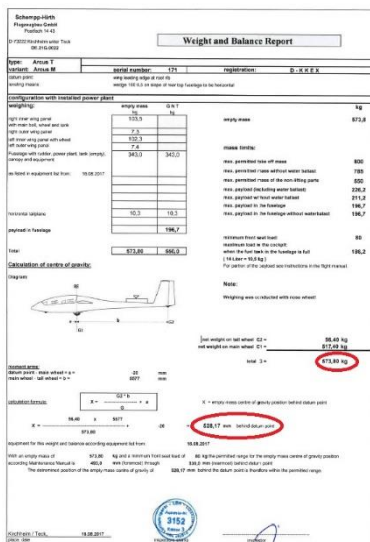

Enter 574kg and 528mm as parameters for mass and arm into the dialog. Once you finished this, select other parameters from tabel in Arcus M maintenance manual.

6.6 Payload (continued)

For establishing a „Weight & Balance Report“ the following lever arms are to be used:

	Center of gravity in relation to datum
Trim ballast under front instrument panel	2153 mm forward of datum 84.76 in.
Trim ballast on right hand side of front control stick mounting frame	1953 mm forward of datum 76.89 in.
Pilot, front seat (with parachute or back cushion)	1468 mm forward of datum 57.80 in.
Engine battery at steel tube transverse frame	978 mm forward of datum 38.50 in.
Battery at rear control stick mounting frame	708 mm forward of datum 27.87 in.
Pilot, rear seat (with parachute or back cushion)	308 mm forward of datum 12.13 in.
Main wheel	20 mm forward of datum 0.79 in
Water ballast, wings	17 mm forward of datum 0.67 in.
Wing fuel tank	145 mm aft of datum 5.7 in
Fuel tank in the fuselage	492 mm aft of datum 19.37 in.
Power plant, retracted (engine with propeller, muffler, spindle drive)	1170 mm aft of datum 46.06 in.
Fixed tail wheel / skid	5302 mm aft of datum 208.74 in.
Steerable tail wheel	5557 mm aft of datum 218.78 in.
Battery fin	5277mm aft of datum 207.76 in.
Water ballast, fin	5292 mm aft of datum 208.35 in.

October 2012
Revision --

Following values are entered into the dialog.

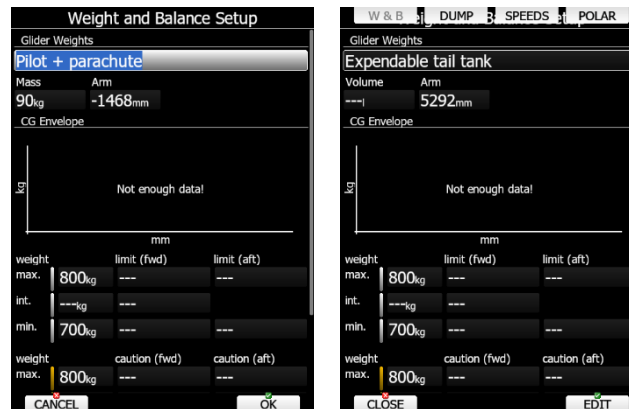

For Pilot + parachute arm is -1468mm. Copilot + parachute arm is -308mm, water ballast main -17mm, expendable tail tank 5292mm. As a fuel tank aux a wing tank is selected and arm of 145mm, main fuel tank 492mm. As a user defined value, we have selected fin battery, however you can select and other value.

Pilot and Copilot weight are not necessary to enter at this point as you can enter it later via Weight and Balance pilot dialog or Flight recorder dialog.



Auxiliary fuel tank is always drained before main fuel tank.

For water ballast logic is different, first fin tanks are dumped and then main

tanks, when using dump switch or DUMP option. You can check the **Fill/dump main tank first** option to inverse this.

7.1.2 CG envelope

To enter CG envelope, we will need a mass-c/g diagram as defined in maintenance manual for Arcus M.

6.7 Mass – c/g diagram (powerplant installed)

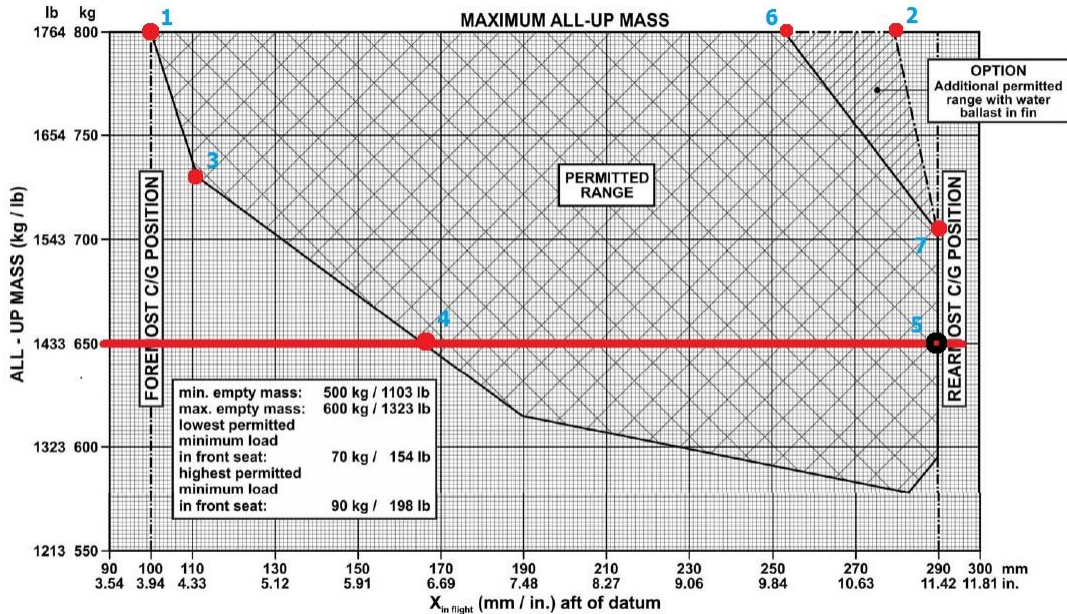

October 2012
Revision --

6.7.1

First, we will enter data for maximum weight, which is 800kg. Point 1 shall be entered as forward limit for max. weight and point 2 on picture above should be enter as aft limit for max weight. Next, we enter point 3 as intermediate forward limit. As empty weight of our glider is 573kg and minimum cockpit load on front seat is 80kg, it makes no sense to enter values for minimum weight below 653kg. Enter 650kg as minimum weight and point 4 and 5 for forward and aft limit, respectively. An CG envelope should look like one the picture below on the left side.

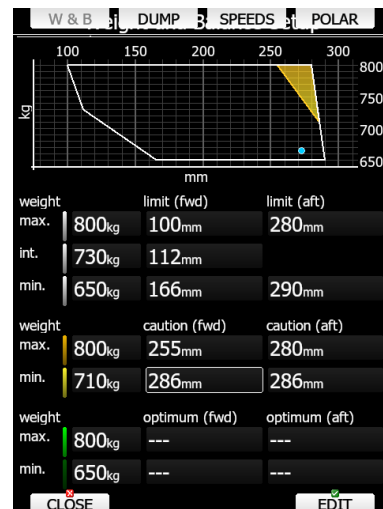

We can continue entering points for caution zone. For maximum weight enter point 6 as forward limit and point 2 again as aft limit. As caution zone is having triangular shape.

Point 7 is entered twice for minimum weight. CG envelope will look like one on the picture above to the right.

If you wish, you can also enter optimal range, which is not specified for Arcus M glider.

7.2 Glider speeds

Glider speed should be read from flight manual or from place cards inside the glider. It is crucial that flaps speed is recalculated for a reference weight.

Use of flaps for	flaps at	OPTIMUM AIRSPEED in km/h	
		AUW = 625 kg	AUW = 800 kg
Low speed flight	L	- 83 km/h	- 94 km/h
	+2	83 - 90 km/h	94 - 100 km/h
	+1	90 - 105 km/h	100 - 120 km/h
Best L/D	0	105 - 130 km/h	120 - 150 km/h
Flying between thermals and high speed flying	-1	130 - 155 km/h	150 - 180 km/h
	-2	155 - 175 km/h	180 - 195 km/h
	S	175 - 280 km/h	195 - 280 km/h

In our case, we have to recalculate flaps to reference weight of 700kg. This can be done with linear interpolation between values for 625kg and values for 800kg. Interpolated values are as follows:

- L - 88kph
- +2 88kph - 94kph
- +1 94kph - 111kph
- 0 111kph - 139kph
- 1 139kph - 166kph
- 2 166kph - 184kph
- S 184kph - 280kph

Once you have entered these values in speed dialog, it should look like one below.

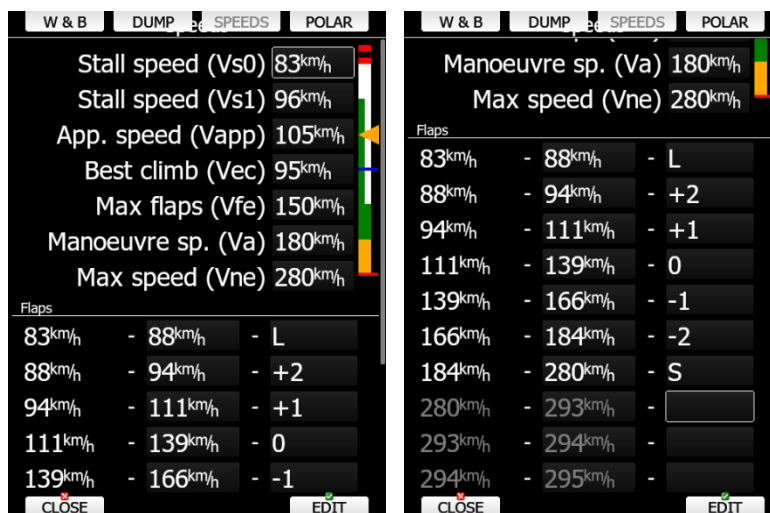

7.3 Glider dump rates

In this dialog you may define dump rates for water ballast and fuel. Once dump rates are defined, device will automatically calculate remaining fuel, when engine will be running. Remaining water will be calculated once DUMP button is pressed or if water switch is connected to the system.

For Arcus M main tank capacity is 14 litres, fuel consumption is around 25l/h. Dump rates for water as stated in flight manual for Arcus M is 3.5minutes for full tanks, which give a rate around 60l/minute. For more precise calculation measurement must be done. Enter these values in the menu and you are ready to go.

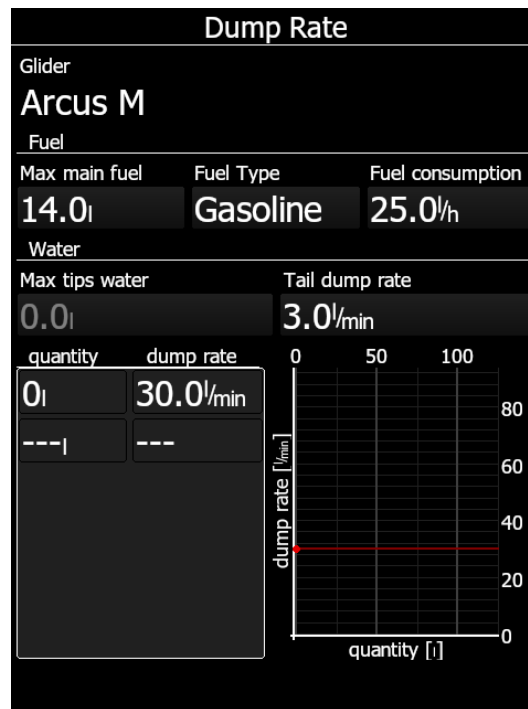

If you try to land without dumping all of the water ballast, you will see a repeating warning "Check ballast". This is triggered when you lower landing gear (if the input switch is installed) or when your IAS is below 50 m/s while being low near landable/flat terrain.

8 HAWK

8.1 Introduction

HAWK system was developed by Prof. Heinrich Meyr* and Peng Huang** in cooperation with LXNAV. It features a completely new approach towards measuring the three-dimensional wind vector.

A conventional vario measures the vertical movement of the glider (vario) based on an energy conservation principle. This value can be assigned to the red needle of the LX instrument. In perfectly smooth air, the change of the vertical kinetic energy (velocity) is compensated by an equal amount of potential energy (altitude). A total energy compensated (TEK) vario works well under the condition of constant horizontal velocity. However, any change of the horizontal velocity (horizontal wind gust) is interpreted by the TEK vario as a change of the vertical velocity (kinetic energy), thus causing the well-known false reading of the TEK vario.

The HAWK does not measure the vertical movement of the glider. It measures the air mass movement in three dimensions. The climb rate of the glider ("HAWK vario") is derived by subtracting the ideal sink rate given by the circle polar from the vertical climb rate of the air mass. It is, therefore, crucial to understand that the "HAWK vario" shows the potential climb rate of the glider. This is the climb rate of the glider achievable under ideal conditions. "HAWK vario" value is shown by the blue needle of the instrument in thermaling mode.

If the pilot uses the two-needle approach the red and the blue needle are normally close. If they differ substantially, it hints that the pilot flies with a large sideslip angle causing additional drag and sink. Changing the yaw string pointing slightly outside makes the red approach the blue needle: the real climb rate approaches the potential climb rate. This will be discussed in detail in section 8.3 and 8.4.

In cruise mode, the blue HAWK needle should be assigned to "netto" or "relative". At all speed the HAWK needle then shows the climb rate of the air mass ("netto"). If "relative" is assigned to the needle, it shows the minimum sink rate subtracted from the "netto".

The horizontal dimensions of the air mass movement show the wind. The wind is live wind. In mountain flying it is of crucial importance to have the wind indication following the rapid changes of the wind in real time. Today's wind estimation algorithms deliver only mean values with average times in the range of minutes.

The unique differentiator of HAWK is

- It delivers the horizontal wind and the vertical air mass movement (vario) in real time
- No false climb indication due to horizontal gusts in fast cruise mode. If HAWK signals show a thermal there is a thermal with high probability
- A few seconds earlier indication when approaching a thermal than the TEK vario
- No false reading due to horizontal gusts in turbulent thermals
- No compensation required

*RWTH Aachen University and Barkhausen Institut, Dresden, Germany.

**Vodafone Chair Mobile Communications Systems, Technische Universität Dresden, Germany.



HAWK is suitable only for VFR flying

8.2 Wind Model

The HAWK requires a mathematical model of the three-dimensional wind vector. Figure below shows wind field estimated by HAWK. The wind vector $\mathbf{d}(x, y, z; t)$ depends on the three

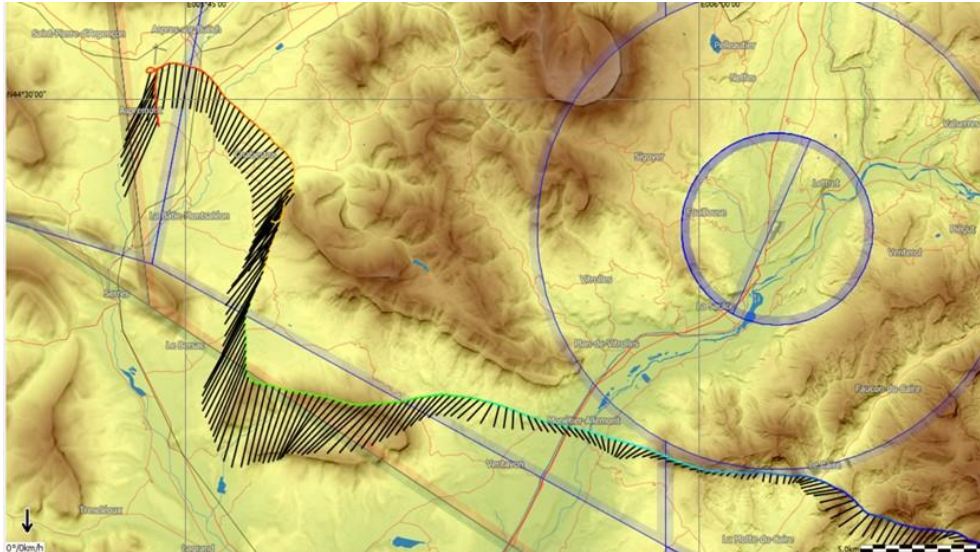

Wind field estimated by HAWK.

spatial coordinates (x, y, z) and the time t . The wind field is described by very complex mathematical equations. For our purposes, it is sufficient to use a greatly simplified model. We assume that the wind vector comprises two elements: a slowly varying component and a rapidly varying random disturbance. Next figure shows that the more turbulent the air mass, the larger the random increment is. The three wind components are assumed to be independent of each other. All three obey the same mathematical law.

The perspective representation of a three-dimensional vector on the display does not make sense for gliders. Glider pilots are used to reading the vertical component of the vector on the Vario and interpreting the x-y components as "wind".

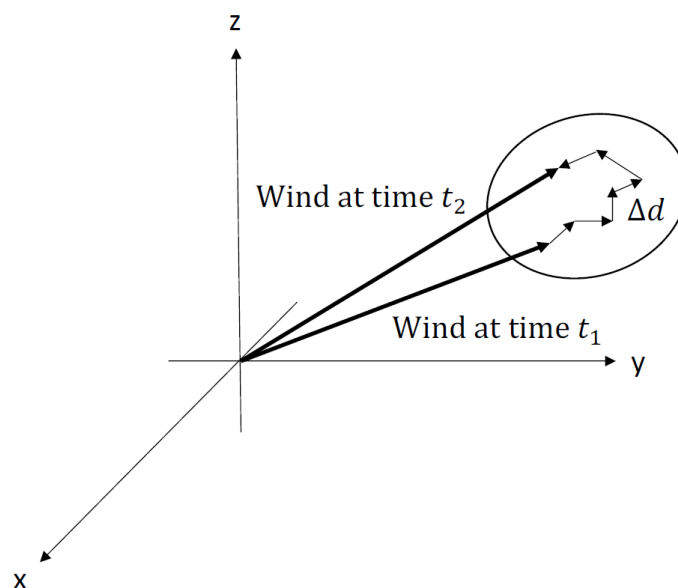

Time behaviour of the wind field $\mathbf{d}(x, y, z; t)$.

For an intuitive understanding of the model, we limit ourselves to the vertical component. We are used to interpreting the rate of the variometer by the movements of the pointer. For this reason, we look at the increment over a time interval of 1 second.

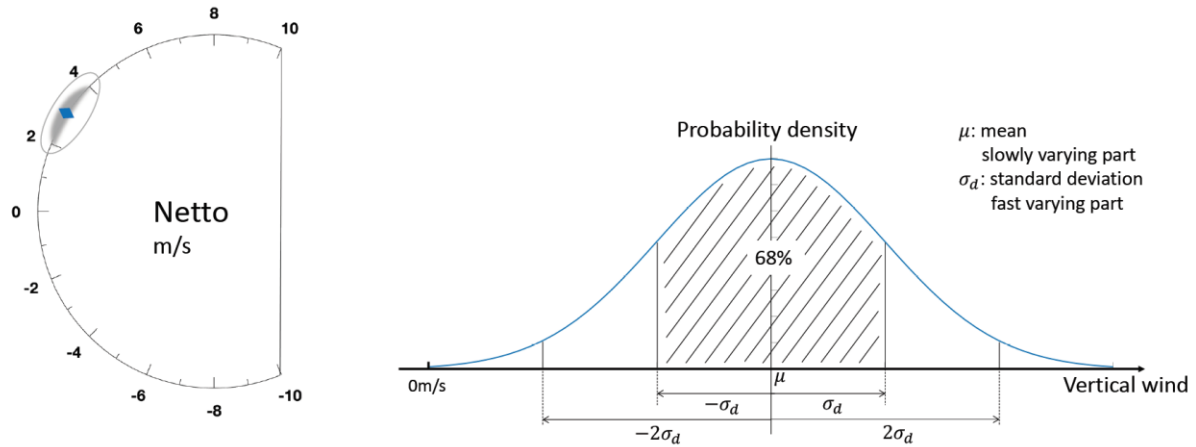

In picture above, the variometer shows a value of 3m/s. This value corresponds to the slowly changing part of the model. The rapidly changing, random part corresponds to the fluctuations of the pointer around the mean. The pointer fluctuations are Gauss- distributed, see right picture above. The Standard Deviation parameter, σ_d determines how likely an increment is around the mean of 3 m/s. For example, $\sigma_d = 1$ m/s states that 68% of all changes are in an interval of 1 m/s. The value $\sigma_d = 0.1$ corresponds to a very quiet air mass. Most changes will be at an interval of 0.1 m/s.

The true model parameter σ_d is of course unknown to the instrument. The key question is, therefore, how do we select the corresponding parameter in the S10/100?

The only way to do this is to use the same data sensor signals for different values of wind variance and study the behaviour of the vario. We can do this because we record all sensor signals at 100Hz using the special logging function in S10/100.

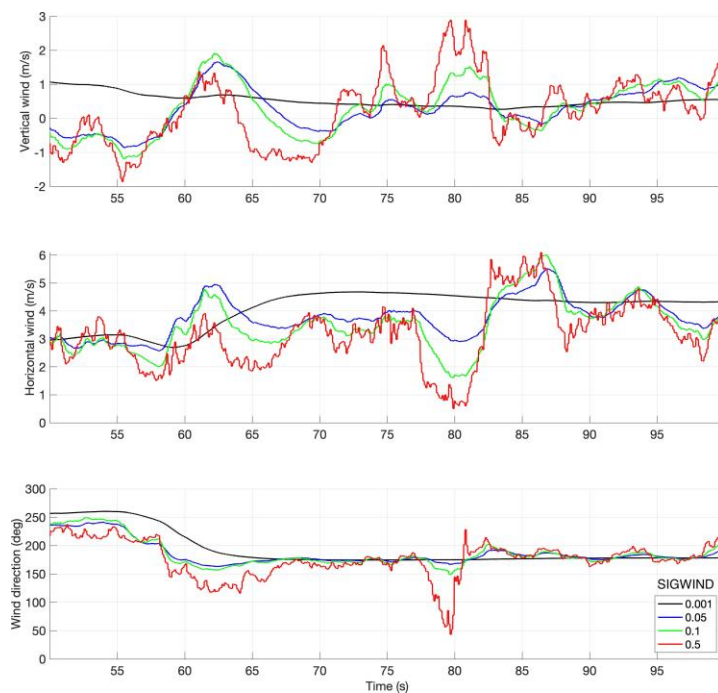

Behaviour of the air mass movement for various values of wind variance = (0.001, 0.05, 0.1, 0.5) in a typical flight.

Let us choose a value wind variance = 0.1, which looks plausible. Qualitatively, if we select a very small value of wind variance = 0.001 the algorithm will average the estimate since it considers large deviations Δd as highly unlikely and suppresses them. We next consider the opposite case and select a much larger value wind variance = 0.5. The algorithm reacts quickly to any disturbance. We will observe a nervous reading of the needle in the instrument. Picture above shows a segment of a typical flight.

We observe that the most likely values are around wind variance = 0.1. For wind variance = 0.5 the random fluctuations are larger. The values smaller than 0.05 are too small since they suppress important details of the time behaviour. It appears that the values in the interval of 0.05-0.2 are the preferred ones. But this is a qualitative and subjective observation not based on a rigorous mathematical optimization.

In summary, the selection of the wind parameter, Wind variance, is not very sensitive. It leaves room for personal preferences of the pilot, as vario needle filter for the TEK vario. During tests most pilots have chosen a value between 0.05-0.2.

8.3 The potential climb rate

The "HAWK vario" is a derived quantity from the primary information of the algorithm. It is computed by subtracting the ideal circular polar sink rate from the estimated vertical air mass movement ("netto"). The "HAWK vario" equals the **potential climb rate** of the glider. By this we understand the maximum achievable climb rate of the glider.

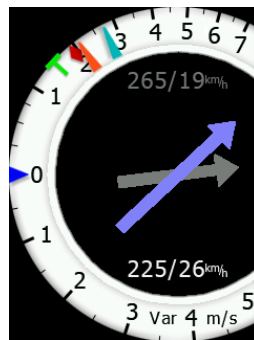

The two-needle approach helps to optimize the thermaling performance by comparing the real climb rate of the red needle ("TEK vario") to the potential climb rate of the blue needle ("Hawk vario"). For example, if the pilot flies with a large sideslip angle, the difference between the two needles can be minimized by flying with a smaller sideslip angle. The red needle will approach the blue needle: the real climb rate has become larger.



Having HAWK active and working in the front seat device will automatically also allow the repeater unit to utilize all the functionalities and functions of the HAWK. This also applies to the two needles on the second seat vario indicator.

8.4 The Aerodynamic Model

The HAWK uses the polar diagram of the glider and a sideslip coefficient to compute error signals. The sideslip coefficient is calculated from the aerodynamic properties of the glider. These parameters are internal variables of the HAWK and cannot be modified by the user.

The sideslip angle has a strong impact on the performance of the glider. The string is a simple but key instrument for the pilot to keep the sideslip small. A sideslip causes an additional drag which is particularly annoying during circling since it largely increases the

sink rate. The increase of the sink rate is reinforced when the pilot flies with a large roll angle (circle polar).

During circling most pilots fly with the string slightly outside. The HAWK calculates the sideslip angle. The large majority of pilots fly with small sideslip angles of less than 4 degrees.

Before we demonstrate the effect by an example, we recall some properties of the conventional TEK vario. Assuming a smooth thermal, the TEK vario measures the actual climb rate of the glider, not the air mass movement. If we fly with a large side slip, the glider's climb rate is smaller than flying with zero sideslip in the same thermal. The Netto TEK and the Relative TEK vario are derived quantities by adding fixed constants to Vario TEK. These constants are calculated from the polar diagram in still air.

The HAWK operates entirely differently: it estimates the climb rate of the air mass (Netto HAWK) from the vertical wind triangle. The sum of vertical wind (climb rate of the air mass) and vertical true airspeed (sink rate) equals the vertical "ground" speed (actual climb rate of the glider). The vertical ground speed is the actual climb rate of the glider. More details can be found in the paper of the Segelfliegen Magazin "Wissen, woher der Wind weht" which can be downloaded from our webpage.

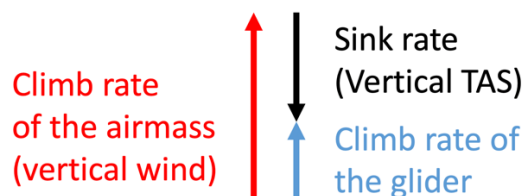
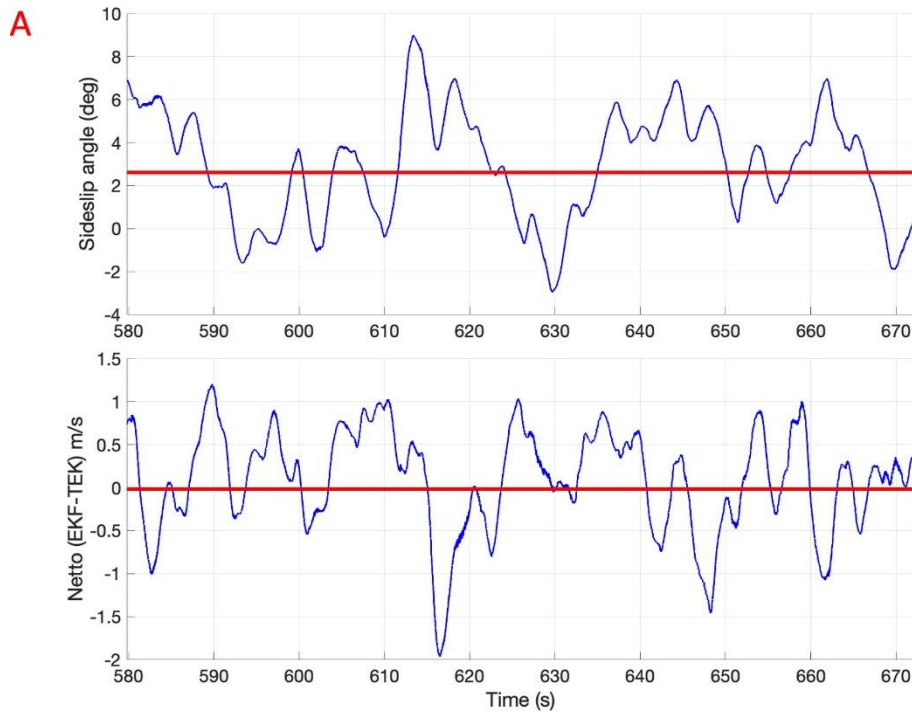

Fig Vertical wind triangle

An example greatly helps to illustrate the details. The table below summarizes the velocities during three circling segments of the same flight by an ASG 32. The segment A has been taken during right circling with a roll angle of about 40 degrees. In the picture on the next page the average sideslip angle is around 2.7 degrees. The glider climbs with 1.4 m/s (2nd row in Table). The Netto HAWK equals 2.7 m/s. The sink rate HAWK is estimated as -1.0 m/s. According to the vertical wind triangle, the summation of the Netto HAWK and the sink rate HAWK equals 1.7 m/s. Due to the short-term averaging, the difference is not exactly 1.4 m/s as the actual climb rate. We next compare this to the readings of the TEK vario. The average Netto values of TEK and HAWK over the segment A are the same. In the 6th row we show the sink rate computed from the circle polar using the roll angle computed in the artificial horizon of the HAWK.

Average	A (580 - 670s)	B (2033 - 2106s)	C (2106 - 2194s)
Sideslip angle	2.7 deg	-12 deg	-6.2 deg
Climb rate of glider	1.4m/s	1.8 m/s	2.1 m/s
Netto (HAWK)	2.7 m/s	4.4 m/s	4.5 m/s
Sink rate (HAWK)	-1.0 m/s	-2.9 m/s	-2.4 m/s
Netto (TEK)	2.7 m/s	2.6 m/s	3.2 m/s
Sink rate (circle polar)	-1.0 m/s	-1.1 m/s	-1.3 m/s
Netto HAWK – Netto TEK	0 m/s	1.8 m/s	1.3m/s
Vario (HAWK)	1.7 m/s	3.3 m/s	3.2 m/s
Vario (TEK)	1.8 m/s	1.9 m/s	2.4 m/s



Segment A: Sideslip angle and Netto difference.

In a nutshell: The agreement between TEK and HAWK vario during stationary circling of the glider is particularly good. This changes completely when we analyse segment B and C. Picture below shows two segments B and C of the same flight of the ASG 32. They are taken during left circling with a roll angle of 45 degrees. In segment B the sideslip angle has been intentionally increased by the pilot to a large value of -12 degrees.

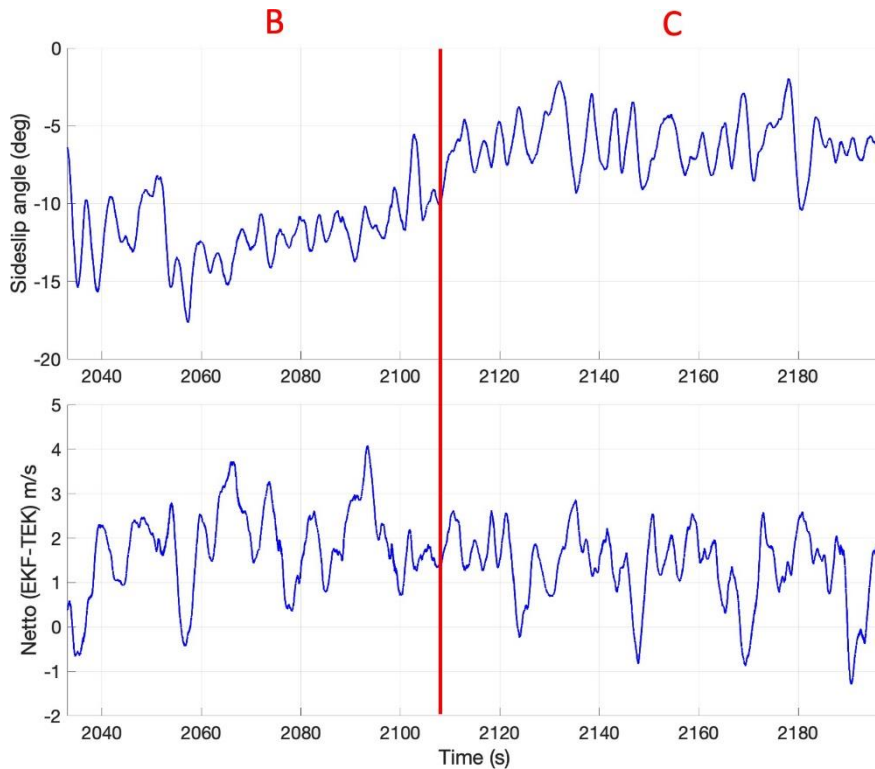

Segment B and C: Sideslip angle and Netto difference.

In segment C the sideslip angle is decreased to -6.2 degrees. The string is slightly pointing outside, as usual.

We first analyse segment B where the sideslip angle is -12 degrees. The glider climbs with 1.8 m/s (2nd row in Table 1). The vertical wind (Netto HAWK) equals 4.4 m/s. The Vertical TAS (sink rate) is estimated as -2.9m/s. Based on the vertical wind triangle, the summation of these two values equals 1.5 m/s. Due to the short-term averaging the difference is not exactly the climb rate 1.8 m/s. We next compare the Netto HAWK to the readings of the TEK vario. The most striking result is that the Netto values of TEK and HAWK differ by 1.8 m/s because the glider suffers from a large sink rate due to the large sideslip. The Netto TEK is derived by adding a fixed constant to Vario TEK. This constant does not consider the impact of circling and sideslip.

We next analyse segment C. The glider climbs with 2.1 m/s faster than in the segment B. This is expected due to a smaller sink rate in a smaller sideslip. The sink rate HAWK is decreased to -2.4 m/s. The Netto TEK increases from 2.6 m/s (B) to 3.2 m/s (C). This increment is due to less drag in the segment C. There is still a large difference of 1.3 m/s (C) between the Netto values of TEK and the HAWK, but the difference is less than in the segment B. The sink rate of the HAWK decreases from 2.9 m/s to 2.4 m/s. The difference between the sink rate HAWK and the circle polar sink rate is 1.1 m/s. It equals the loss of the climbing rate due to a sideslip caused drag.

In a few cases it has been reported that the average HAWK vario in weak thermal shows too large climb rates of up to 0.5 m/s. The analysis of the recorded flight data in the lab showed that the sink rate was larger than the theoretical value computed by the circular polar. The side slip angle was small. The difference could therefore not be attributed to the side slip angle. The additional drag can be caused by a number of reasons. A single cause-effect logical chain could not be identified. Possible reasons are wrong polar and glider data, malfunctioning of the pressure system, inaccurate time mismatched static and total pressure signals etc.

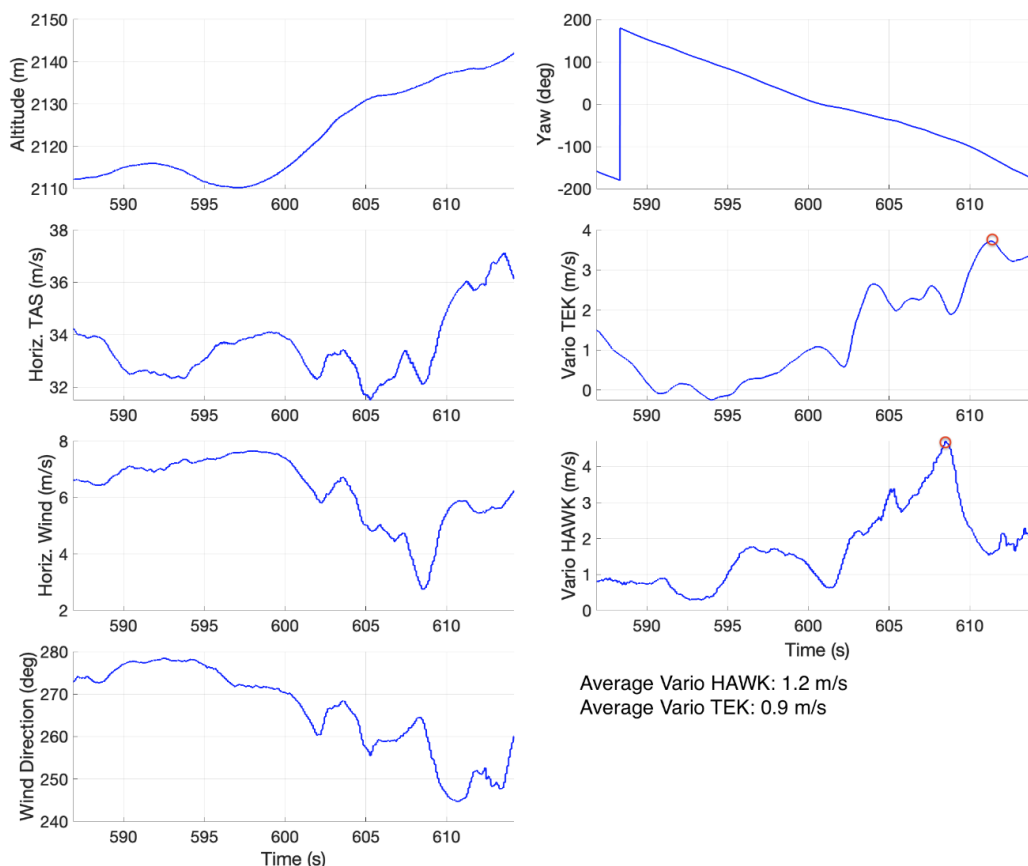

TEK and HAWK vario during one circle

8.5 Dynamic behaviour

Dynamic behaviour of the TEK vario and the HAWK vario is different. The vario HAWK and TEK are shown in the first figure above. The average climb rate of the two varios is shown in the bottom right. They are comparable taking into account the short averaging interval. As expected, the behaviour as a function of time is markedly different. The signal of the TEK vario depends on the averaging time constant chosen by the pilot and on the false signals caused by horizontal gusts. The HAWK vario signal depends on the wind parameter SIGWIND and internal parameters. The resemblance of the vario signals increases in smooth thermals.

Thermal assistant: It is obvious that the thermal assistant shows a different pattern. Note that the maximum of the HAWK vario in the above example occurs 4 sec earlier.

8.6 HAWK system activation

In order to run HAWK system, a HAWK option must be purchased. Please contact your local dealer or LXNAV directly to get your HAWK option. Once you receive option file from us refer to Chapter 12.2 for installation procedure.



HAWK system can also be tested free of charge for a period of 3 months. Please visit www.lxnav.com to obtain you demo option for HAWK system.

8.7 Setup parameters

8.7.1 Netto Vario

The HAWK estimates the vertical air mass movement. For a conventional TEK variometer the term "Netto" is understood as the vertical air mass movement. However, the TEK variometer only approximates the vertical air mass movement by adding the sink rate to the measured TEK Vario value. But for practical purposes, the difference between the "Netto" and the real vertical air mass movement is small. For this reason, we also use the term "Netto" for HAWK.

8.7.2 Vario

For the compensated TEK variometer the (primary) output TEK Vario is the actual climb/sink rate of the glider. The HAWK computes the value by subtracting from the vertical component of the air mass movement "Netto" the polar sink rate (TAS, roll angle). Notice that the sink rate is computed using the estimated roll angle in the circle polar computation.

8.7.3 Relative Vario (Super netto)

In the speed to fly mode the pilot wants to know the potential climb rate of a thermal. This value is the vertical climb rate "Netto" of the HAWK. If one subtracts from "Netto" the constant minimum sink rate this is the "Relative" output.

For the TEK Variometer the "Relative" must be computed from the primary source TEK Vario by adding the current sink rate minus the minimum sink rate. All computations are summarized in the following table.

	Classical vario calculation	HAWK calculation
Netto	TEK_Vario+sink_rate(IAS,roll_angle)	Netto
Relative (Super netto)	TEK_Vario+sink_rate(IAS,roll_angle)-min_sink_rate	Netto-min_sink_rate
Vario	TEK Vario	Netto-sink_rate(IAS,roll_angle)

8.7.4 Levelling AHRS



It is absolutely necessary that the plane is aligned with the longitudinal axis defined in the manual of the glider. Any misalignment leads to systematic errors in the HAWK algorithm.



HAWK algorithm can compensate $\pm 10^\circ$ of the pitch offset. If the unit is installed in the glider with more offset, HAWK algorithm might not work properly.

If installed device is not perfectly aligned with glider longitudinal axis it is essential to do a pitch alignment, which can be done in Setup>Hardware>AHRS menu. Put glider into zero degrees pitch position, usually this is a weighting position and press Level button in this menu. Device will perform auto-levelling procedure and system pitch offset will be calculated. See also chapter 5.1.12.10 for more details.

8.7.5 HAWK Parameters

HAWK parameters can be setup in via Setup>Vario Parameters menu. See chapter 5.1.4 for details. Following parameters can be set there:

- Wind variance SIGWIND: range 0.005 to 0.5 (recommended value: 0.11).
- Horizontal wind average: range 0.1 to 100sec (recommended value: 30sec).
- Vertical wind average: range 0.1 to 50 sec (recommended value: 10sec).

8.7.6 Graphical display

It is recommended to set following display options, when using HAWK system.

In Setup>Graphics>Indicator set both needles to be visible. Set blue needle for HAWK values and red needle for TEK values. Set vario needle type to vario or relative and SC needle type to netto or relative.

See chapter 5.1.12.4 for details.

8.7.7 Audio source

When HAWK option is activated, audio source can be chosen between HAWK or TE vario. See chapter 5.1.8.1 for more details.

8.8 Restarting HAWK

8.8.1 Manual restarting

HAWK can be restarted at any time. To ease restarting the procedure must be quick and simple. For this reason three restarting methods have been introduced in the top hierarchic level, see the screenshots below.

A long pressing of the bottom-left button HAWK restarts from any page at any time. Restarting takes only one sec. The message "HAWK is restarting!" is displayed.

The other two restarting buttons are accessible from the Vario parameter page and the MacCready setting page.

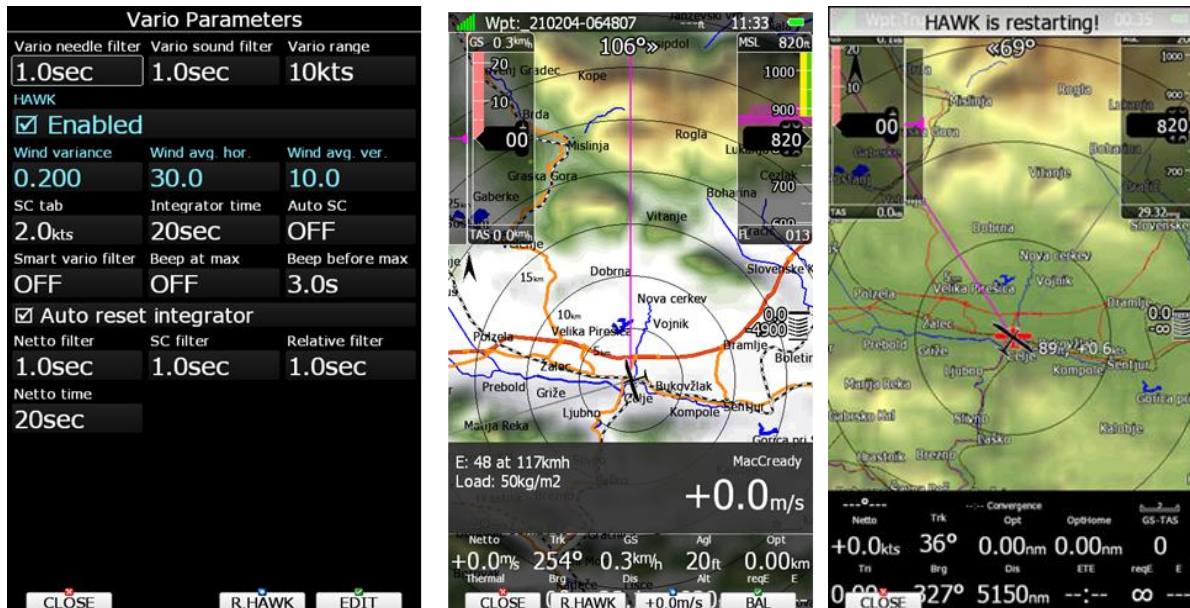

8.8.2 Automatic restarting: The "HAWK Watchdog"

An algorithm called HAWK Watchdog has been developed. The algorithm analyzes the received signals and rejects the outlier. It processes the plausible values in a modified algorithm without restricting the functionality.

However, if the rate of outliers exceeds a given threshold, the watchdog signals to the pilot »AHRS only!«. When the outlier rate decreases below the threshold hawk automatically restarts, displaying the message »HAWK is restarting!«.



Automatic restart is done only few times during flight. However manual restart is always possible.

9 Flying With the System

To get the best out of the system it is important that some preparation is done prior to take-off. Trying to configure the instrument or set a task while flying is very hazardous especially in a competition. At least, it could spoil your whole day! Pre-flight preparation will ensure that the flight will be both safe and enjoyable.

9.1 On the Ground

9.1.1 Power-On Procedure

Press the power-on button. The main display unit and the vario unit will turn on and a few moments later welcome screen will appear. The first screen shows the version of the boot loader followed by the version of the Linux kernel operating system, then the version of the file system. The boot procedure normally takes 10 seconds. When completed the profile selection dialogue is shown.



It is recommended to switch the unit ON some minutes prior to take-off to give the GPS receiver time enough to acquire satellites. The flight recorder will also make a take-off baseline. Longer running on the ground will not reduce flight recorder capacity.

9.1.2 Profile Selection



Turn the PAGE selector knob to select the desired profile if more than one profile is available. First profiles stored in internal storage are displayed, then profiles on SD card are shown and finally profiles on a USB stick are shown. You will note that a profile resides on the SD card/USB stick by a small SD card/USB stick symbol in the lower-right part of the pilot icon.

For the selected profile the pilot name, loaded waypoint files, loaded airports databases and loaded airspace databases are shown.

If a file is stored on a SD card or USB stick, a label [SD] or [USB] will appear in front of file name.

To learn more about profiles refer to Chapter 5.1.14. Press the **SELECT** button to confirm selection of the profile. Press the **DEFAULT** button to start the system with default settings. The set elevation dialogue will follow.

9.1.3 Set Elevation and QNH

This setting is crucial for final glide calculation: therefore, pay careful attention to it.



The instrument will offer a value for elevation from the terrain database based on the current latitude and longitude. Elevation will mostly be within few meters from the current elevation. Use the PAGE selector knob to fine-tune the elevation. If the elevation is unknown and the QNH pressure is known you should NOT press button **QNH**. Just keep turning the PAGE selector knob and observe the QNH value to adjust it to the proper value. The **QNH** button should be pressed only when airfield elevation and QNH pressure are given. This might happen on some competitions. In all other cases elevation should always match QNH pressure.



The Profile selection and Elevation dialogues are not shown if the system is switched off and on during flying.

9.1.4 Pre-flight Check

After elevation setup the system will switch to airport mode. It will take a few moments to draw the map screen for the first time. All waypoint files and databases are loaded at that time and therefore instrument might react somewhat slowly.

9.1.4.1 MacCready, Ballast, Bugs

It is recommended to check the MacCready, ballast and bugs settings to match the current glider configuration. Press the **MC/BAL** button. The dialogue for MacCready, Ballast and bugs will appear.

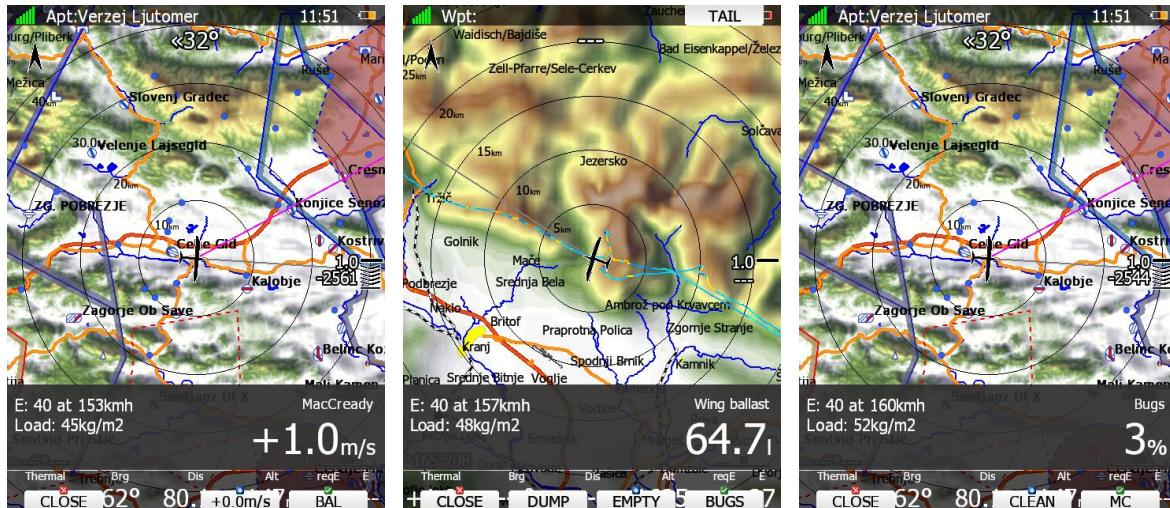

Use the PAGE selector knob to modify the MacCready setting. Refer to Chapter 6.2.1.1 for more details.

It is also highly recommended to check the safety altitude setting. Refer to Chapter 5.1.1 to find out how to define the safety altitude.

9.1.5 Preparing a Task

While it is advisable to prepare the task properly before taking off and thus avoid mistakes made in a haste, actions such as preparing, editing, loading and saving can be done while in the air. However, the task cannot be declared in the air.



There is only one task which can be declared. This task will be automatically declared in the IGC file on take-off. The task can also be modified during flight but any changes will not be written to the IGC file.

There are currently three methods to create a task.

- Read a waypoint and task file from SD card and load a saved task.
- Load a similar task and modify it.
- Enter a task manually.



It is very important to check the task prior to take-off. Check the turning points sequence, distance between points, bearings and total task distance. Visually check the task and observation zone geometry in the map view.

9.1.5.1 Assigned Area Tasks (AAT)

In fact, an assigned area task is a speed task where the task distance is not exactly defined. The pilot has limited influence on the task geometry due to larger observation zones (assigned areas). The pilot decides how far he will fly into each individual area to reach best average task speed whilst not finishing the task earlier than the designated task time.

An assigned area task has the same structure as other tasks and all known methods to enter are the same as described. The only differences are larger observation zones having a specific geometry. Use the **ZONE** button (see Chapter 5.7.2.3) to modify the individual observation zone.

It is also recommended to use the AAT assistant tools such as optimal track and AAT isolines. Optimization is only shown for currently selected assigned area.

When **Show optimal track** is enabled a small blue arrow is drawn next to the aircraft. This arrow indicates most optimal direction to fly.

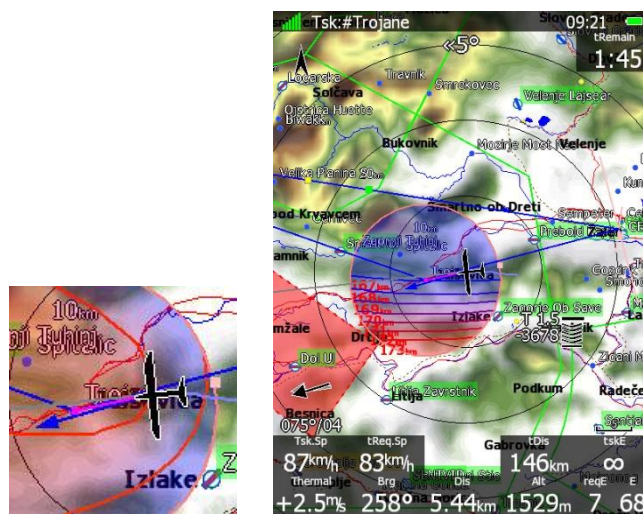

19.07.2007

Type: Assigned area task with 4 areas

Task time: 02:30:00

Task distance: 163,5km/344,4km

Style	Code	Points	Latitude	Longitude	Dis.	Crs.
Take off		000SZEGE	N46,247500°	E020,091383°		
Start		004DOMAS	N46,252500°	E020,026950°		
1.Point		115MELYK	N46,213050°	E019,371383°	50,6km	265°
2.Point		088KISKO	N46,626383°	E019,299450°	46,3km	353°
3.Point		167SZEKU	N46,504167°	E020,542500°	96,0km	98°
4.Point		006SZATY	N46,329450°	E020,053617°	42,2km	243°
Finish		001SZEGE	N46,252783°	E020,090833°	9,0km	161°
Landing		000SZEGE	N46,247500°	E020,091383°		

Observation zone description:

Start 004DOMAS: To Next Point, Line 6,0km

[Style=To Next Point, A12=Auto, R1=3,0km, A1=45°, R2=0,0km, A2=0°, LineOnly]

1.Point 115MELYK: Cylinder R=20,0km

[Style=Symmetrical, A12=Auto, R1=20,0km, A1=180°, R2=0,0km, A2=0°, Assigned area]

2.Point 088KISKO: R=20,0km, Brg1=150°, Brg2=270°

[Style=Fixed Value, A12=30,1° R1=20,0km, A1=120°, R2=0,0km, A2=0°, Assigned area]

3.Point 167SZEKU: Rmin=10,0km, Rmax=20,0km, Brg1=100°, Brg2=180°, Cylinder R=10,0km

[Style=Fixed Value, A12=320° R1=20,0km, A1=140°, R2=10,0km, A2=180°, Assigned area]

4.Point 006SZATY: Cylinder R=500m

[Style=Symmetrical, A12=Auto, R1=0,5km, A1=180°, R2=0,0km, A2=0°, Assigned area]

Finish 001SZEGE: To Previous Point, Line 1000m

[Style=To Previous Point, A12=Auto, R1=0,5km, A1=45°, R2=0,0km, A2=0°, LineOnly]

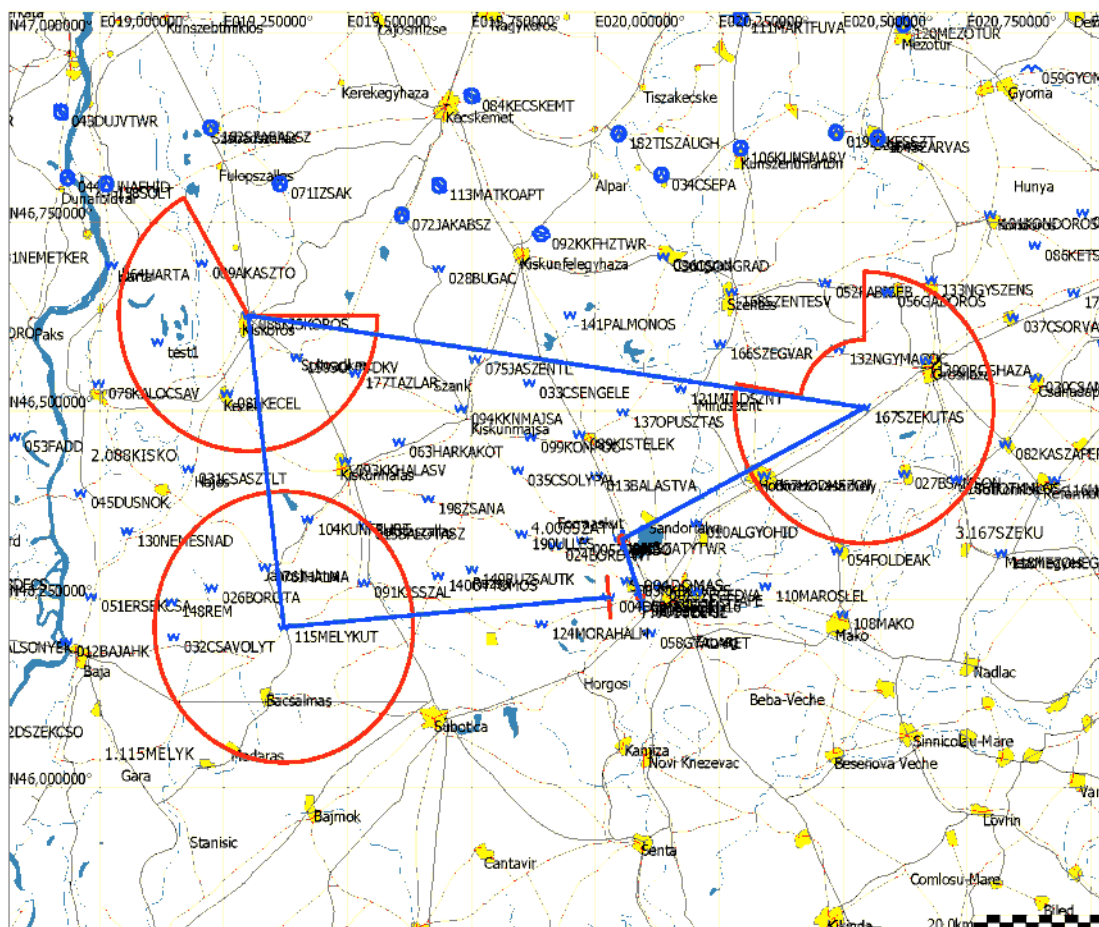

Usually a task sheet with observation zone definitions matching the system observation zone definition will be given. An example of a task sheet is shown above. However, when an

assigned area is defined only with two radials and two radii some calculation must be accomplished.

Let us assume an assigned area defined as:

Radial1=30°, Radial2=70°, Min.radius=50 km and Max.radius=200 km

To convert this description the following calculation must be performed:

- Direction set to FIXED.
- $\text{Angle}2 = (\text{Radial}2 + \text{Radial}1) / 2 + 180^\circ = 230^\circ$. Attention should be paid with northerly directions.
- $\text{Angle}1 = (\text{Radial}2 - \text{Radial}1) / 2 = 20^\circ$.
- $\text{Radius}1 = \text{Max.radius} = 200 \text{ km}$.
- $\text{Radius}2 = \text{Min.radius} = 50 \text{ km}$.

9.2 Flying a Task

After take-off the unit will switch to flying mode. The pilot will notice this because the statistics page will change from logbook view to flight statistics.

9.2.1 Starting a Task

Before starting a task (in task mode) a character "**S**" will be displayed on the final glide symbol. This indicates that the task has not yet been started. The lower number tells you at what altitude you will start. More advanced start options such as maximum start speed, maximum altitude, before start altitude or event procedure are described in following chapters. There are two options to start a task.

Via the START Button

Once you decide to start the task and glider enters start observation zone, the message "*Inside start zone*" will be displayed.

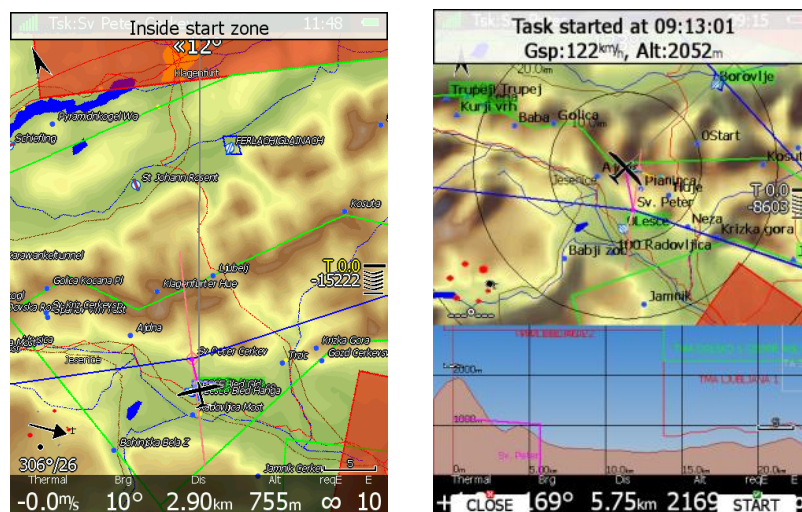

You may now leave the start observation zone and fly towards the first turn point. When leaving the start observation zone, the message "*Task started*" will be shown.

Ground speed and pressure altitude are also shown in the message. At the bottom two buttons are displayed. Use the **CLOSE** button if this was not a valid start and you want to remove the message from screen. If the message is removed it will appear again next time you leave the start zone. If you press the **START** button navigation will be advanced to the first turning point.



There is no need to press **START** inside the start observation zone. You may press it any time after leaving the start observation zone or crossing the start line. The system will always take the correct time as start time.

If for some reason you miss the start message you may always start the task by pressing the **START** button. Enter task mode and press any button. In the bottom row the **START** button is shown. Press this button and navigation will be advanced to the next turn point. In case you change the task in the air and you are already flying towards first turn point you will still be able to start a task. Press the **START** button and a message dialogue to confirm task start will be opened.

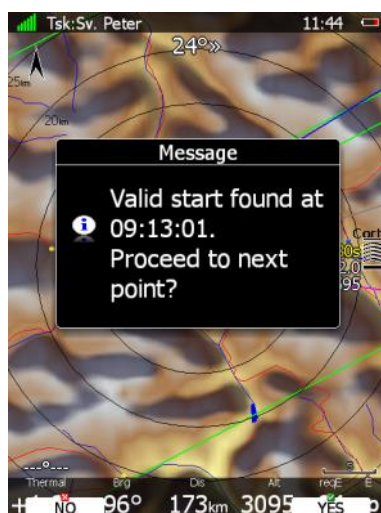

Via the ARM Button

You can enable this mode using Task Options dialogue. In this mode you have to ARM start prior to starting the task. Before crossing the start line or before leaving the start zone press the ARM button. The message "Task armed!" will be displayed. The ARM button will be now replaced by the START button.

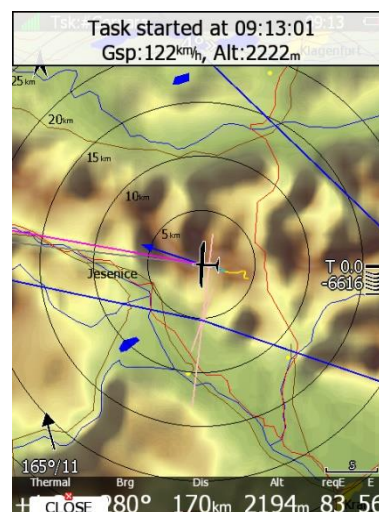
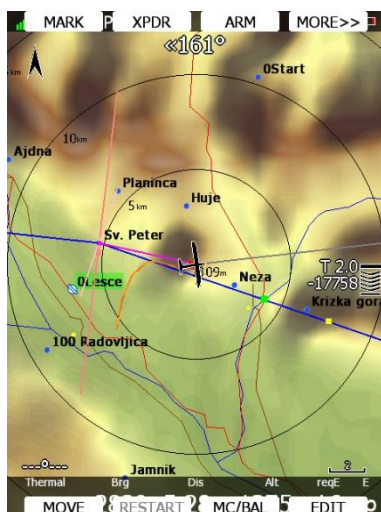

On next valid start the task will advance to the first point automatically and the message "Task started" will be displayed.

9.2.1.1 Below Altitude Start Procedure

On some competitions there is a rule that a pilot must be below a defined altitude for a certain amount of time. In Task option dialog (see chapter 5.7.2.4) enter **Below alt.** and **Below time** parameters to use this procedure. An indication will be given on the final glide

symbol. Character "B" will be displayed before the MacCready value which indicates that the final glide is in below altitude mode.

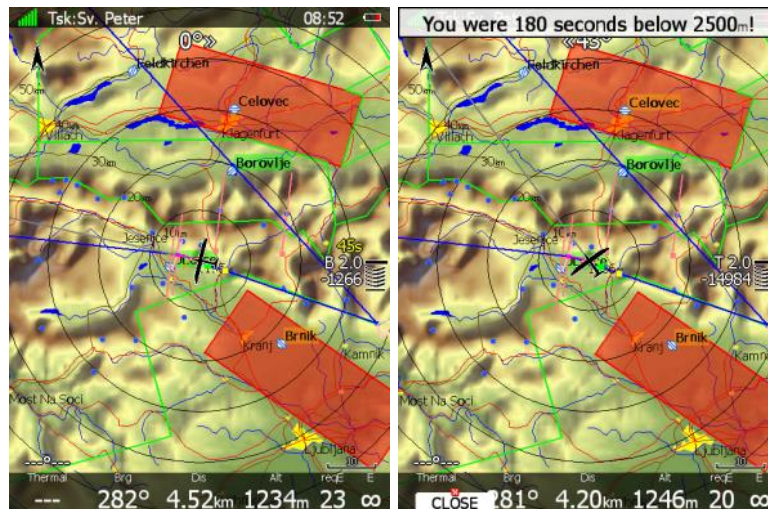

The lower number shows the difference to the set altitude. Negative values mean altitudes below set altitude. The upper yellow number indicates the number of seconds left to be below the set altitude. Chevrons indicate meters below or above required altitude. Each line represents 10 m. A message "You were XX seconds below YYYY m!" is displayed once you fulfil the conditions.

9.2.1.2 Maximum Start Speed and/or Maximum Start Altitude

Many competitions are limiting the start altitude and/or start ground speed. The system helps pilots to cross the start line at the correct altitude with correct ground speed. In Task option dialog (see chapter 5.7.2.4) enter **Start alt.** and/or **Start gsp.** parameters to use this option. An indication will be shown on the final glide symbol. Character "A" will be displayed before the MacCready value if a start altitude was entered and/or character "G" will be displayed if a start speed was specified. AG combines both **A** and **G**.

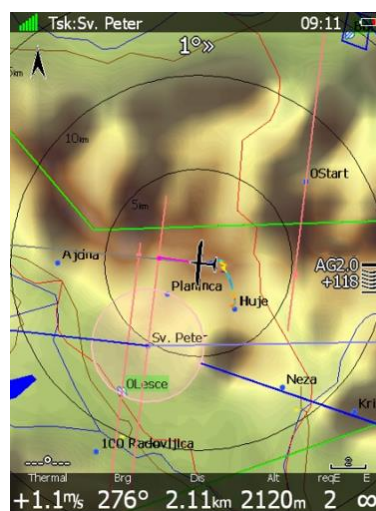

The lower number indicates at what altitude you will reach start altitude. A negative value indicates you are going to be there below the required start altitude.



The arrival altitude to start is not based on MacCready, the glider nor the wind settings. It is calculated based on energy difference during flying straight. This gives a very precise estimate at what altitude you will arrive at the start. Speeding up will result in greater energy loss and the arrival altitude will decrease; slowing down to best glider ratio will decrease energy loss and the arrival altitude

will increase.

The chevrons indicate if you have to slow down, or you may speed up. In the picture above, we are 118 meters above the glide to start altitude. Chevrons show that we can speed up.



Start speed and start altitude mode is available only if the **Navigate to nearest point** is checked.

9.2.1.3 Event start procedure

When event start procedure (PEV Start) is in use, pilot must record an event before crossing the start line or exiting start zone. After pressing the event button, a wait time period starts. When this period finishes, start interval will open in which a penalty-free start may be made. These two parameters can be set in task options dialog. See also chapter 5.7.2.4.

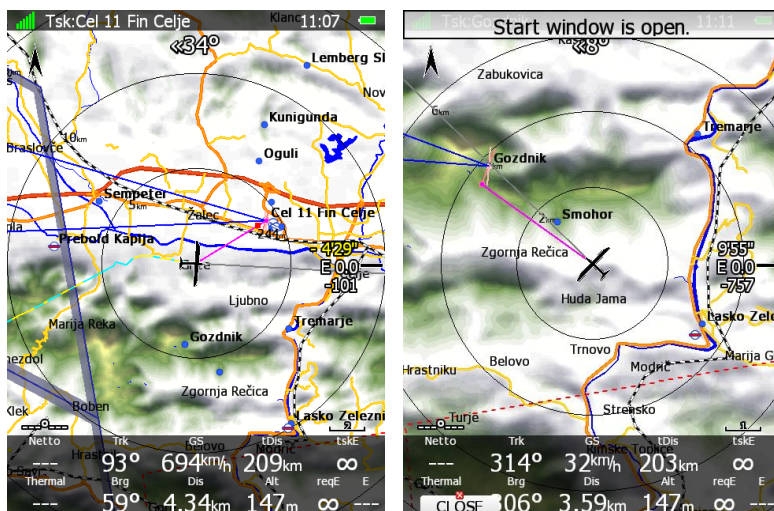

Press ARM or EVENT button to trigger event start procedure. Orange coloured timeout will be displayed in top row on final glide symbol counting down wait time period. Once count down is finished a message "Start window is open." will be shown and start interval countdown in default colour will start count down in top row of final glide symbol.

When pilot sees this countdown, a penalty free start can be done.

Event button may be pressed at any time, up to a total of **Max.events** times (See chapter 5.7.2.4.). Each press of PEV cancels the previous start window and restarts the wait time timer.



Multiple events recorded within 30 seconds will be treated as a single event at the time of the first event of the cluster.

Wait time interval and start window interval countdowns are displayed on final glide symbol. Next to letter "E" number of recorded events for current flight is shown. See also chapter 6.3.4.1.

On the next graph a scenario with final glide symbol is shown. It is assumed that wait time interval is 5 minutes, start window is also 5 minutes and maximum number of events is three.

<p>EVENT or ARM is pressed. Wait time countdown started.</p>	<p>EVENT is pressed within 30seconds from previous event. Nothing happend, count down continue and number of events is still one.</p>	<p>EVENT is pressed after 30seconds from first event. Wait time countdown is restarted and events counter is increased.</p>	<p>Wait time period is finished and start window countdown has started. In this window pilot can make a penalty free start.</p>	<p>EVENT is pressed for the third time. Wait time countdown started and events counter is increased to three.</p>	<p>EVENT is pressed for the fourth time. Maximum number of events is exceeded, what is indicated with label max. Start is possible, but penalty points will be applied.</p>

9.2.2 Restarting a Task

If for some reason you decide to abandon the task and you would like to restart the task go to task mode and press any button. In the top row the **RESTART** button is shown – press it. You have to confirm restarting of the task. Once the task is restarted navigation will be changed back to the start point.

9.2.3 Over Turn Point

When a turn point observation zone is reached the message "Inside zone" will be displayed and the task will auto advance to the next turn point if the **Auto next** option was selected.



If the **Auto next** option has not been selected the message **NEXT** will be displayed. Press the associated button to advance to the next turn point. If for some reason you missed this message you can always advance the task to the next turn point by pressing the **NEXT** button. Go to task mode. In the upper row the **NEXT** button is shown. Press this button and navigation will be advanced to next turn point.

In case you did not reach turn point and you wish to continue navigation towards the following point anyway press the **NEXT** button.



A message will appear. If you confirm this with **YES**, the task will be advanced to the next turn point and it will recalculate the task taking the optimal fix as the task point.

9.2.4 Entering Assigned Area

Most probably when entering an assigned area auto advance is going to be turned off. The message "Inside zone" will be shown and buttons **CLOSE** and **NEXT** will appear in the lower row. Pressing the **CLOSE** button will dismiss the inside zone message. The task will be auto-advanced to the next point when leaving the assigned area. If you want to auto-advance to the next turn point earlier you may always press the **NEXT** button in task mode (see Chapter 9.2.3).

If **NEXT** is pressed the task is advanced to the next turn point.



When flying in an assigned area it is NOT important when you will advance to next turn point. The system is always taking into account the most optimal fix inside the assigned area for the total distance calculation.

9.2.5 Moving Point Inside Assigned Area

If at least one observation zone is defined as an assigned area, it is possible to move the point within this area. Moving the point will increase or decrease the total task length. Select the **MOVE** action within task mode. A dialogue with the current assigned area will be shown.

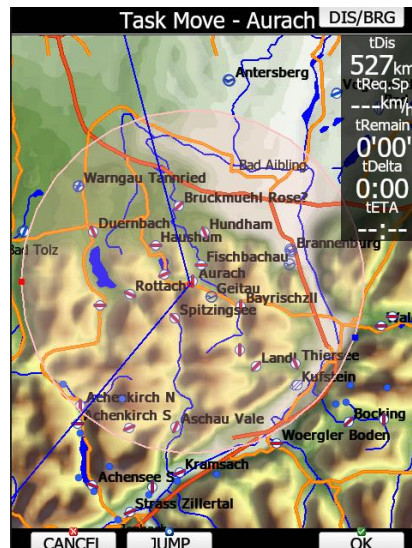
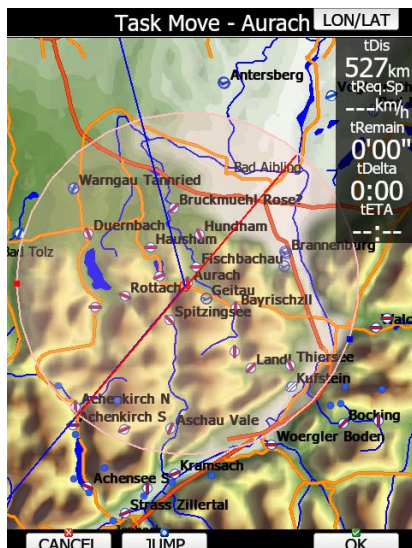

In the upper-right corner the remaining task distance is shown as well as the required task speed, remaining task time, delta time and estimated time of arrival.

Delta time is the difference between the remaining time and time of arrival. If it is negative you will arrive back too soon and if it is positive you will arrive too late.

Keep in mind that the time of arrival can be calculated using different methods which are found in the QNH and RES setup (see Chapter 5.1.1).

A point is moved using the lower two knobs.

Press the **DIS/BRG** or **LON/LAT** button to toggle between the two methods of moving the point.

When the **DIS/BRG** button is shown the point is moved in the x, y direction. Use the PAGE selector knob to move the point in north/south direction or rotate the ZOOM selector knob to move the point in east/west direction.

If the **LON/LAT** button is shown the point is moved in radial and azimuth direction. Radial direction is indicated with red line drawn through the whole sector. Rotate the PAGE selector knob (page selector) to move the point in the radial direction from the area centre. Use the ZOOM selector knob (zoom) to move point in the axial direction.

Pressing **JUMP** will move the point between centre, minimum distance and maximum distance.

If more than one assigned area is set for a task the **NEXT>>** button is shown in the lower line. Press this button if you would like to move the point into another assigned area.

When moving a task point to which you are navigating, and AAT optimization is enabled (see Chapter 5.1.7.8) additional lines will be shown in zone. A line represents equal task speed, therefore the pilot should fly always perpendicular to these lines in order to maximize performance. Lines are calculated based on ETA calculation.

9.2.6 Task Finish

When reaching final glide, a message "Task on final glide!" will be displayed. The main display unit will also warn you when you are two minutes from the finish. On entering the finish zone, the task stops automatically and a message will be displayed.

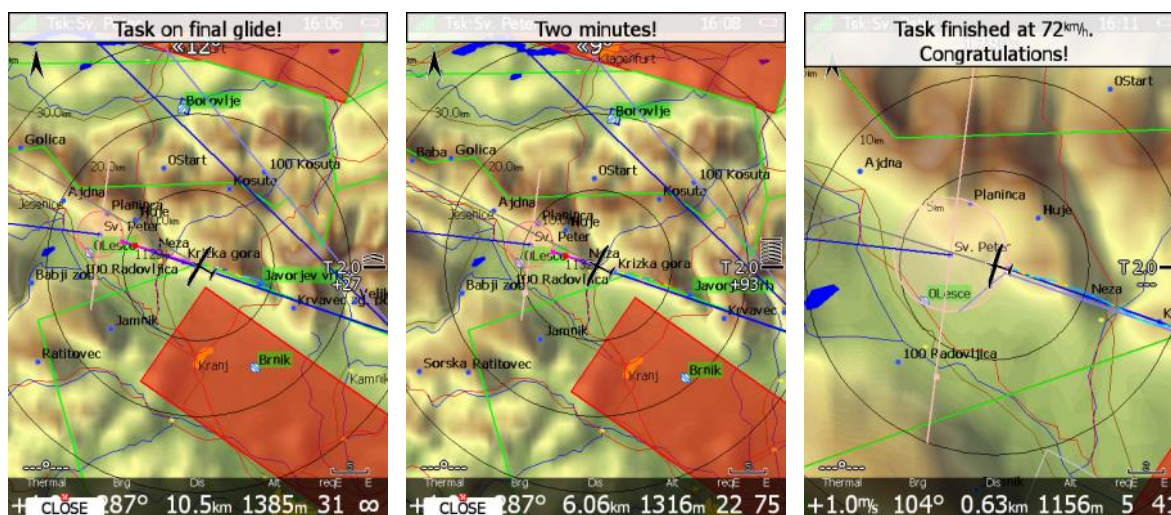

If you want to fly a new task without landing, load the new task and press the **RESTART** button.



The **Navigate to nearest point** option is very useful and actually a must if a finish cylinder is used with significantly large radius. Enabling this option will calculate the final glide to the edge of the cylinder rather than to the centre of the cylinder.

9.2.7 Graphical Final Glide Assistants

There are a number of graphical final glide assistants available:

- Glider range (outside/inside fill)
- Different colours of APTs in near mode list
- Different colours of APTs on the map
- Square symbols

Glider range can be filled outside or inside. Different fill types, colour and opacity can be set as shown in Chapter 5.1.7.5.

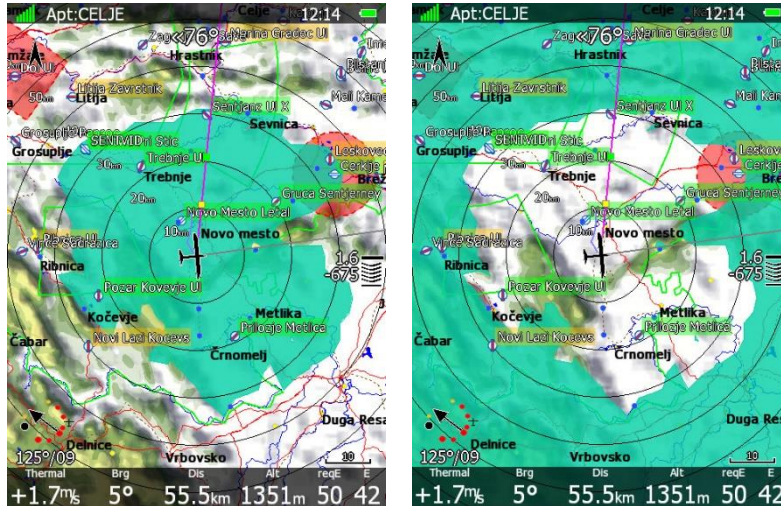

In Near mode arrival altitude is coloured white, yellow and red. White final glide shows APT in range at current MC setting. Yellow final glide shows reachable airports if you decrease your MC to zero. Red colour means these APTs cannot be reached. The same colour logic is used for the APTs appearance on the map.

Near				
Name	Dis.	Brg	Arr	
Novo Mesto Letal	8.00km	336°	549m	
Prilozje Metlica	18.8km	154°	-158m	
Gruca Sentjerney	20.3km	55°	-205m	
Trebnje UI	22.1km	328°	-333m	
Pozar Kovevje UI	22.5km	247°	-591m	
Novi Lazi Kocavs	29.8km	230°	-1109m	
Sentjanz UI X	29.8km	4°	-856m	
Sentvid Pri Stic	32.5km	313°	-950m	
SENTVID	32.5km	313°	-953m	
Ribnica UI	33.7km	273°	-1216m	
Cerklje Mil	33.9km	59°	-1000m	
Leskovec UI	34.8km	54°	-1097m	
Vince Sadrazica	36.9km	271°	-1410m	
Mihalo Dobova	41.8km	66°	-1469m	
Mali Kamen Topol	42.0km	40°	-1589m	
Litija Zavrstnik	42.6km	322°	-1476m	



A **Yellow square** indicates final glide at MC 0. Once you reach the **green square** the LX will give you a message "Task on final glide" assuming the current MC setting.



9.3 Procedure After Landing

IGC Regulations require a straight line (base line) in the barogram at the beginning and end of the flight. For this reason, that it is essential **not to switch the unit OFF** immediately after landing, but to wait a few minutes. First the message "*Flight will finish in 10 seconds*" will appear and then the message "*Calculating security!*"

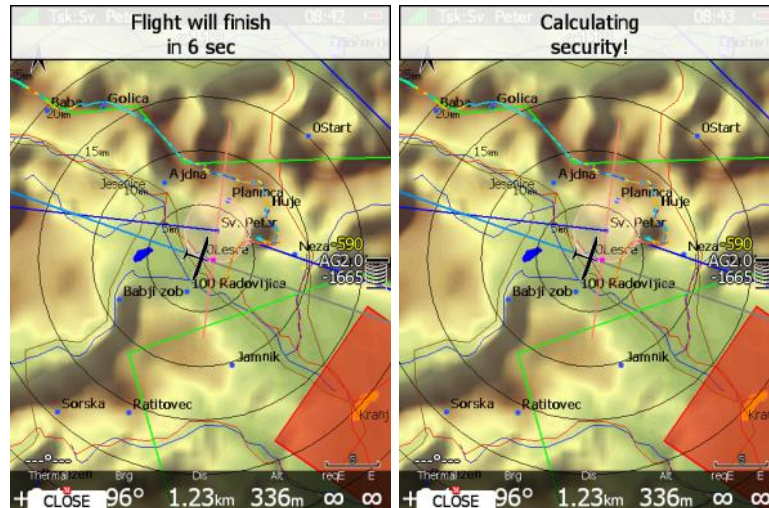

The flight is finished when the message *Calculating security* disappears. At that moment the statistics page will be changed back to logbook view. Now it is safe to switch off the instrument.

If a SD card or USB stick is currently inserted into the main display unit, the flight will automatically be copied to it.

Please use regular methods to power down the system. See Chapter 4.4 for details.



It is important that the system is switched off via software. Never power down the system using the main power switch. The main display unit is running the Linux operating system and sudden power loss may corrupt the file system.

10 Firmware Update

Firmware updates of the main display unit, vario unit or vario indicator can be easily carried out using a SD Card or USB stick.

A user can always choose between official public release and beta public release. Official release features updated manual and was extensively tested by us and many other users in flight. Usually one or two official releases are published per year. All official releases are located on this address: <https://gliding.lxnav.com/lxdownloads/firmware/>.

The other option is public beta release. Public beta release will have a lot of new functionality added. Before going public beta, we have tested it in our company and while flying. Usually manual is not updated at that stage. You can find latest beta versions here: <https://gliding.lxnav.com/beta/>.

You will have to send us a request for the update code. Update code will be sent to you via email. Firmware request form can be found here <https://gliding.lxnav.com/firmware-request/>.

Update code is same for official version and all published beta version.

Here you can also find useful information about the new version by clicking "i" icon next to the software version.

Firmware

Product	Description	Version	Date	Size	File
All					▼
LX80xx, LX90xx	Latest firmware for navigation device range (includes firmware updates for peripheral devices)	7.13 ⓘ	27 Nov 2019	-	📄
Changelog 0					
Version 7.13					
Bug fixes:					
<ul style="list-style-type: none"> Fixed invalid layout of "Polars" and "Flaps" dialogs 					
Version 7.12					
Bug fixes:					
<ul style="list-style-type: none"> Fixed airspace dismiss bug (introduced in v7.11) Fixed LX9000 portrait user interface layout bug 					

Update can be also done through Wi-Fi (if internet connection is established and the Wi-Fi module is enabled on the LX system).

You can also subscribe to a newsletter to receive news about the system automatically.



After firmware or during firmware update, no data or no response from vario are normal messages.



Updating LX8030 and 8040 instruments via SD-card is only possible if you have the addon SD-card reader. It is recommended to update this devices via integrated Wi-Fi module as described in Chapter 9.11

10.1 Updating the Main Display Firmware

We will send you an update file and update code. The update code is a string six letters long and the update file has the **.lx8000**, **.lx8080**, **.lx8030**, **.lx8040**, **.lx9000**, **.lx9050** or **.lx9070** extension. To proceed with the firmware update, copy the update file to a SD card or USB stick and insert it into the main display unit.

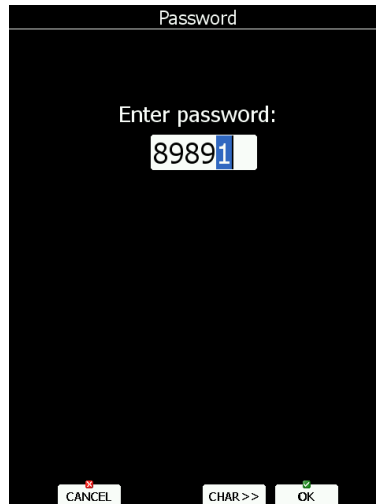

Start the main display unit and go to the Setup->Password menu option.

Enter password **89891** and press **ENTER**.

The system will automatically search for an update file. If more than one update file is found a selection dialogue will appear.

After the update file is selected an update code must be entered.

Enter the update code which was sent to you (example below).

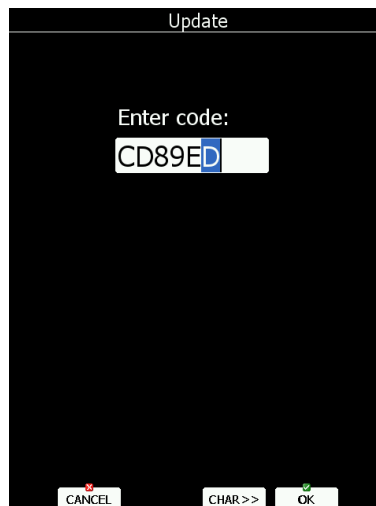

Please note that the update file and update code are a matching pair only applicable to a particular serial number.



If you are using a second seat device (LX9000D, LX9050D, LX9070D, LX8030D, LX8040D, LX8000D or LX8080D), it must be updated separately by using the same procedure as described in this chapter.

Once the update file is verified the main display unit will reboot and the new firmware is ready for use.

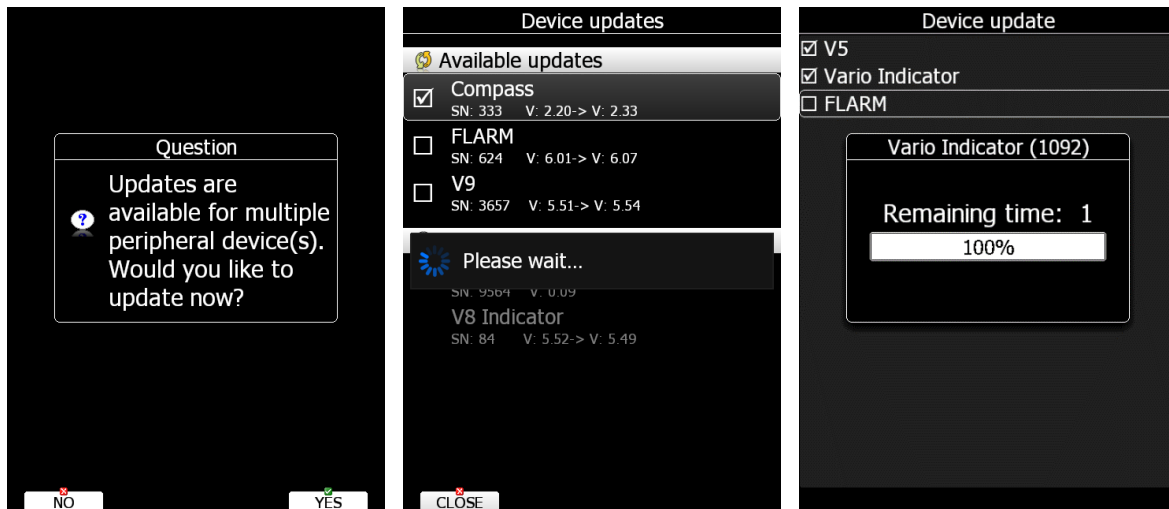

After the first reboot the main display unit will also update all devices connected to the 485 bus and Flarm device. On average this update will take approximately five minutes.

10.1.1 Updating Via Wi-Fi Module

With the SW version 6.0 onwards it is also possible to perform an update without a SD card or USB stick. Once the internet connection is established, the system will automatically give you a notification that there is a new update available. The user has 3 options available **update** – which will perform the update, **ignore** – this message will be ignored and it won't be shown anymore for this version and **later** option – which will notify you after each restart.

The update button will download the version, make an update and display a message "update successful" After that the system will perform a restart. The user will also be asked to make an update of peripheral devices. We suggest you to confirm it and update all devices.

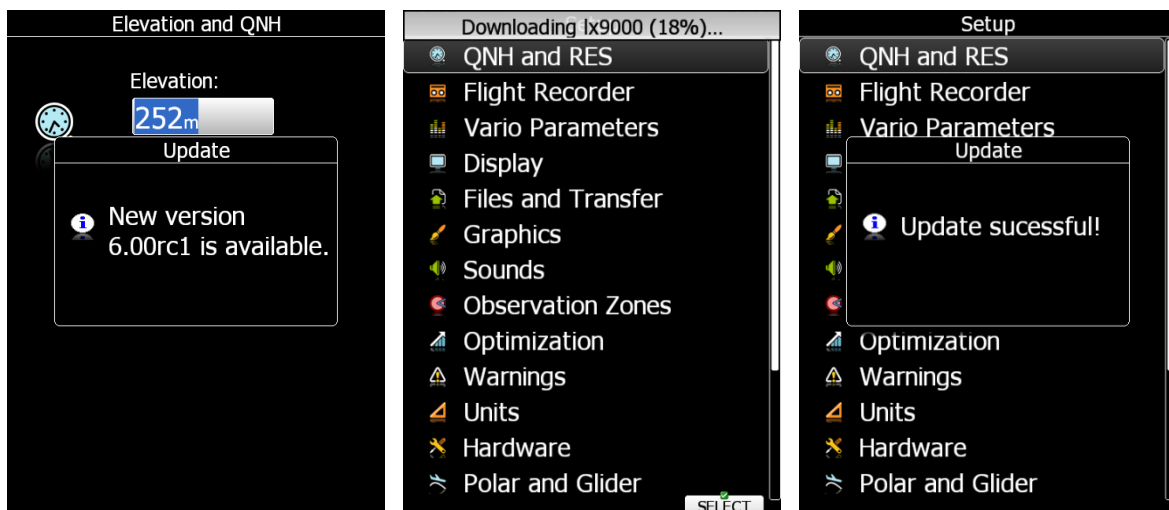

Updates are also possible via the SETUP->ABOUT page, where there is the button UPDATE (button is grey if there are no new Updates available). The user can update the LX system with the SW version or perform a Database update.

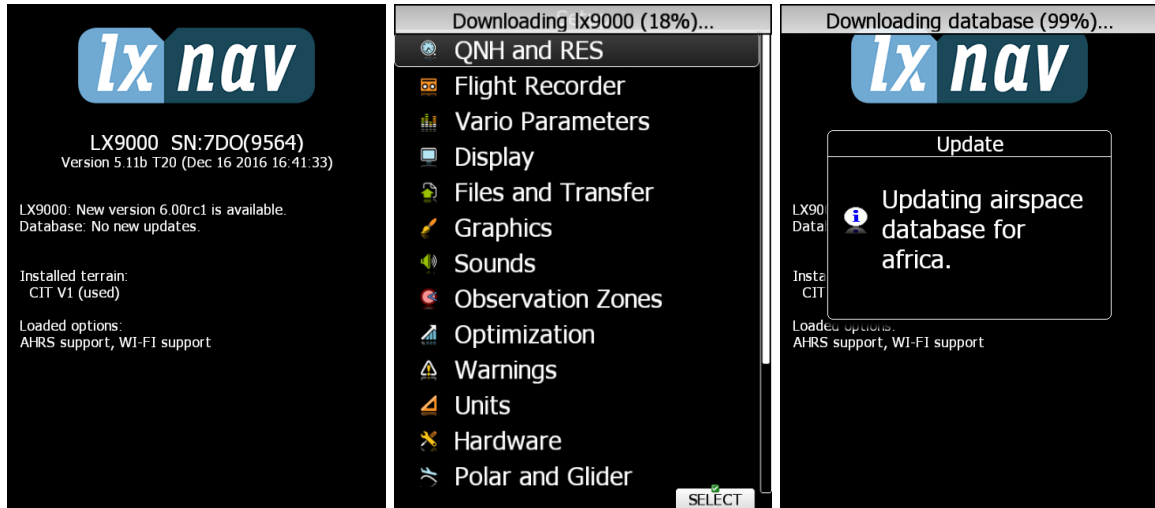

10.2 Updating Vario Unit or Vario Indicator

10.2.1 Automatic Vario Update

Once you update the main device, after the reboot you will see the following message/question:

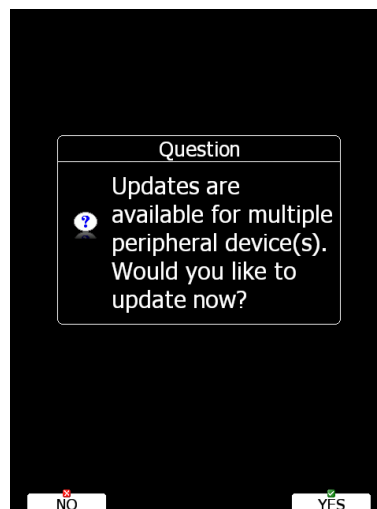

It is advised to select YES and update the vario unit (V8/V80).

All detected devices will be listed, including 2 vario parts:

- Sensor box (Automatic method)
- V8/V80 indicator (Manual method)

Select both and press UPDATE. The sensor box will be automatically updated in less than a minute. After that a manual update of the V8/V80 is required. Please follow instructions displayed on the LX80/90xx.

The instructions are:

- You will be asked to prepare the micro SD card adapter and press OK,
- Then you will be asked to take the micro SD card from the V8/V80 and insert it into LX80/90xx by using the SD card adapter (if your card inserted in the LX80/90xx already comprises the SD card adapter and the micro SD card, then you can simply ignore this message), then press OK.
- Copying of the firmware will be performed.
- When you get a message with action, please take the micro SD card from the LX80/90xx and insert into the V8/V80.
- The V8/V80 will detect the micro SD card and will automatically ask you: UPDATE?... Confirm it with the middle button on the V8/80 which will perform a restart and a SW update.
- Once the update is successfully booted, you can check your latest version in the SETUP->ABOUT menu in the V8/V80 vario unit.
- On the LX80/90xx you can terminate the message by clicking the OK button.



A micro SD card adapter is needed for a manual V8/V80 update. Old LX8000 display units only work with SD cards up to 2 GB in size (the 8 GB mini SD card supplied with the V8 vario is not recognised by the old LX8000 display). All other units support SD cards up to 16 GB.



If you have LX8030/8040 device without SD card reader, you have to manually update vario as described in the next chapter.



Varios older than V5 are no longer supported in the firmware versions 8.0 and above.

10.2.2 Manual Vario Update

Download the vario file from www.lxnav.com and put it on the SD card.

Start the system, insert the SD card and go to the Setup->Password menu option.

Enter password **89891** and press **ENTER**.

The system will automatically search for an update file. If more than one update file is found a selection dialogue will appear.

Select appropriate update file and wait until update completes.

10.2.3 Manual V8/V80/I8/80 Update

Download the file from the website, rename it to zip extension and unzip the file.

The unzipped folder should contain 2 files:

- V8x.fw
- V8x_init.bin

If any of these files are missing or are corrupt the firmware update will not be successful. Transfer the firmware update files to the micro SD card and insert it into the V/I8x. The unit will ask you UPDATE? Confirm and reboot the V8x unit. The update will be performed automatically.

11 IGC Barograph Recalibration Procedure

The main display unit has an additional pressure sensor for altitude recording. To comply with IGC procedures this sensor has no external pneumatic connection. To carry out the barograph calibration procedure it is necessary to remove the instrument from the glider and place it in a vacuum chamber. The procedure is as follows:

- Switch the instrument ON and wait some minutes (straight line on the barogram beginning).
- Set the recording interval to 1 second (see Chapter 5.1.2).
- Place it in the chamber and carry out a short climb to about 100 m (to start the flight recorder).
- Bring the chamber pressure to exactly 1013.2hPa.
- Decrease the pressure by 1000 m and hold for about 30 seconds.
- Continue the procedure to 9000 m.
- Increase the pressure in 1000 m steps back to 1013.2hPa.
- After reaching ground wait about 3 minutes and then switch the instrument off.
- Leave the instrument off for at least 5 minutes.
- Download the last flight and print the barogram.
- Restore the flight recorder settings.

The barogram will be the last flight in the logbook.

12 Software options

12.1 AHRS option

To activate AHRS option an activation code and file must be purchased. Please contact LXNAV or local dealer to purchase an option. To get activation code and file, you will have to provide serial number of the main unit.



Once the activation code has been purchased, this option is permanently active on the selected device. Option cannot be deactivated or transferred to another device.

Installation process of option is very straight forward process. We will send you the file with AHRS option and activation code. The activation code is a string six letters long and the option file "add_ahrs" has the **.lx8000**, **.lx8080**, **.lx8030**, **.lx8040**, **.lx9000**, **.lx9050** or **.lx9070** extension, depend on the instrument type. To proceed with the firmware update, copy the update file to a SD card or USB stick and insert it into the main display unit.

Start the main display unit and go to the Setup->Password menu option.

Enter password **89891** and press **ENTER**.

The system will automatically search for an option file. If more than one file is found a selection dialogue will appear. After the option file is selected an activation code must be entered. Once activation code is entered, option will be installed and result message will be displayed.

12.2 HAWK option

To activate HAWK option or HAWK demo option an activation code and file must be purchased. Please contact LXNAV or local dealer to purchase an option. To get activation code and file, you will have to provide serial number of the main unit.

HAWK demo option can be requested via following address <https://gliding.lxnav.com/hawk-demo-request/>.



Once the activation code has been purchased, this option is permanently active on the selected device. Option cannot be deactivated or transferred to another device.

Installation process of option is very straight forward process. We will send you the file with HAWK option and activation code. The activation code is a string six letters long and the option file has the **.lx8000**, **.lx8080**, **.lx8030**, **.lx8040**, **.lx9000**, **.lx9050** or **.lx9070** extension, depend on the instrument type. To proceed with the firmware update, copy the update file to a SD card or USB stick and insert it into the main display unit.

Start the main display unit and go to the Setup->Password menu option.

Enter password **89891** and press **ENTER**.

The system will automatically search for an option file. If more than one file is found a selection dialogue will appear. After the option file is selected an activation code must be entered. Once activation code is entered, option will be installed and result message will be displayed.

12.3 Club options

To activate any of club options an activation code and file must be purchased. Please contact LXNAV or local dealer to purchase an option. To get activation code and file, you will have to provide serial number of the main unit.



Once the activation code has been purchased, this option is permanently active on the selected device. Option cannot be deactivated or transferred to another device.

Installation process of option is very straight forward process. We will send you files with purchased club options and activation codes. The activation code is a string six letters long and the option file has the **.lx8000**, **.lx8080**, **.lx8030**, **.lx8040**, **.lx9000**, **.lx9050** or **.lx9070** extension, depend on the instrument type. For each club option, you will get a separate file and activation code. To proceed with the firmware update, copy the update file to a SD card or USB stick and insert it into the main display unit.

Start the main display unit and go to the Setup->Password menu option. Enter password **89891** and press **ENTER**.

The system will automatically search for an option file. If more than one file is found a selection dialogue will appear. After the option file is selected an activation code must be entered. Once activation code is entered, option will be installed and result message will be displayed.

13 Hardware options

13.1 FLARM / POWER FLARM



Before using FLARM it is highly recommended to read the FLARM user manual which can be downloaded from www.flarm.com. Respect all limitations listed in this document.

FLARM is a collision avoidance system developed by FLARM Technology AG from Switzerland. The FLARM module consists of following main parts: GPS receiver, microcontroller unit, radio transceiver pressure altimeter and optional an external indicator. All electronic parts are integrated into the main display unit cabinet. An exception is the radio communication antenna and the FLARM External Display. Some input is possible via the external display.



If the display unit does not have built FLARM, an external FLARM connection is possible using the LX5flarm or LX5PF cable for Power FLARM.

13.1.1 Installation



For more detailed instructions on installation, please refer to the installation manual.

The position of the radio communication antenna is extremely important as a bad installation will reduce the system range dramatically. It is highly recommended to install the antenna on the top of the instrument panel with a suitable aluminum round plate having a diameter of about 12 cm used as a back plane and an approximately 10 cm long rubber antenna used as the radiator. The metal plate may be mounted outside or inside of the instrument panel. If carbon is used, use only the top mounting variant.

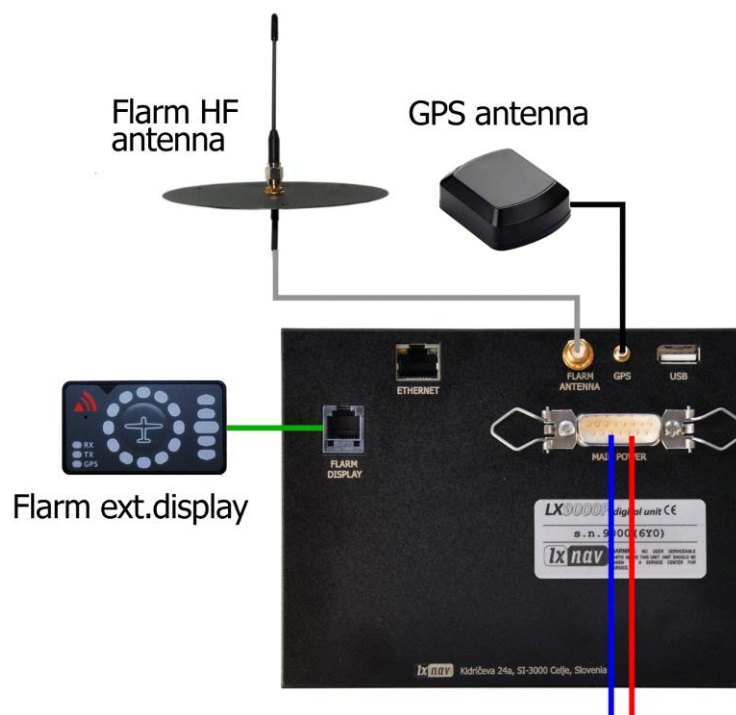



The antenna position must be mounted as vertical as possible. Use only the original antenna which is always delivered with the unit. Use the original cable to connect the main display unit to the antenna. Never use an antenna without the original aluminium ground plane. If there is no space to install the metal ground plane a dipole variant of the antenna is available. The picture above shows the connected GROUND PLANE antenna. With the LX system a DIPOLE antenna is included which has an even better performance than a ground plane antenna.

The FLARM external display is a small unit and can be placed anywhere on the instrument panel. To fix the device, use self-adhesive tape on the back of the device. For installation on the top of the instrument panel a suitable box is available.

13.1.2 FLARM Update Procedure

The FLARM is updated via the SD card/USB stick. From the FLARM webpage (www.lxnav.com) download the appropriate file and copy it to the SD card (e.g. **cf_6_09_d4ec337.fw** for flarm and **pf_am_6_80_b1c88a304_exp_31_jan_2021.fw** for built in power flarm). Enter password **89891** and select the FLARM update file. Wait until it is completed.

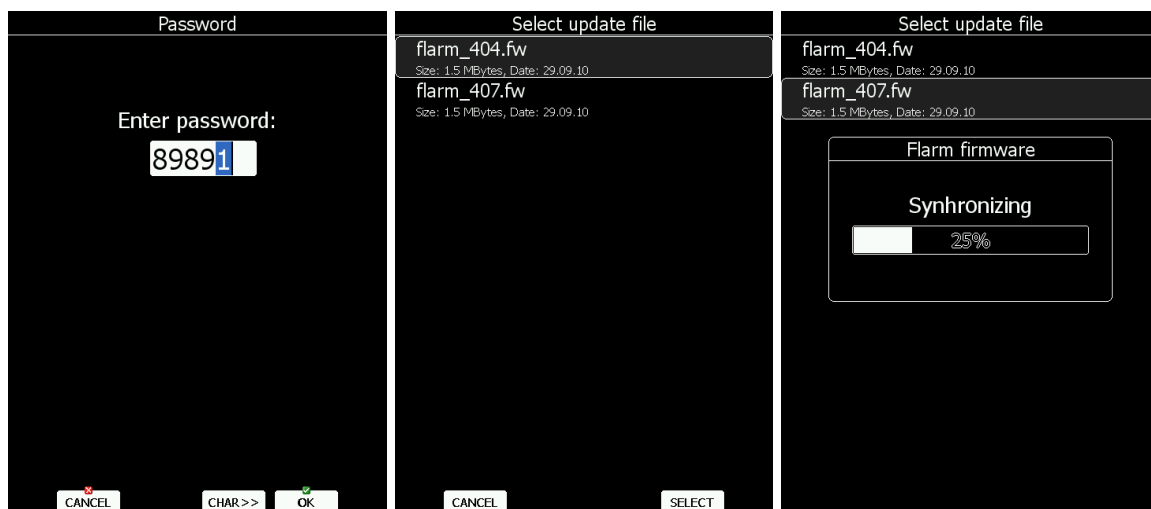

In case of a problem, it is still possible to perform an update using FLARM tool and the serial connection. Please refer to an older LX8000 manual for the detailed procedure.



External FLARM modules can be also updated via the LX system. PowerFLARM modules cannot be updated through LX systems.



For LX8030/8040 without SD card reader, use the USB port with USB stick.

13.1.3 Uploading Obstacles

The obstacle database is also updated via the SD card/USB stick. Alternatively you can also load database files via LXNAV Connect with Dropbox or Google Drive service (see chapter 5.1.15). Since version 6.0 obstacles are not free of charge and they are not preloaded on system. In order to purchase obstacle database, please note the FLARM serial number. The

FLARM serial number can be found in Flarm setup dialogue (see chapter 5.1.12.6). Go to the FLARM webpage to obtain obstacle the file and copy it to the SD card.

In the **Files and Transfer** menu select the **Update Databases** menu item. Select the obstacle file and wait until the update completes.

If you do not wish to use the obstacle database an empty database is available via www.lxnav.com.

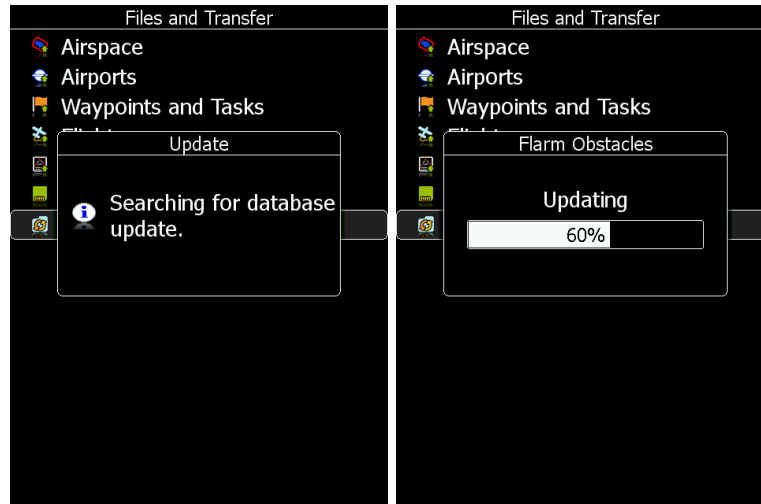

13.1.4 FLARM Update Procedure with FlarmTool from PC

Go into password menu and enter password 42000.



The following message will appear.

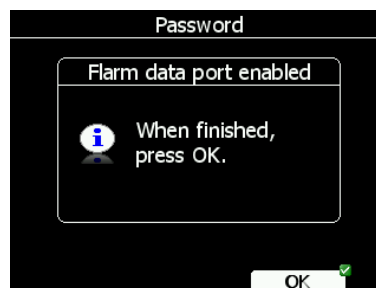

Run FlarmTool and select the communication port.

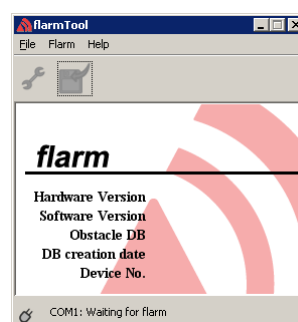

Connect the main display unit to your PC with the LX5PC cable. The FlarmTool will detect the FLARM unit. Please follow the instructions.

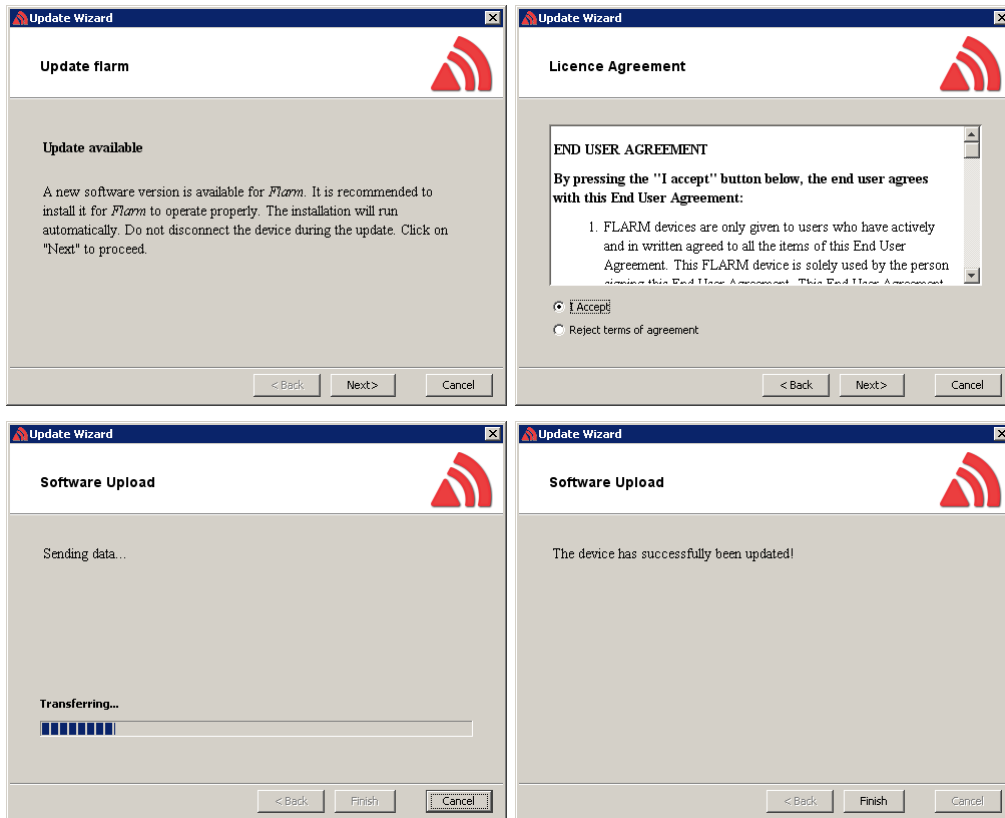

If the FLARM stops working and an update is not possible via the described procedure with password 42000, use following recovery procedure. In FlarmTool choose Recover and follow the instructions. On the LX8000 enter password 41000.



When the recovery is finished press the OK button.

13.1.5 Uploading Obstacles with FlarmTool From PC

Go into password menu and enter password 42000. Run FlarmTool and select the communication port. Connect the LX8000 via PC cable to your PC

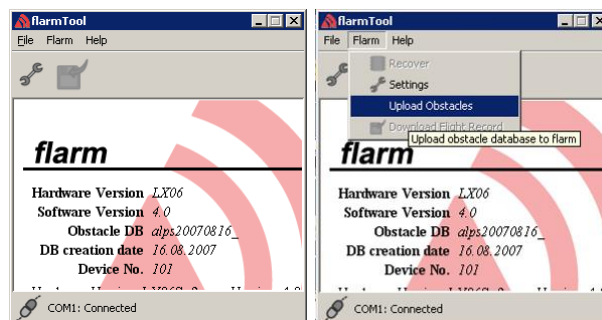

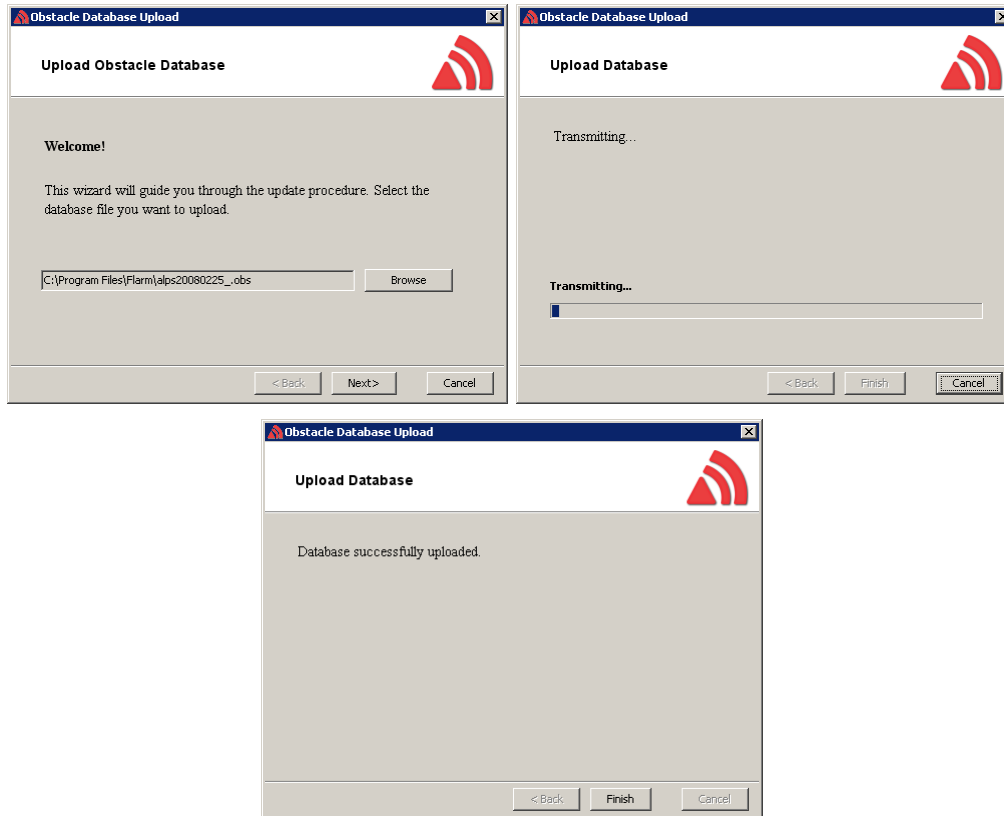

When finished, press the OK button on the LX8000.



13.1.6 Uploading FlarmNet Files

The FlarmNet information is also updated via the SD card/USB stick. Go to the FlarmNet site (www.flarmnet.org), select the **Download latest FlarmNet File** tab and download the file for the LX8000 (e.g. 20170819.fln). Copy this file to the SD card.

In the **Files and Transfer** menu select the **Update Databases** menu item. Select the FlarmNet file and wait until the update completes.



FlarmNet files are automatically uploaded to V8x variometer from the main device.

13.1.7 Flarm error codes

Error codes are displayed on LXxxxx screen, flarm displays or you can read it on flarm generated files on flarm's SD card (optional).

11 = Firmware expired (requires valid GPS information, i.e. will not be available in the first minute or so after power-on)
12 = Firmware update error
21 = Power (e.g. voltage < 8V)
22 = UI error
23 = Audio error
24 = ADC error
25 = SD card error
26 = USB error
27 = LED error
28 = EEPROM error
29 = General hardware error
2A = Transponder receiver Mode-C/S/ADS-B unserviceable
2B = EEPROM error
2C = GPIO error
31 = GPS communication
32 = Configuration of GPS module
33 = GPS antenna
41 = RF communication
42 = Another FLARM device with the same Radio ID is being received. Alarms are suppressed for the applicable device.
43 = Wrong ICAO 24-bit address or radio ID
51 = Communication
61 = Flash memory
71 = Pressure sensor
81 = Obstacle database (e.g. incorrect file type)
82 = Obstacle database expired.
91 = Flight recorder
93 = Engine-noise recording not possible
A1 = Configuration error, e.g. while reading flarmcfg.txt from SD/USB.
B1 = Invalid obstacle database license (e.g. wrong serial number)
B2 = Invalid IGC feature license
B3 = Invalid AUD feature license
B4 = Invalid ENL feature license
B5 = Invalid RFB feature license
B6 = Invalid TIS feature license
100 = Generic error
101 = Flash File System error
110 = Failure updating firmware of external display
120 = Device is operated outside designated region. The device does not work.
F1 = Other

13.2 External FLARM or PowerFLARM

If main display unit has no internal FLARM, the user has the possibility to connect it to an external FLARM or PowerFLARM. All FLARM/PowerFLARM items will be displayed on the navigation map with same functionality as is with a built-in FLARM.

The external FLARM/PowerFLARM can be connected to the main display unit with a **LX5FLARM** cable.

On the main display unit side LX5FLARM is connected to a 5-pin rounded connector. On the other end of the LX5FLARM cable is a 6-pin standard IGC RJ12 plug connector which is plugged into the FLARM/PowerFLARM port.

In case of a SIMPLE version, the FLARM should be connected to the GPS port.

The External FLARM connection can be enabled at SETUP->HARDWARE->FLARM->PORT. Port should be set to EXT.(PC).

13.2.1 Installation



For more detailed instructions on installation, please refer to LX80/90xx installation manual.

External FLARM/PowerFLARM units can be connected to the main display unit with a **LX5FLARM** cable.

On the main display unit side LX5FLARM has a 5-pin rounded connector. On the other end of the LX5FLARM cable is a 6-pin standard IGC RJ12 plug connector, which is plugged into FLARM/PowerFLARM port.



Using an improper type of cable may harm your display unit or FLARM/PowerFLARM units.

13.3 ADS-B update

To update the internal ADS-B you need to enter a password 89892 and select the update file, which should be on the SD card / USB key.

13.4 Rear Seat Device

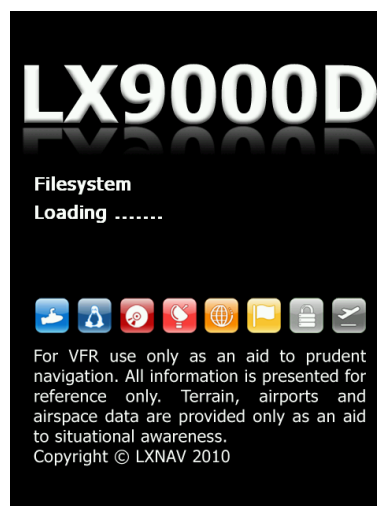

In two-seat gliders it is possible to install the rear seat device. The rear seat device looks almost identical to the main display unit. However, inside the device there is no GPS or FLARM module. The rear seat device must be connected to the main display unit only via the RS485 bus system. The basic idea of two-seat configuration is that both devices work

independently from each other with the possibility to exchange various data on user request or automatically.

13.4.1 Data Exchange

Because the GPS and FLARM modules are not integrated in the rear seat device this data is received from the main display unit through the RS485 bus. After power on and pilot selection, the main display unit also sends polar data and pilot information so that they are synchronized in both devices. The user can define which data will be automatically synchronized between the devices.



Waypoint and task databases are not synchronized between the devices. In order to have databases synchronized, you must use the SD card and copy files from the rear to front device or vice versa. See Chapter 5.1.6.5 for how to copy waypoint files.

To set up data which is going to be received from the rear seat device, enter the "Rear seat device" menu on the main display unit (see Chapter 5.1.12.8).

To define which data is going to be received from the main display unit go to the "Front seat device" menu (see Chapter 5.1.12.8).

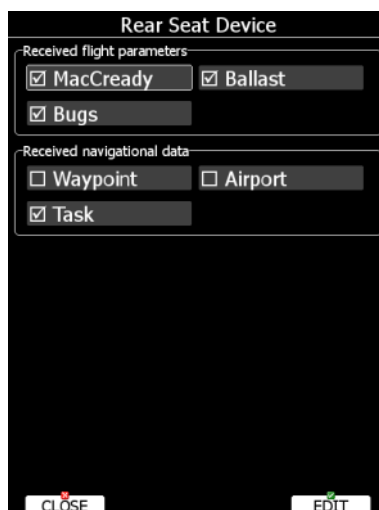

Data are divided into two groups; flight parameters and navigational data. If a specific value is checked this value will automatically be received from the other device.

Check **MacCready**, **Ballast** and/or **Bugs** to receive the current MacCready value, current ballast setting or bugs from the other device.

If **Waypoint** is checked a new waypoint target will be automatically assigned when the user changes the waypoint target on the other device. A message "*Waypoint target received*" will be shown on the screen and you will be navigating to the same waypoint as other device. Please note that it is not necessary to have this waypoint in your databases as the complete waypoint information is sent. If **Waypoint** is not checked it is still possible to send a target to another device using the **SEND** action in waypoint mode. The same applies to the **Airport** checkbox. The message "*Airport target received*" is displayed. If the **Task** checkbox is checked the task will be synchronised with the other device.



When flying an assigned area task, it is worth having **Task** unchecked. This will allow one pilot to play with "what if" scenarios. Once a proper direction is found the task can be sent to the other device using the **SEND** action in task mode.

13.5 Remote Control

The Remote Control stick is available in three different versions: Normal, with a red starter button or with a trim switch.



The stick is available also in various diameters: 18 mm, 19.3 mm, 20.3 mm, 24.4 mm and 25.4 mm. All necessary electronics is built into the top of the stick. The four coloured wires from the bottom must be connected to a RS485 splitter. Additionally, two shielded cables are used for speed to fly command and push to talk button (not valid for remote sticks delivered after 2016.)



Remote sticks produced after 2016 come without the SC and VP cables; they are programmable in the LX80xx/90xx menu.

13.5.1 Functions

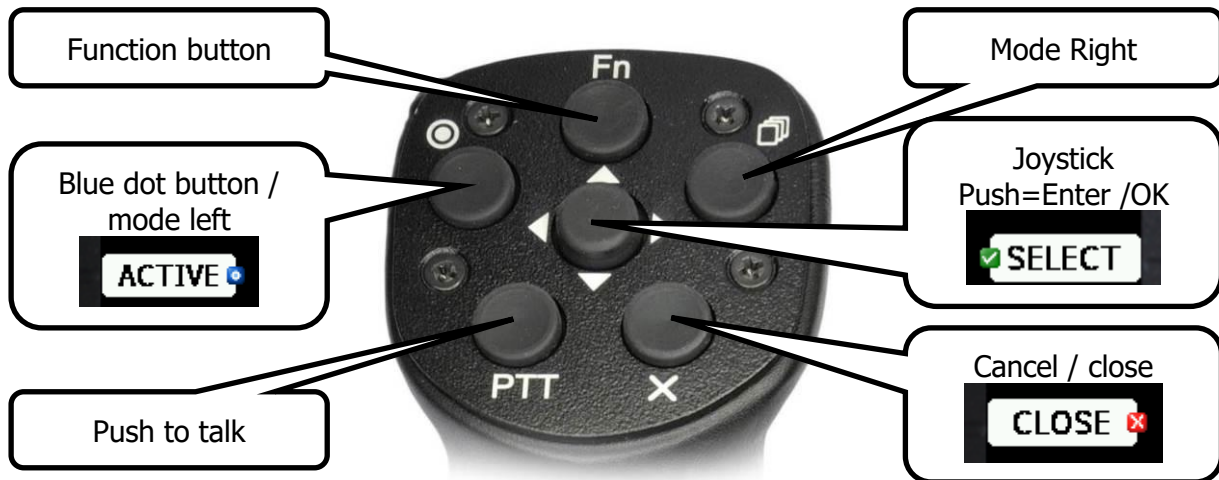

The remote stick has six push buttons and a multi-directional button in the middle. Move the multi-directional button left and right to zoom in and out. Move it up and down to select a different page or to move within a menu. Press it to select an item or to invoke a menu in navigational mode.

On the main display unit some of the speed buttons have a small icon. There are three icons available: a **red cross**, which correspond to the X button on the remote, a **blue dot** which correspond to the upper-left button with a dot and a **green tick**, which is the middle button.

The function button is a custom button, whose function can be set by the user (see Chapter 5.1.12.9).

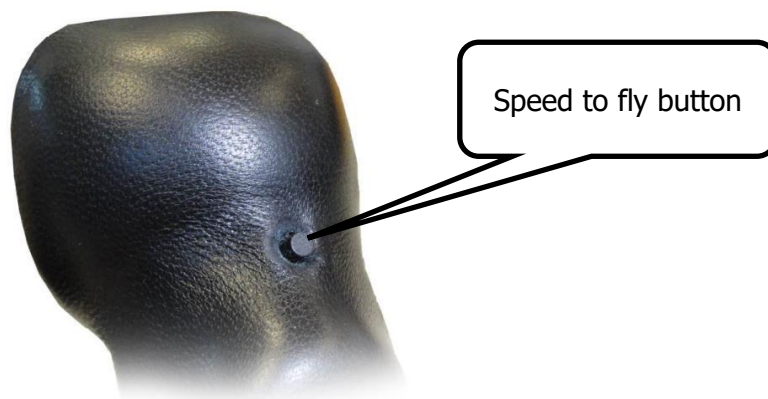

On the front side of remote stick there is speed to fly button.

13.5.2 Installation



For more detailed instructions on installation, please refer to installation manual.

The remote stick is connected to the RS485 bus through a RS485 splitter. Be careful to connect the correct coloured wire to the pin which is marked with same colour. RS485 is then connected with CAN BUS to your LX80xx/90xx instrument.

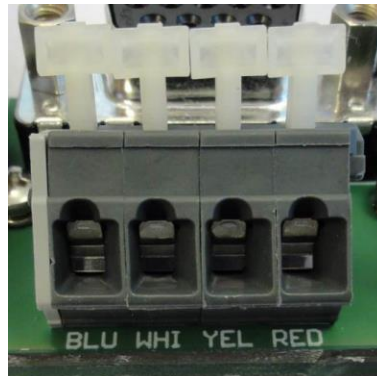

PTT wires are connected to the radio push to talk input and the SC wire is connected to the Speed to fly input of the vario unit.



Do not forget to set the speed command input setting to TASTER (see Chapter 5.1.12.1).



After installation there is no special setting required on the main display unit as the remote stick will be automatically detected.

13.6 Compass

The compass module must be connected to the RS485 bus. It must be installed at a location where there are no strong magnetic fields (iron or ferromagnetic materials), cables with AC current or varying DC currents.



When installing the magnetic compass use screws made of non-ferromagnetic materials (plastic or brass),



Orientation of compass module marked on the housing as on the picture above.



For more detailed instructions on installation, please refer to installation manual.

13.7 Flap Sensor®

The flap encoder is connected to the system via the RS485 bus. It is physically mounted near the flap mechanism. The flap encoder is very sensitive and accurate and can detect very small movements.



Please refer to flap sensor manual for details about installation. For configuration on the main display unit see Chapter 5.1.12.13.



For more detailed instructions on installation, please refer to installation manual.

13.8 Secondary Vario Indicators

An unlimited number of secondary vario indicators can be connected to the system bus. RS485 splitting units should be used to extend the bus capacity. The functionality of secondary units depends on settings made in setup (see Chapter 0).

Each unit has two female nine-pin connectors on the back side. Both connectors are 100% pin to pin compatible and it does not matter which will be used. Any other RS485 bus operated unit can be any time connected to a free connector port of the vario indicator.

14 Revision History

Rev	Date	Comments
1	September 2010	Initial release of owner manual based on LX9000 manual version 2.3
2	April 2011	Corrections to English language text. V5 vario unit
3	September 2011	Updates for firmware version 2.6. Added AHRS section.
4	February 2014	Updates for firmware version 4.0.
5	December 2014	Added chapters for LX9050 simple
6	June 2015	Installation part of manual moved to separate document. Merged document with LX80xx manual. Updates for firmware version 5.0.
7	January 2015	Added chapter 6.2.2
8	January 2017	Reviewed/updated chapters: 5.1.2, 5.1.6, 5.1.10.3, 5.1.12.1.1.1, 5.1.12.5, 5.1.12.10, 5.1.19, 5.4.1, 5.1.7.6, 6.3.25 New features/updated chapters: 0, 5.1.6.13, 5.1.7.1, 5.1.7.8, 5.1.7.10, 5.1.10.5, 5.1.10.6, 0, 6.2.1.13, 6.3.1.1, 0, 6.3.4.1, 6.3.26, 9.2.7, 10.1.1
9	March 2017	New chapter: 1.1.1
10	April 2017	Reviewed/updated chapters: 5.1.12.9, 10.2, 5.1.7.1, 5.1.12.4, 5.1.14
11	May 2017	Reviewed/updated chapters: 0, 5.1.12.4, 2.1.3, 2.1.4 5.1.12.1.1.2
12	June 2017	10.2.3
13	December 2017	Corrections to English language text.
14	February 2018	Reviewed/updated chapters: 5.1.5.6.1, 5.1.5.6.2, 5.1.6.3, 5.1.11.4.2.5, 5.1.12.1.1.2, 5.1.11.7, 5.1.13, 5.1.15, 5.7.2.3, 6.3.1, 6.3.4, 6.3.25,
15	March 2018	Added chapter: 5.1.11.17 Reviewed/updated chapter: 8
16	May 2018	Reviewed/Updated chapters: 5.1.12.11, 5.1.12.2, 6.3.1.1
17	July 2018	Added chapters: 5.1.14, 5.1.6.9.1, 5.1.6.9.2 Updated chapters: 5.1.6.2, 5.7.2.3, 5.1.2, 6.3
18	January 2019	Added chapters: 5.1.5.3, 5.1.6.9.5, 5.1.13.4, 5.1.14.2, 5.7.2.1 Reviewed/Updated chapters: 5.1.6.9, 5.1.11.7, 5.1.11.11, 5.1.13, 5.5.4, 6.2.1.1, 6.3.1
19	June 2019	Added chapters: 5.1.1.3, 0, 0, 5.1.19.1, 5.1.6.7.1.1, 13.3, Reviewed chapters: 5.1.12.6, 6.3.14, 5.1.15.4, 5.1.14.3, 6.3.7, 5.1.18, 0, 0, 5.1.6.6, 5.1.14.1, 5.1.17, 5.1.12.4, 0, 0, 5.1.12.4.1.1, 0, 0, 0, 0, 5.5.6.1, 5.3
20	August 2019	Updated Ch. 5.1.12.4.1.2
21	September 2019	Updated Ch. 0
22	October 2019	Updated Ch. 10.1,13.1.2
23	December 2019	Updated Ch. 5.7.2.4, 6.2.1.10, 5.1.11.1.1, 5.2.2, 8 Added chapter: 2.1.1.1
24	December 2019	Updated Ch. 5.1.8

25	January 2020	Updated Ch. 5.1.14.3
26	January 2020	Updated ch. 5.1.12.6, 5.1.7.2
27	February 2020	Updated ch. 0
28	April 2020	Updated ch. 6.3.19, 6.2.1.9, 6.2, 5.1.15.2 Added ch. 0
29	May 2020	Updated manual to version 8. Added Weight and balance setup and calculation (chapter 5.1.3, 5.1.13 and 7). Compass calibration procedure (chapter 5.1.12.7). Removed OLC upload (chapter 5.1.15.2 and 5.1.6.8).
30	July 2020	Updated ch. 5.1.15.2, 11.1.3, 6.2.1.4, 5.1.10.5, 6.3.23, 5.1.7.2, 5.1.8.1, 9.1
31	August 2020	Updated ch. 5.3, minor fixes
32	September 2020	Updated ch. 5.1.12.12, 5.1.14.1
33	September 2020	Style update
34	October 2020	Updated chapters 5.1.10.1, 5.1.14, 5.1.17, 8.2.6
35	November 2020	Updated chapters 5.1.17, 7.3
36	December 2020	Updated chapter 5.1.7.4 (Required Mc)
37	December 2020	Added chapter 5.1.15.5
38	March 2021	Added LX8030 and LX8040, minor fixes
39	April 2021	Updated chapter: 5.1.7.10
40	April 2021	Updated chapter: 5.4.2, 2.1.9.4, 2.9.1.5
41	May 2021	Minor fixes
42	May 2021	Updated PEV task start procedure.
43	July 2021	Updated chapters: 5.1.10.3, 5.1.17, 5.1.7.2, 5.1.6.7
44	August 2021	Updated ch. 5.1.17
45	January 2022	Added chapters about HAWK and HAWK setup
46	February 2022	Added misc passwords
47	April 2022	Updated HAWK chapters, Corrected Ch 5.1.1.3
48	April 2022	Added chapter 13.1.7
49	September 2022	Added chapter 4.1.5,14.1 Updated: 5.1.15.2, 5.1.12.14, 13.1.6
50	November 2022	Updated chapter 8.7.4
51	December 2022	Updated chapters 2.1.9, 5.1.6.3, 5.1.15.3, 5.1.12.6, 5.1.12.4.1.8, 6.3.2, 9.2.1.2
52	May 2023	Updated Ch. 6.3.1.1, added HAWK reset, added Map symbols. Updated to Version 9.05
53	June 2023	Updated chapter 5.7.2.4

14.1 END OF LIFE (EOL) devices

Device	Latest available manual
LXxxxx GEN1	Version 5
LXxxxx GEN2	Version 8

The pilot's choice



LXNAV d.o.o.

Kidričeva 24, SI-3000 Celje, Slovenia

T: +386 592 334 00 | F:+386 599 335 22 | info@lxnav.com

www.lxnav.com